

Spezifikation für Freigabe / specification for release

Kunde / customer :
 Artikelnummer / part number :

744851221



Bezeichnung : **Ringkern-Doppeldrossel WE-DCT**
 description : **Toroidal Double Power Choke WE-DCT**

DATUM / DATE : 2011-02-24

A Mechanische Abmessungen / dimensions:

	Type SH
--	----------------

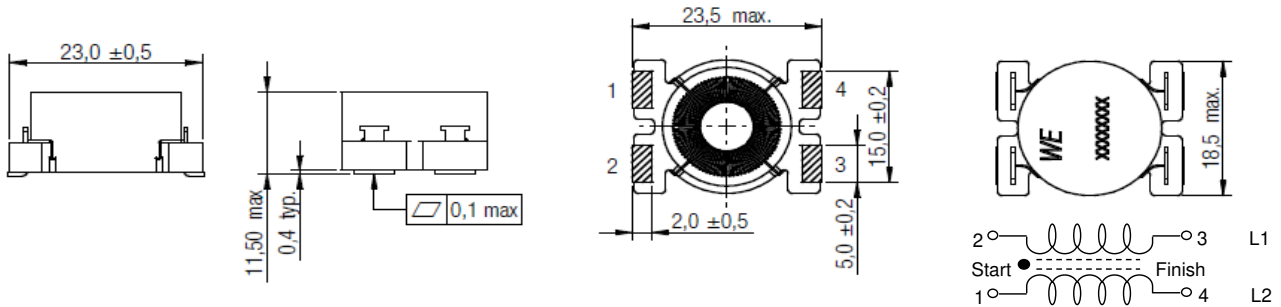

B Elektrische Eigenschaften / electrical properties:

C Lötpad / soldering spec.:

Eigenschaften / properties	Testbedingungen / test conditions		Wert / value	Einheit / unit	tol.
Induktivität (je Wicklg.) / inductance (each wdg.)	100 kHz / 5mA	L ₁ , L ₂	22,0	μH	+/-10%
DC-Widerstand (je Wicklg.) / DC-resistance (each wdg.)	@ 20°C	R _{DC1,2 typ}	34,0	mΩ	typ.
DC-Widerstand (je Wicklg.) / DC-resistance (each wdg.)	@ 20°C	R _{DC1,2 max}	45,0	mΩ	max.
Nennstrom (je Wicklg.) ⁽¹⁾ / rated Current (each wdg.) ⁽¹⁾	ΔT = 40 K	I _{R1} , I _{R2}	3,5	A	typ.
Sättigungsstrom (je Wicklg.) / saturation current (each wdg.)	ΔL/Lo -30%	I _{sat}	2,7	A	max.
Eigenres.-Frequenz / self-res.-frequency		f _{res}	16	MHz	typ.

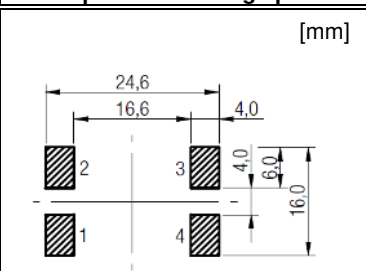

⁽¹⁾ Stromfluss durch beide Wicklungen verursacht ΔT / both windings driven by rated current will occur ΔT

D Prüfgeräte / test equipment:

- WAYNE KERR 3260B** für/for L; I_{sat}
- Dostmann T900** für/for I_{R1}; I_{R2}
- GMC Metrahit 271** für/for R_{DC}
- Agilent E4991A** für/for f_{res}

E Testbedingungen / test conditions:

- Luftfeuchtigkeit / humidity: 33%
- Umgebungstemperatur / temperature: +20°C

F Werkstoffe & Zulassungen / material & approvals:

- Gehäuse / housing: UL94 V-0
- Draht / wire: Class F
- Kleber / glue: UL94-HB
- Kern / Core: 1S125 (WE-PERM)

G Eigenschaften / general specifications:

- Betriebstemp. / operating temperature: -40°C - +125°C
- Umgebungstemp. / ambient temperature: -40°C - +85°C
- It is recommended that the temperature of the part does not exceed 125°C under worst case operating conditions.

Freigabe erteilt / general release:	Kunde / customer	
.....
Datum / date	Unterschrift / signature	
	Würth Elektronik	
.....
Geprüft / checked	Kontrolliert / approved	CZ Version 1 11-02-24
		Name Änderung / modification Datum / date

Würth Elektronik eiSos GmbH & Co. KG

D-74638 Waldenburg · Max-Eyth-Strasse 1 · Germany · Telefon (+49) (0) 7942 - 945 - 0 · Telefax (+49) (0) 7942 - 945 - 400
<http://www.we-online.de>

Spezifikation für Freigabe / specification for release

Kunde / customer :
 Artikelnummer / part number : **744851221**
 Bezeichnung : **Ringkern-Doppeldrossel WE-DCT**
 description : **Toroidal Double Power Choke WE-DCT**



DATUM / DATE : 2011-02-24

H Induktivitätskurve / Inductance curve:

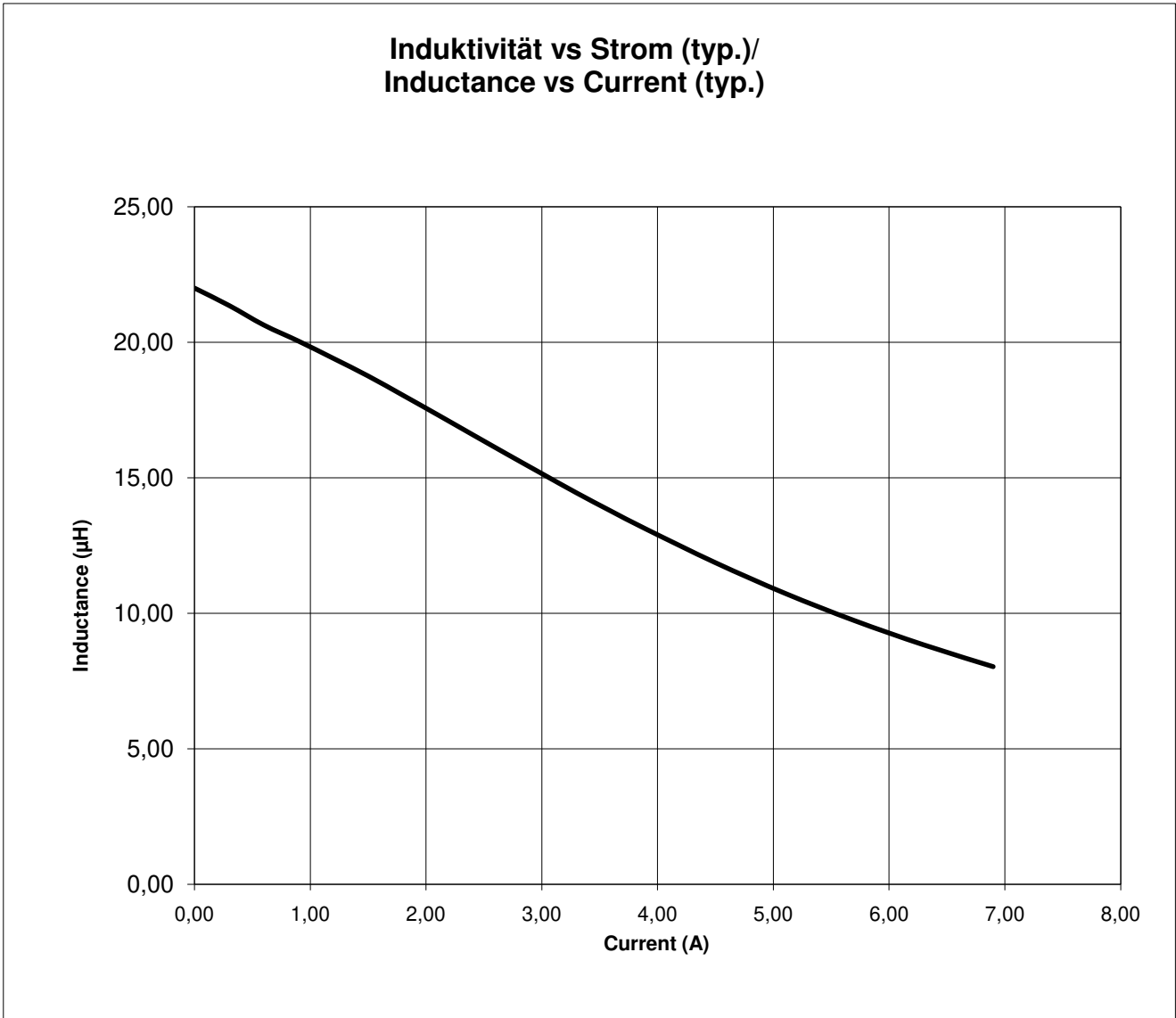

Freigabe erteilt / general release:	Kunde / customer			
.....			
Datum / date	Unterschrift / signature			
	Würth Elektronik			
.....			
Geprüft / checked	Kontrolliert / approved	CZ	Version 1	11-02-24
		Name	Änderung / modification	Datum / date

Würth Elektronik eiSos GmbH & Co. KG

D-74638 Waldenburg · Max-Eyth-Strasse 1 · Germany · Telefon (+49) (0) 7942 - 945 - 0 · Telefax (+49) (0) 7942 - 945 - 400
<http://www.we-online.de>

Spezifikation für Freigabe / specification for release

Kunde / customer :
 Artikelnummer / part number : **744851221**
 Bezeichnung : **Ringkern-Doppeldrossel WE-DCT**
 description : **Toroidal Double Power Choke WE-DCT**



DATUM / DATE : 2011-02-24

J Rollenspezifikation / tape and reel specification:

Gurtspezifikation / Tape specification:



Rollenspezifikation / Reel specification:



Freigabe erteilt / general release:	Kunde / customer			
Datum / date	Unterschrift / signature			
	Würth Elektronik			
Geprüft / checked	Kontrolliert / approved	CZ	Version 1	11-02-24
		Name	Änderung / modification	Datum / date

Würth Elektronik eiSos GmbH & Co. KG

D-74638 Waldenburg · Max-Eyth-Strasse 1 · Germany · Telefon (+49) (0) 7942 - 945 - 0 · Telefax (+49) (0) 7942 - 945 - 400
<http://www.we-online.de>