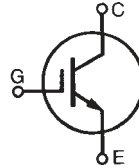


# HiPerFAST™ IGBT

## B2-Class High Speed IGBTs

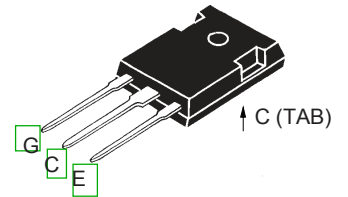
IXGH 50N90B2  
IXGT 50N90B2

$$\begin{aligned} V_{CES} &= 900 \text{ V} \\ I_{C25} &= 75 \text{ A} \\ V_{CE(sat)} &= 2.7 \text{ V} \\ t_{fi\text{typ}} &= 200 \text{ ns} \end{aligned}$$

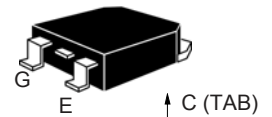


Symbol	Test Conditions	Maximum Ratings	
$V_{CES}$	$T_J = 25^\circ\text{C}$ to $150^\circ\text{C}$	900	V
$V_{CGR}$	$T_J = 25^\circ\text{C}$ to $150^\circ\text{C}$ ; $R_{GE} = 1 \text{ M}\Omega$	900	V
$V_{GES}$	Continuous	$\pm 20$	V
$V_{GEM}$	Transient	$\pm 30$	V
$I_{C25}$	$T_C = 25^\circ\text{C}$ (limited by leads)	75	A
$I_{C110}$	$T_C = 110^\circ\text{C}$	50	A
$I_{CM}$	$T_C = 25^\circ\text{C}$ , 1 ms	200	A
<b>SSOA</b> <b>(RBSOA)</b>	$V_{GE} = 15 \text{ V}$ , $T_{VJ} = 125^\circ\text{C}$ , $R_G = 10 \Omega$ Clamped inductive load @ $\leq 600\text{V}$	$I_{CM} = 100$	A
$P_C$	$T_C = 25^\circ\text{C}$	400	W
$T_J$		-55 ... +150	$^\circ\text{C}$
$T_{JM}$		150	$^\circ\text{C}$
$T_{stg}$		-55 ... +150	$^\circ\text{C}$
Maximum lead temperature for soldering 1.6 mm (0.062 in.) from case for 10 s		300	$^\circ\text{C}$
$M_d$	Mounting torque (TO-247)	1.13/10Nm/lb.in.	
<b>Weight</b>		TO-247 AD	6 g
		TO-268	4 g

TO-247  
(IXGH)



TO-268  
(IXGT)



G = Gate,  
E = Emitter,

C = Collector,  
TAB = Collector

### Features

- High frequency IGBT
- High current handling capability
- MOS Gate turn-on  
- drive simplicity

### Applications

- PFC circuits
- Uninterruptible power supplies (UPS)
- Switched-mode and resonant-mode power supplies
- AC motor speed control
- DC servo and robot drives
- DC choppers

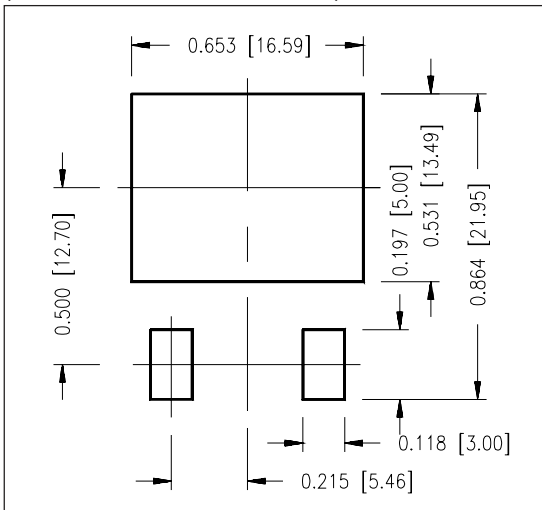
### Advantages

- High power density
- Very fast switching speeds for high frequency applications

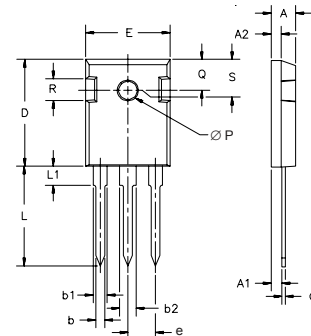
Symbol	Test Conditions	Characteristic Values ( $T_J = 25^\circ\text{C}$ , unless otherwise specified)		
		min.	typ.	max.
$V_{GE(th)}$	$I_C = 250 \mu\text{A}$ , $V_{CE} = V_{GE}$	3.0		5.0 V
$I_{CES}$	$V_{CE} = V_{CES}$ $V_{GE} = 0 \text{ V}$			50 $\mu\text{A}$ 1 mA
$I_{GES}$	$V_{CE} = 0 \text{ V}$ , $V_{GE} = \pm 20 \text{ V}$			$\pm 100 \text{ nA}$
$V_{CE(sat)}$	$I_C = I_{C110}$ , $V_{GE} = 15 \text{ V}$		2.2	2.7 V
				$T_J = 125^\circ\text{C}$

Symbol	Test Conditions	Characteristic Values ( $T_J = 25^\circ\text{C}$ , unless otherwise specified)			
		min.	typ.	max.	
$g_{fs}$	$I_C = I_{C110} A$ ; $V_{CE} = 10\text{ V}$ , Pulse test, $t \leq 300\ \mu\text{s}$ , duty cycle $\leq 2\%$	25	40	S	
$C_{ies}$ $C_{oes}$ $C_{res}$	$V_{CE} = 25\text{ V}$ , $V_{GE} = 0\text{ V}$ , $f = 1\text{ MHz}$		2500	pF	
			180	pF	
			75	pF	
$Q_g$ $Q_{ge}$ $Q_{gc}$	$I_C = I_{C110} A$ , $V_{GE} = 15\text{ V}$ , $V_{CE} = 0.5 V_{CES}$		135	nC	
			23	nC	
			50	nC	
$t_{d(on)}$ $t_{ri}$ $t_{d(off)}$ $t_{fi}$ $E_{off}$	<b>Inductive load, <math>T_J = 25^\circ\text{C}</math></b>  $I_C = I_{C110} A$ , $V_{GE} = 15\text{ V}$ $V_{CE} = 720\text{ V}$ , $R_G = R_{off} = 5\ \Omega$		20	ns	
			28	ns	
			350	500	ns
			200		ns
			4.7	7.5	mJ
$t_{d(on)}$ $t_{ri}$ $E_{on}$ $t_{d(off)}$ $t_{fi}$ $E_{off}$	<b>Inductive load, <math>T_J = 125^\circ\text{C}</math></b>  $I_C = I_{C110} A$ , $V_{GE} = 15\text{ V}$ $V_{CE} = 720\text{ V}$ , $R_G = R_{off} = 5\ \Omega$		20	ns	
			28	ns	
			0.7		mJ
			400		ns
			420		ns
			8.7		mJ
$R_{thJC}$ $R_{thCK}$	(TO-247)		0.25	0.31 KW KW	

### Min. Recommended Footprint (Dimensions in inches and mm)

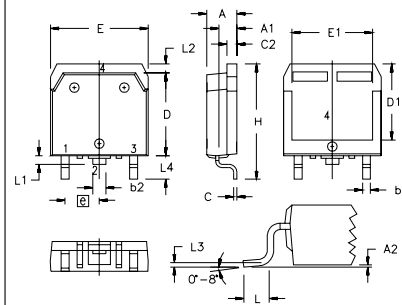


### TO-247 AD Outline



Dim.	Millimeter		Inches	
	Min.	Max.	Min.	Max.
A	4.7	5.3	.185	.209
A <sub>1</sub>	2.2	2.54	.087	.102
A <sub>2</sub>	2.2	2.6	.059	.098
b	1.0	1.4	.040	.055
b <sub>1</sub>	1.65	2.13	.065	.084
b <sub>2</sub>	2.87	3.12	.113	.123
C	.4	.8	.016	.031
D	20.80	21.46	.819	.845
E	15.75	16.26	.610	.640
e	5.20	5.72	0.205	0.225
L	19.81	20.32	.780	.800
L1		4.50		.177
∅P	3.55	3.65	.140	.144
Q	5.89	6.40	0.232	0.252
R	4.32	5.49	.170	.216
S	6.15	BSC	.242	BSC

### TO-268 Outline

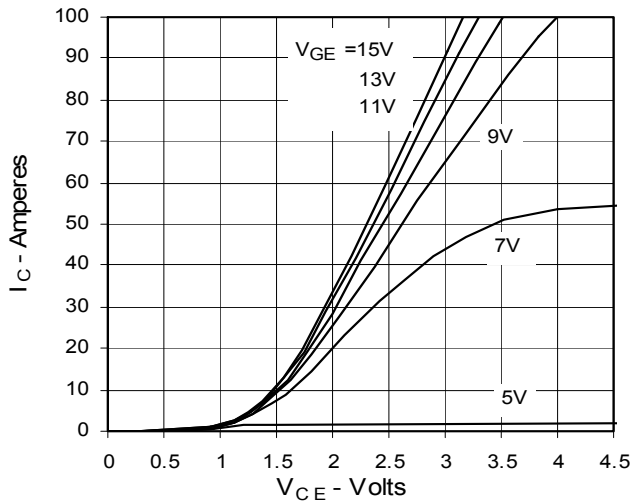


SYM	INCHES		MILLIMETERS	
	MIN	MAX	MIN	MAX
A	.193	.201	4.90	5.10
A1	.106	.114	2.70	2.90
A2	.001	.010	0.02	0.25
b	.045	.057	1.15	1.45
b2	.075	.083	1.90	2.10
C	.016	.026	0.40	0.65
C2	.057	.063	1.45	1.60
D	.543	.551	13.80	14.00
D1	.488	.500	12.40	12.70
E	.624	.632	15.85	16.05
E1	.524	.535	13.30	13.60
e	.215 BSC		5.45 BSC	
H	.736	.752	18.70	19.10
L	.094	.106	2.40	2.70
L1	.047	.055	1.20	1.40
L2	.039	.045	1.00	1.15
L3	.010 BSC		0.25 BSC	
L4	.150	.161	3.80	4.10

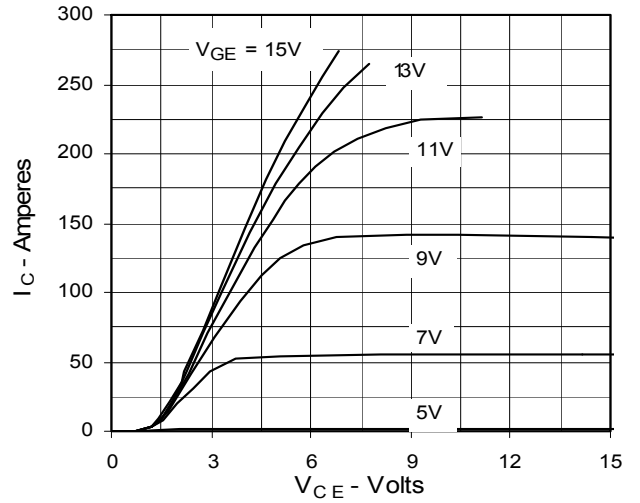
IXYS reserves the right to change limits, test conditions, and dimensions.

IXYS MOSFETs and IGBTs are covered by one or more of the following U.S. patents:	4,850,072	4,931,844	5,034,796	5,063,307	5,237,481	5,381,025	6,404,065B1	6,162,665	6,534,343	6,583,505
	4,835,592	4,881,106	5,017,508	5,049,961	5,187,117	5,486,715	6,306,728B1	6,259,123B1	6,306,728B1	6,683,344

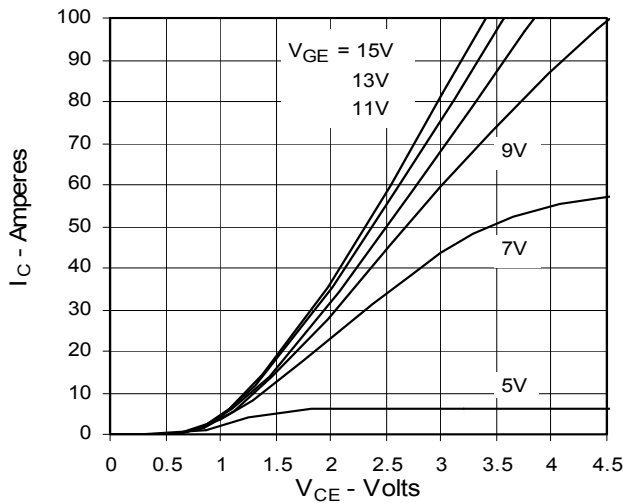
**Fig. 1. Output Characteristics**  
@ 25 °C



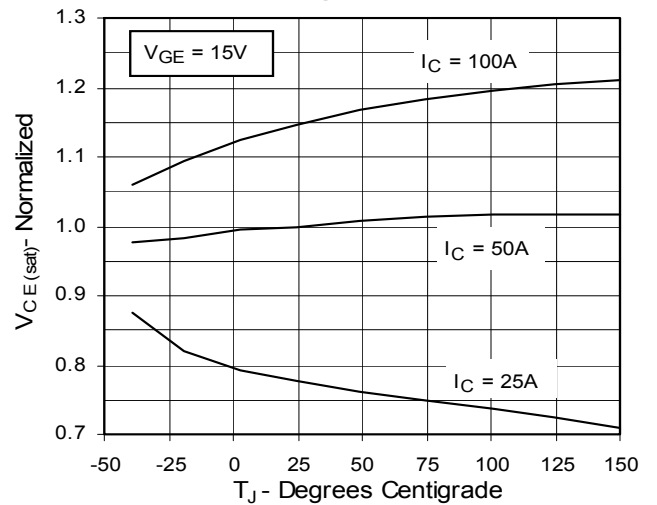
**Fig. 2. Extended Output Characteristics**  
@ 25 °C



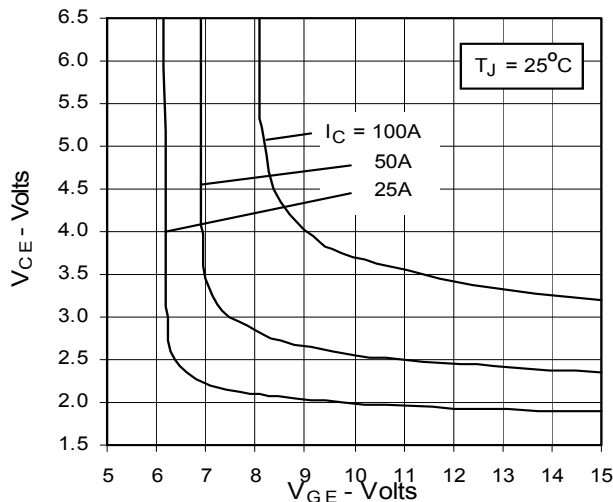
**Fig. 3. Output Characteristics**  
@ 125 °C



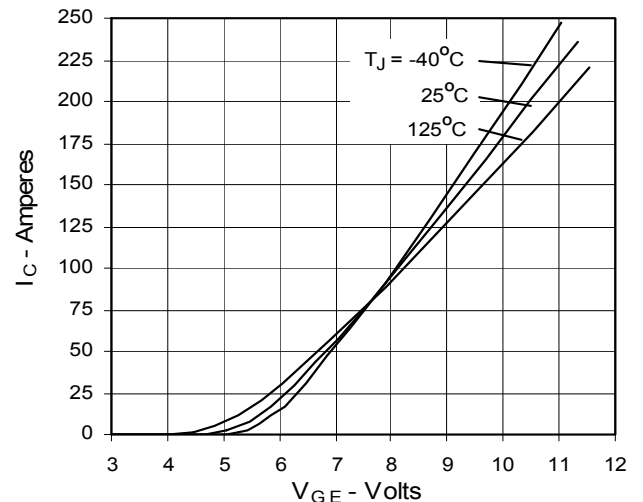
**Fig. 4. Dependence of  $V_{CE(sat)}$  on Temperature**



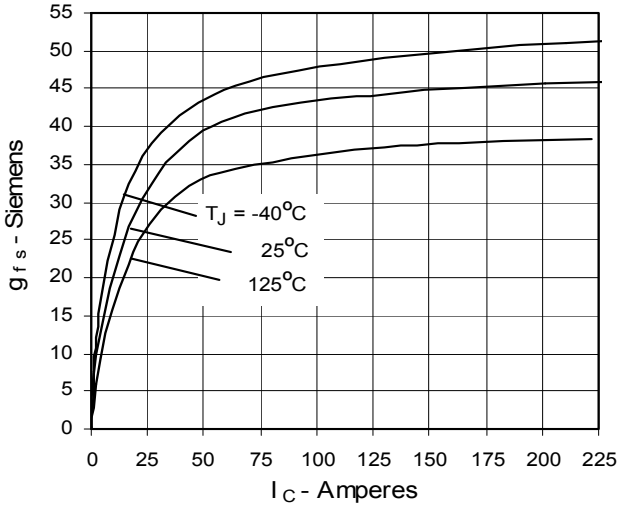
**Fig. 5. Collector-to-Emitter Voltage vs. Gate-to-Emitter voltage**



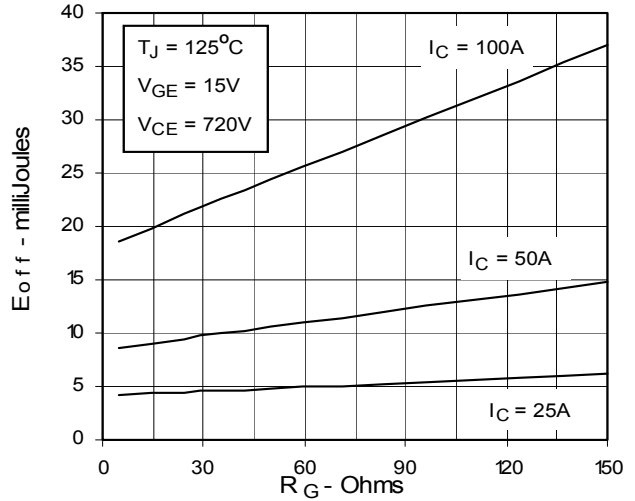
**Fig. 6. Input Admittance**



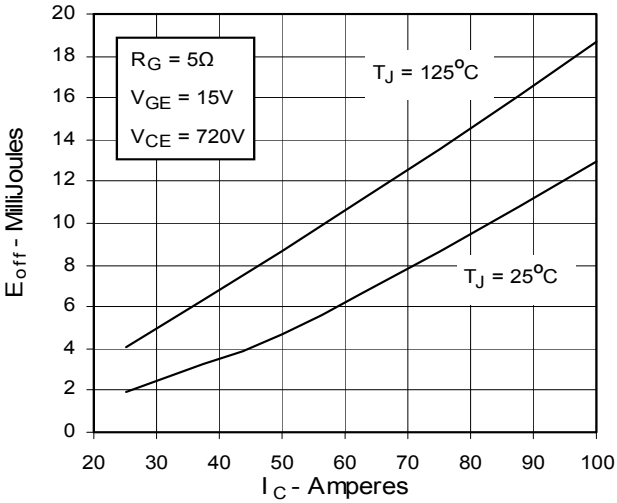
**Fig. 7. Transconductance**



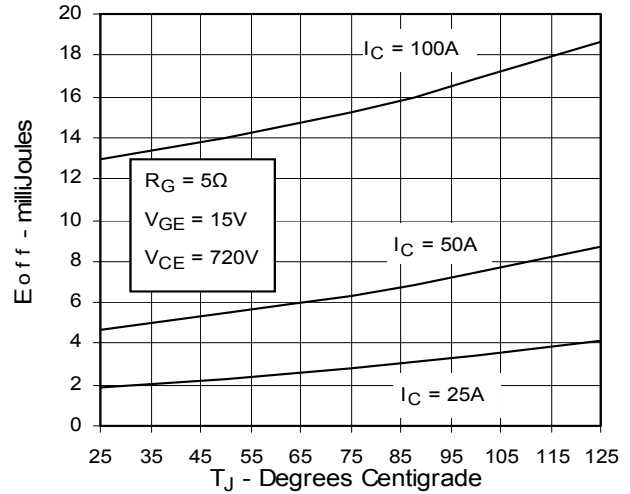
**Fig. 8. Dependence of Turn-off Energy Loss on  $R_G$**



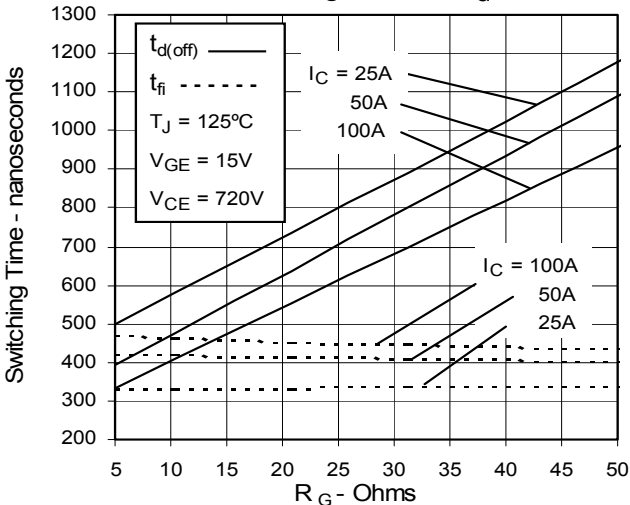
**Fig. 9. Dependence of Turn-Off Energy Loss on  $I_C$**



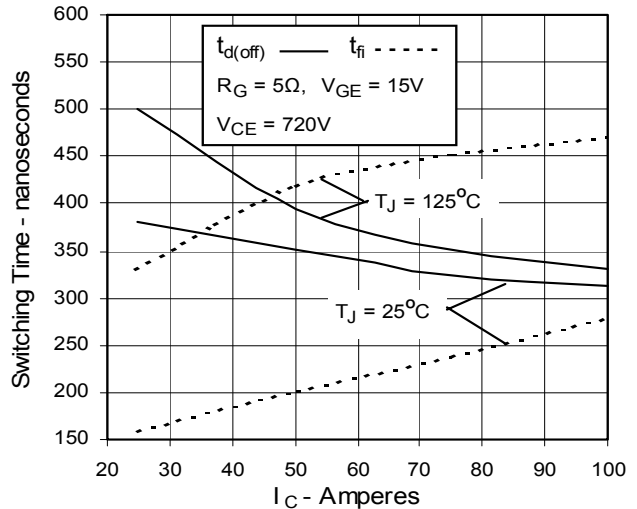
**Fig. 10. Dependence of Turn-off Energy Loss on Temperature**



**Fig. 11. Dependence of Turn-off Switching Time on  $R_G$**

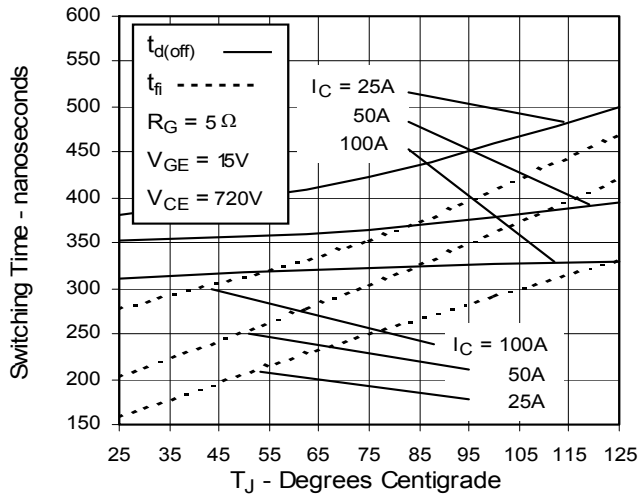


**Fig. 12. Dependence of Turn-off Switching Time on  $I_C$**

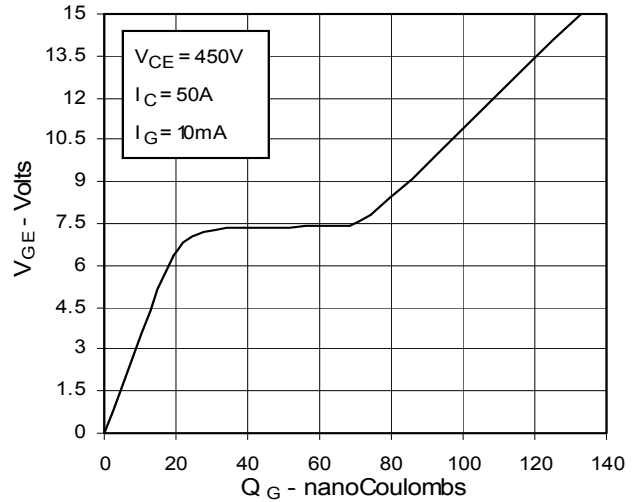


IXYS reserves the right to change values, specifications, and dimensions

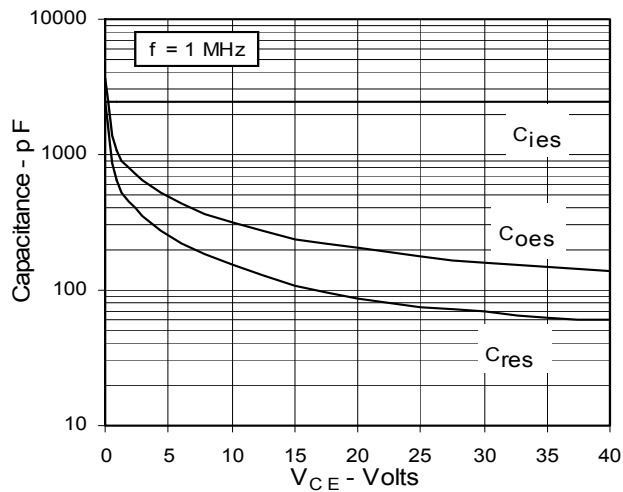
**Fig. 13. Dependence of Turn-off Switching Time on Temperature**



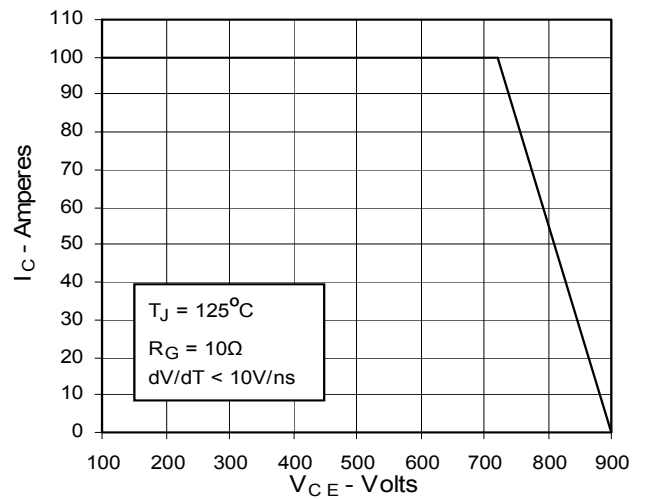
**Fig. 14. Gate Charge**



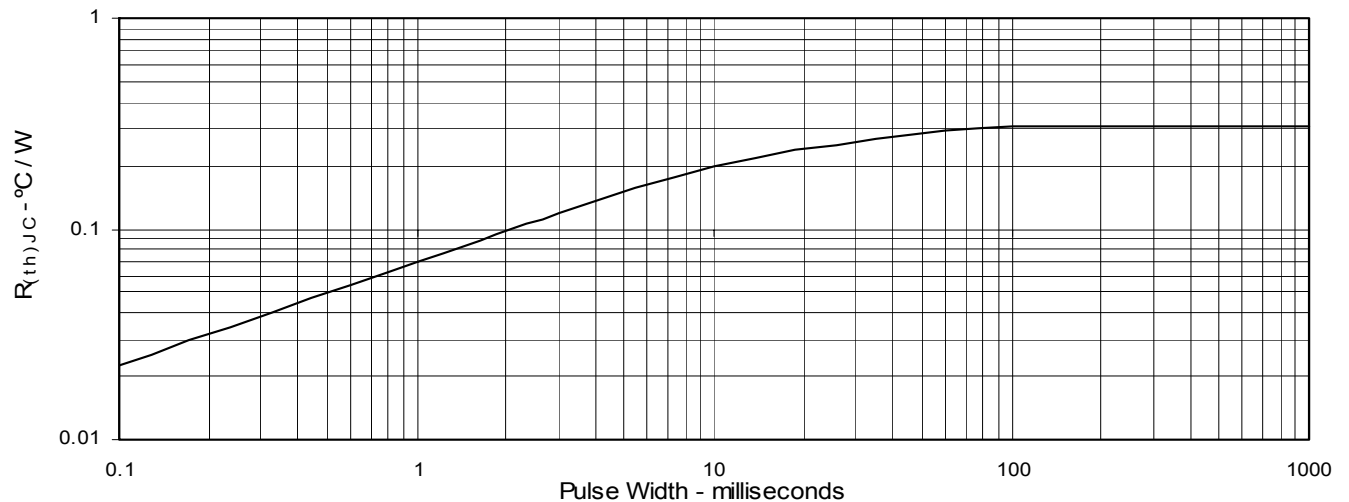
**Fig. 15. Capacitance**



**Fig. 16. Reverse-Bias Safe Operating Area**



**Fig. 17. Maximum Transient Thermal Resistance**





---

Disclaimer Notice - Information furnished is believed to be accurate and reliable. However, users should independently evaluate the suitability of and test each product selected for their own applications. Littelfuse products are not designed for, and may not be used in, all applications. Read complete Disclaimer Notice at [www.littelfuse.com/disclaimer-electronics](http://www.littelfuse.com/disclaimer-electronics).