

SAC-3P- 3,0-PUR/M 8FR SH

Order No.: 1521779

<http://eshop.phoenixcontact.de/phoenix/treeViewClick.do?UID=1521779>

Sensor/Actuator cable, 3-position, PUR, halogen-free, Black-gray RAL 7021, shielded, Free conductor end, on Socket, angled M8, Cable length: 3 m

Commercial data

GTIN (EAN)	4017918968762
Note	Made-to-order
sales group	D117
Pack	1 pcs.
Customs tariff	85444290
Weight/Piece	0.1068 KG
Catalog page information	Page 79 (PC-2009)

Product notes

WEEE/RoHS-compliant since:
11/20/2007



<http://www.download.phoenixcontact.com>
Please note that the data given here has been taken from the online catalog. For comprehensive information and data, please refer to the user documentation. The General Terms and Conditions of Use apply to Internet downloads.

Technical data

General data

Rated current at 40°C	4 A
Rated voltage	60 V
Number of positions	3
Volume resistance	≤ 5 mΩ

Insulation resistance	≥ 100 MΩ
Length of cable	3 m
Stripping length of the free conductor end	50 mm
Ambient temperature (operation)	-25 °C ... 90 °C (Male connector / female connector)

General characteristics

Standards/regulations	M8 male connector IEC 61076-2-104
Coding	A - standard
Surge voltage category	II
Pollution degree	3
Degree of protection	IP65/IP67/IP69K
Contact material	CuSn
Contact surface material	Ni/Au
Contact carrier material	TPU GF
Material of grip body	TPU, hardly inflammable, self-extinguishing
Material, knurls	Zinc die-cast, (nickel-plated)
Sealing material	NBR
Status display	No

Conductor data

Cable type	PUR halogen-free black shielded
Cable type (abbreviation)	PUR
Conductor cross section	0.25 mm ²
AWG signal line	24
Conductor structure signal line	32 x 0.10 mm
Core diameter including insulation	1.17 mm ±0.02 mm
External cable diameter	5.00 mm
Wire colors	Brown, blue, black
External sheath, color	Black-gray RAL 7021
Outer sheath, material	PUR
Conductor material	Bare Cu litz wires
Cable weight	33 kg/km
Smallest bending radius, fixed installation	50 mm
Smallest bending radius, movable installation	50 mm
Number of bending cycles	4000000
Bending radius	50 mm

Traversing path	10 m
Traversing rate	3 m/s
Acceleration	10 m/s ²
Ambient temperature (operation)	-40 °C ... 80 °C (cable, fixed installation) -5 °C ... 80 °C (cable, flexible installation)
Special properties	Flexible cable conduit capable Silicone-free Free of substances which would hinder coating with paint or varnish
Flame resistance	in accordance with DIN UL-Style 20549
Halogen-free	in accordance with DIN VDE 0472 part 815
Resistance to oil	in accordance with DIN EN 60811-2-1
Other resistance	Highly resistant to acids, alkaline solutions and solvents hydrolysis and microbe resistant

Certificates / Approvals



Certification

CUL Listed, UL Listed

Diagrams/Drawings

Diagram

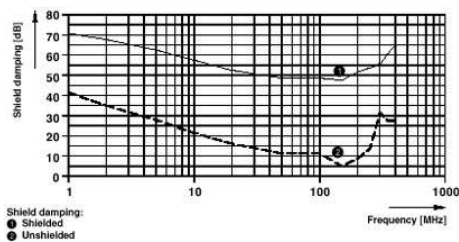

Dimensioned drawing

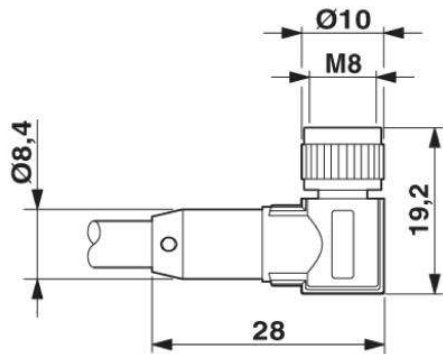

Socket M8 x 1, angled, shielded

Circuit diagram

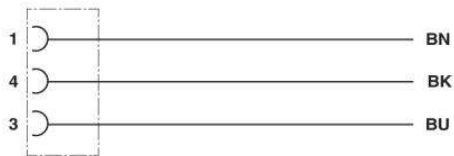

Contact assignment of M8 socket

Schematic diagram

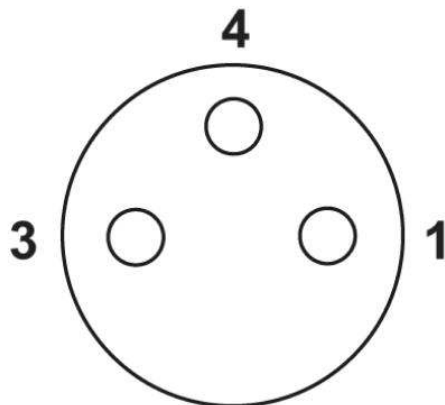

Pin assignment M8 socket, 3-pos., view female side

Address

PHOENIX CONTACT Inc., USA
586 Fulling Mill Road
Middletown, PA 17057, USA
Phone (800) 888-7388
Fax (717) 944-1625
<http://www.phoenixcon.com>



© 2010 Phoenix Contact
Technical modifications reserved;