

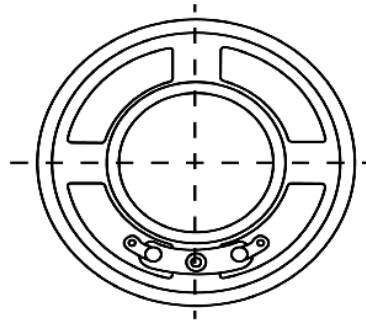

TOP VIEW

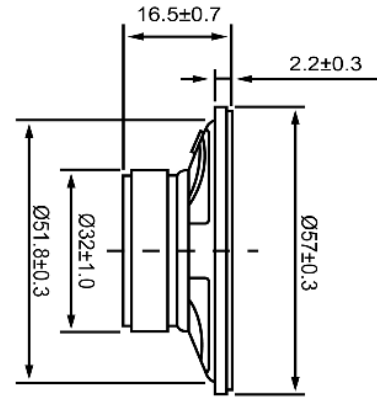

SIDE VIEW



Specifications			Notes	Revision History					
Description	Value	Unit		Version	Description		Date	Approved	
Shape	Round		1) All dimensions are in mm unless otherwise noted 2) All parts meet RoHS  DB UNLIMITED	1	Released from Engineering		2/5/2014	J.S.	
Resonant Frequency	420	(Hz)							
Frequency Range	420 ~ 5,000	(Hz)							
SPL @ 10cm	101	(dBA)							
Impedance	8	(Ohm)							
Cone Material	Paper								
Nominal Power	0.5	(W)							
Max Power	0.8	(W)							
Mount Type	Flush Mount								
Operating Temperature	-30 ~ +60	°C							
Storage Temperature	-30 ~ +60	°C							
Weight	45	(g)							
				Dynamic Speaker		SP570408-1			
				Drawn by	Date	Checked by	Date	Approved by	Date
				G.W.	1/27/2014	C.E.	2/5/2014	J.S.	2/5/2014

Additional considerations can be found at www.dbunlimitedco.com/technical-articles.