



324, 325, 326, 327, 328, 332 & 333 SERIES CAPS

1/2" SQUARE

CAP PART NO.	COLOR	FIG
324-0071	RED	1
324-0072	GREEN	1
324-0073	YELLOW	1
324-0075	WHITE	1

5/8" x 3/4" RECTANGULAR

CAP PART NO.	COLOR	FIG
333-0071*	RED	2
333-0072*	GREEN	2
333-0073*	YELLOW	2
333-0075*	WHITE	2

* Has Fingertip Grips

5/8" SQUARE

CAP PART NO.	COLOR	FIG
325-0071	RED	3
325-0072	GREEN	3
325-0073	YELLOW	3
325-0075	WHITE	3

3/4" SQUARE

CAP PART NO.	COLOR	FIG
327-0071	RED	4
327-0072	GREEN	4
327-0073	YELLOW	4
327-0075	WHITE	4

5/8" SQUARE LED

CAP PART NO.	LED/CAP	FIG
332-0010	RED/BLACK	5
332-0015	RED/WHITE	5
332-0020	GREEN/BLACK	5
332-0030	YELLOW/BLACK	5

3/4" x 1" RECTANGULAR

CAP PART NO.	COLOR	FIG
328-0071	RED	6
328-0072	GREEN	6
328-0073	YELLOW	6
328-0075	WHITE	6

5/8" x 3/4" RECTANGULAR

CAP PART NO.	COLOR	FIG
326-0071	RED	7
326-0072	GREEN	7
326-0073	YELLOW	7
326-0075	WHITE	7

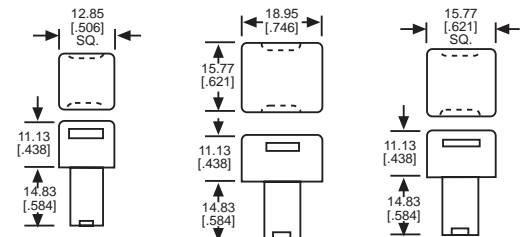

Fig 1

Fig 2

Fig 3

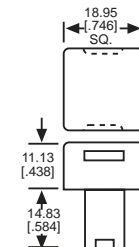

Fig 4

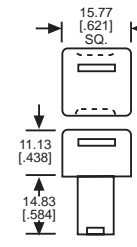

Fig 5

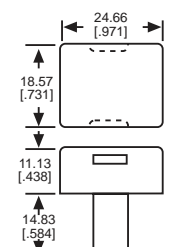

Fig 6

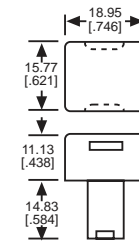

Fig 7

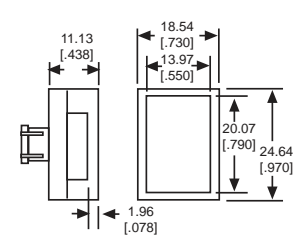

Fig. 8

Please contact factory for legend information available on Figures 1 thru 8.

329 & 330 SERIES CAP KITS

3/4" X 1" LEGEND KITS - SINGLE LAMP

KIT PART NO.	LENS/FILTER COLOR	FIG
329-0701-030	RED, GREEN, AMBER, BLUE/NONE	8
329-0701-037	CLEAR/NONE	8
329-0701-537	CLEAR/RED, GREEN, AMBER, BLUE	8

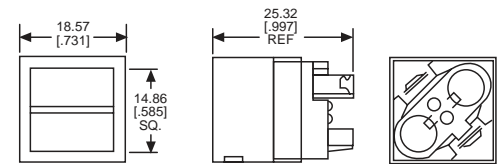

Fig 9

3/4" LEGEND KITS - DUAL LAMP

KIT PART NO.	LENS/FILTER COLOR	FIG
330-0100-100	RED, GREEN, AMBER, BLUE, WHITE/NONE	9
330-0255-155	(2) WHITE/RED, GREEN, AMBER, BLUE	9

Legends provided by Dialight Stocking Distributors

Material: Cap, High Temperature Scratch-Resistant Plastic

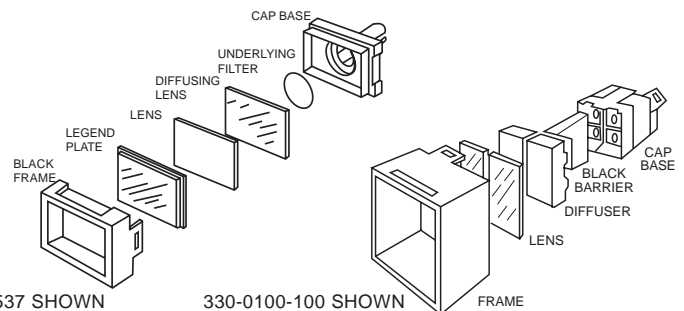

329-0701-537 SHOWN

330-0100-100 SHOWN

FRAME

