

PART NAME	NEMA 4X ENCLOSURE	PART No.	PNR-2607, PNR-2607-C AND PNR-2607-DG PNR-2608, PNR-2608-C AND PNR-2608-DG	REV. DATE	11-17-08
-----------	-------------------	----------	--	-----------	----------

INDUSTRY STANDARDS:  
 POLYCARBONATE (LIGHT GRAY AND CLEAR)  
 UL94-HB FLAMMABILITY RATING (UL FILE #E41613)  
 UV STABILIZED  
 SERVICE TEMPERATURE RANGE: -40°C TO +120°C  
 ABS (DARK GRAY)  
 UL94-HB FLAMMABILITY RATING (UL FILE #E56070)  
 SERVICE TEMPERATURE RANGE: -40°C TO +80°C

PART NUMBER	DIMENSION			
	A	B	C	D
PNR-2607, PNR-2607-C AND PNR-2607-DG	1.640	1.580	2.180	1.627
PNR-2608, PNR-2608-C AND PNR-2608-DG	2.425	2.365	2.965	2.412

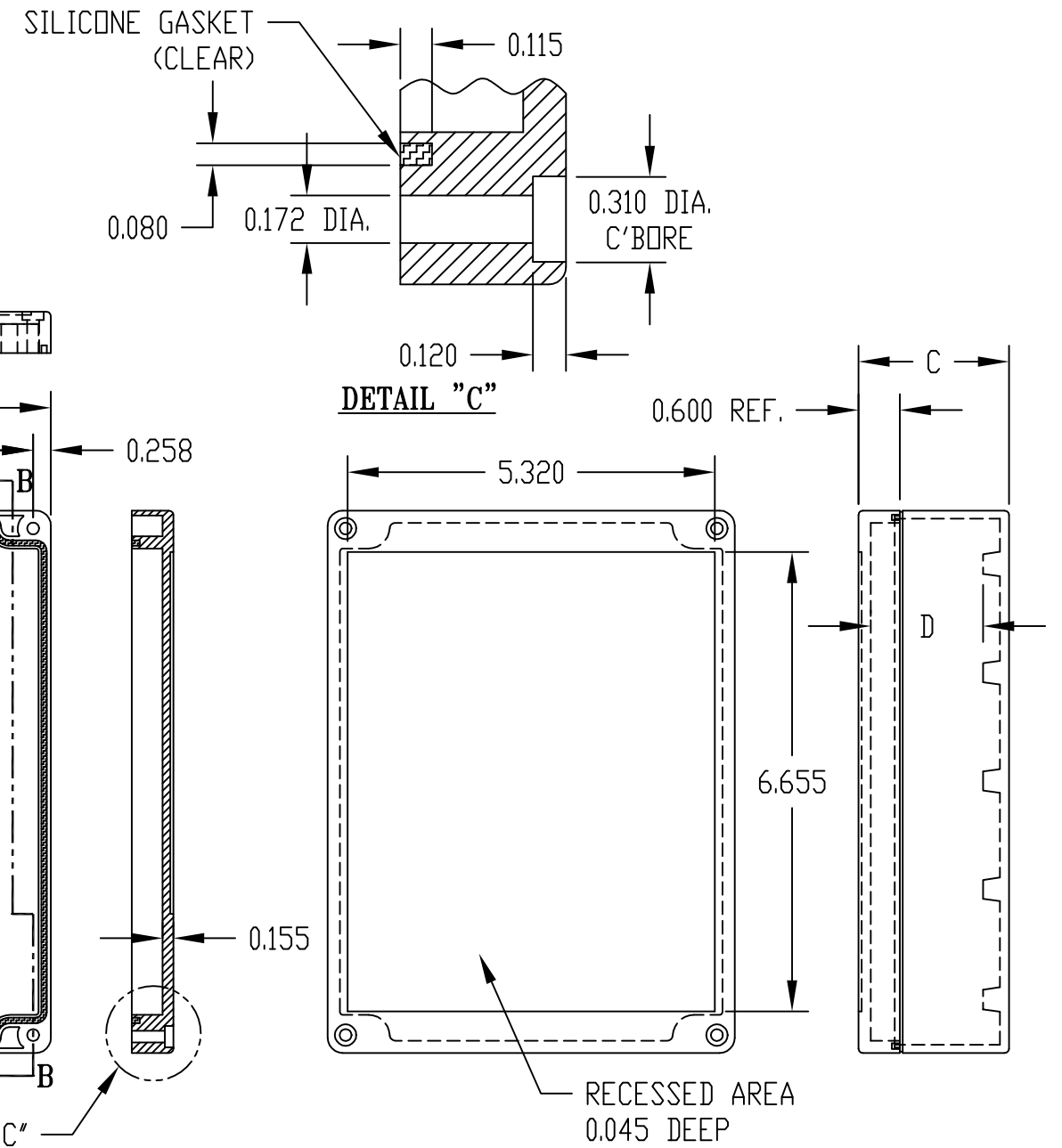
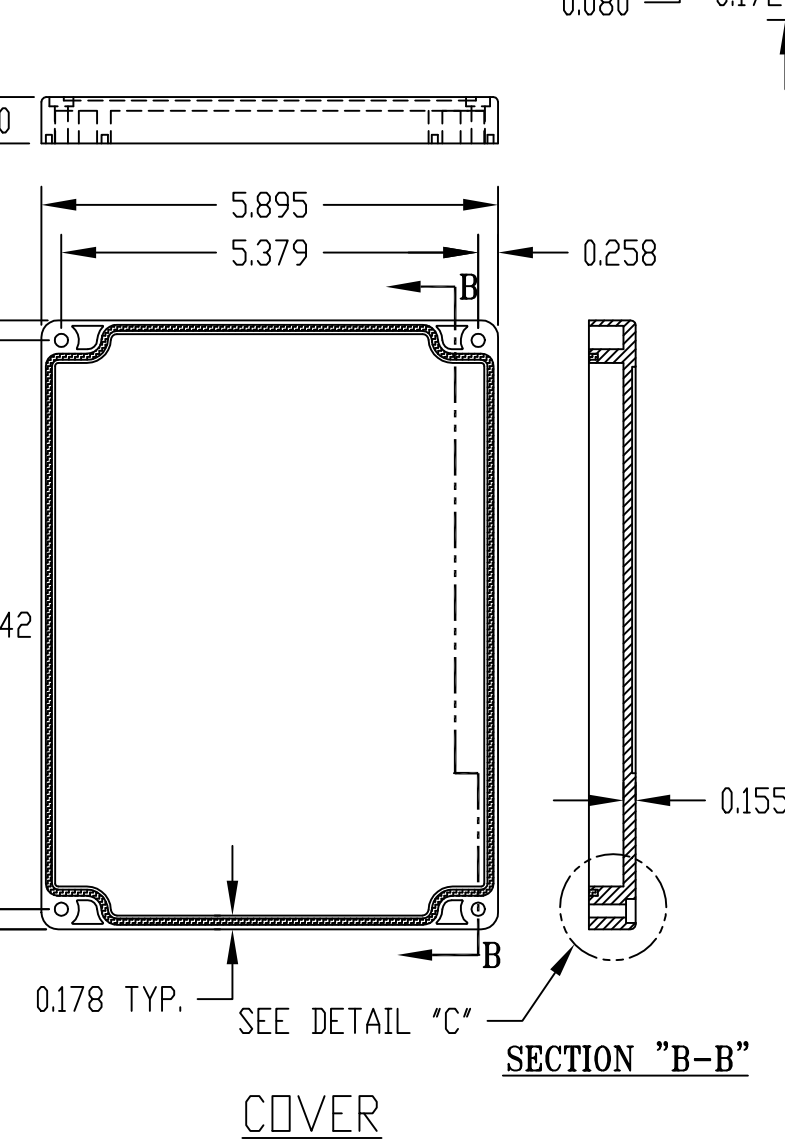
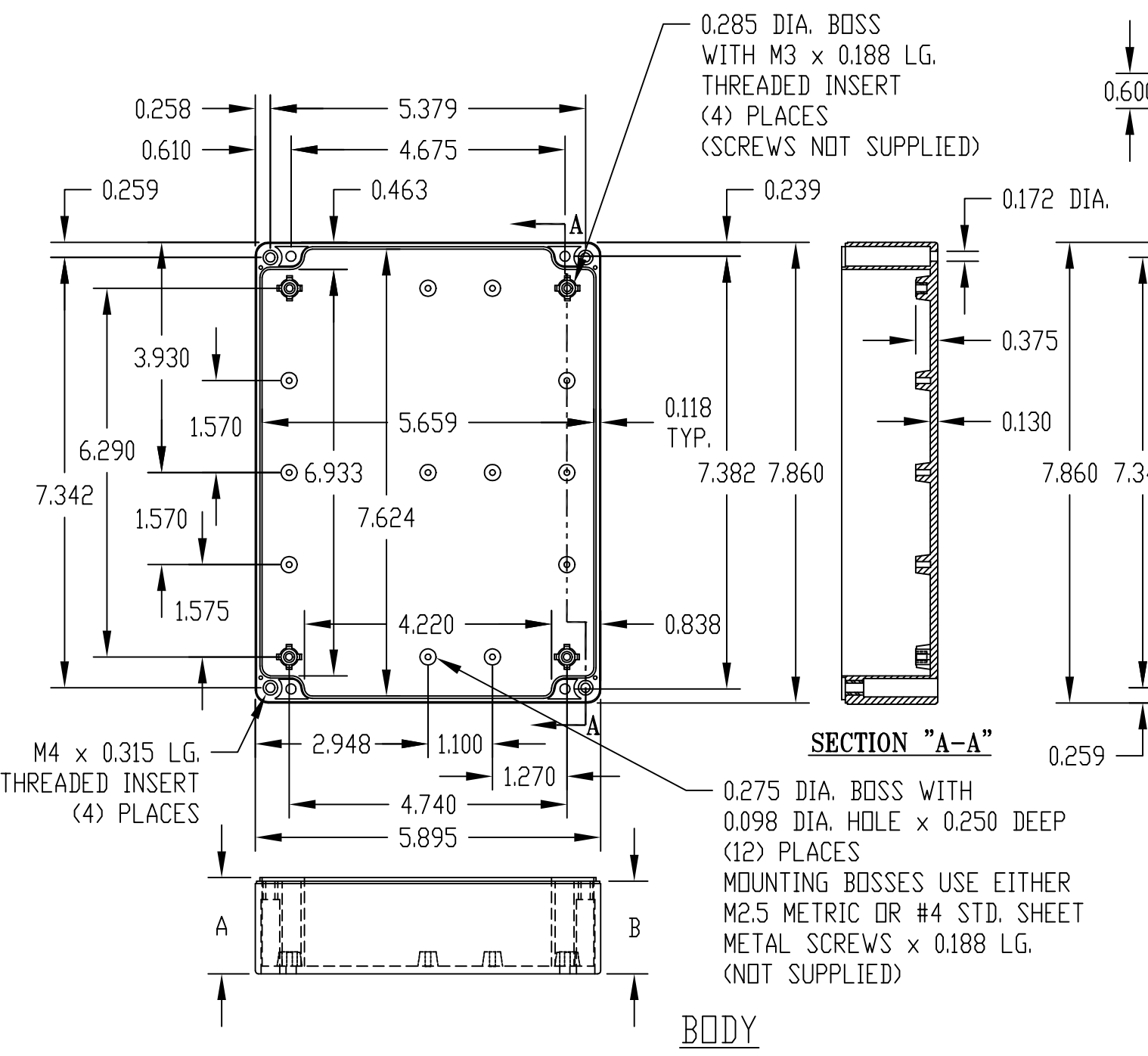

NOTE: ALL DIMENSIONS HAVE ±0.015 TOLERANCE UNLESS OTHERWISE SPECIFIED.

PART NUMBER	MATERIAL		FINISH		HARDWARE KIT
	BODY	COVER	BODY	COVER	
PNR-2607 & PNR-2608	POLYCARBONATE		LIGHT GRAY		KIT CONTAINS (4) M4 x 17mm (0.688") LG. SCREWS FOR ASSEMBLY
PNR-2607-C & PNR-2608-C	POLYCARBONATE		LIGHT GRAY	CLEAR	
PNR-2607-DG & PNR-2608-DG	HIGH-IMPACT ABS		DARK GRAY		