

# High Airflow Fan "San Ace 120" SG Type

Satoshi Fujimaki  
Jirou Watanabe

Toshiyuki Nakamura  
Yasuhiro Maruyama

Tetsuya Yamazaki

## 1. Introduction

In the market for information and communications equipment (PCs, servers, routers etc.), the increased density and increased heat generated by equipment have created a need for fans with higher air flow and higher static pressure, and so there is great demand for fans measuring 120mm sq.

To answer this need, Sanyo Denki has developed a 120mm sq. × 38mm thick fan that offers the highest air flow for this size fan in the industry (as of March 2005). The new fan offers greatly improved performance as compared to our conventional products in the series. This report presents an overview of the features of the newly developed high air flow San Ace 120 SG type fan.

## 2. Background to development

120mm sq. × 38mm thick was a groundbreaking size for cooling fans. For this reason, each company offers a series of multiple products of this size; Sanyo Denki has already marketed the R and G types in addition to the L and GL types that offer long service life. The maximum air flow for Sanyo Denki's 120mm sq. × 38mm thick fans was 5.1m<sup>3</sup>/min (180 CFM), and air flow performance above this level could not be anticipated. However, there continued to be strong market demand for high air flow fans, and a 120mm sq. × 38mm thick fan with a maximum air flow of over 5.66 m<sup>3</sup>/min (200 CFM) was needed.

In response to this demand, Sanyo Denki developed the San Ace 120 SG type 120mm sq. × 38mm thick fan that offers an air flow performance unmatched by existing products.



Fig. 1 San Ace 120 SG type fan

## 3. Features of developed product

Fig. 1 shows an external view of the San Ace 120 SG type fan.

The features of the product are as follows:

- (1) High air flow and high static pressure
- (2) Low ripple current due to 3-phase drive system

## 4. Product overview

### 4.1 Dimensional overview

Fig. 2 shows the product dimensional overview.

### 4.2 Features

#### 4.2.1 General features

Table 1 shows the general features of the newly developed fan. It offers three rated voltages: 12 V, 24 V and 48 V. The rated rotating speed is G speed (6000 min<sup>-1</sup>) only, but the product also offers PWM speed control and voltage instruction speed control to enable rotational speed control.

Table 1 General features (San Ace 120 SG type fan)

Model no.	Rated voltage	Operating voltage range	Rated current	Rated power	Rated rotational speed	Maximum air flow			Maximum static pressure		Sound pressure	Mass level
	V	V	A	W	min <sup>-1</sup>	m <sup>3</sup> /min	CFM	m <sup>3</sup> /h	Pa	inchH <sub>2</sub> O	dB(A)	g
9SG1212G102	12	10.2~13.8	4.0	48	6000	7.35	260	441	340	1.37	64	400
9SG1224G102	24	20.4~27.6	2.0	48	6000	7.35	260	441	340	1.37	64	400
9SG1248G102	48	40.8~55.2	1.0	48	6000	7.35	260	441	340	1.37	64	400

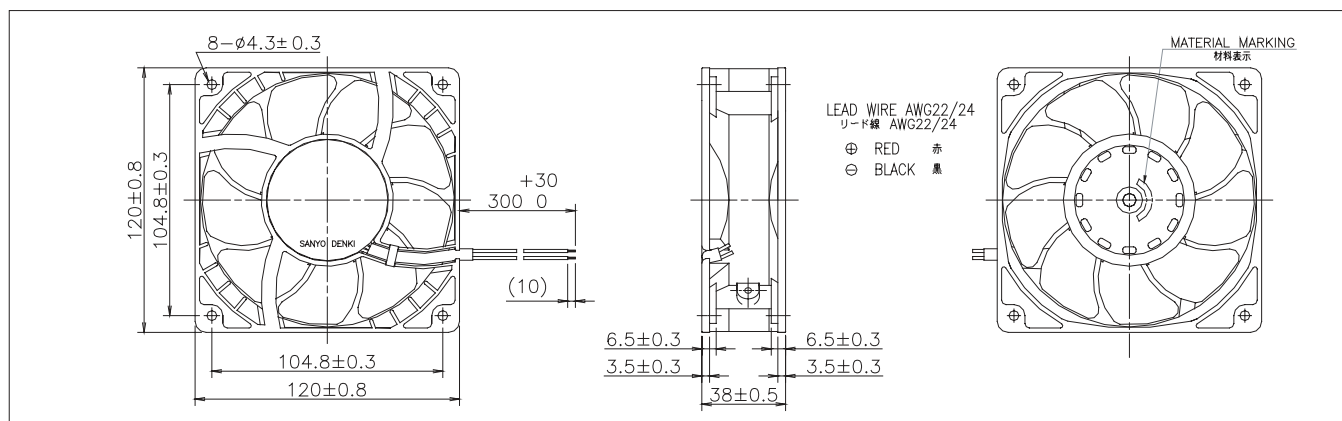

Fig. 2 Dimensional overview (San Ace 120 SG type fan)

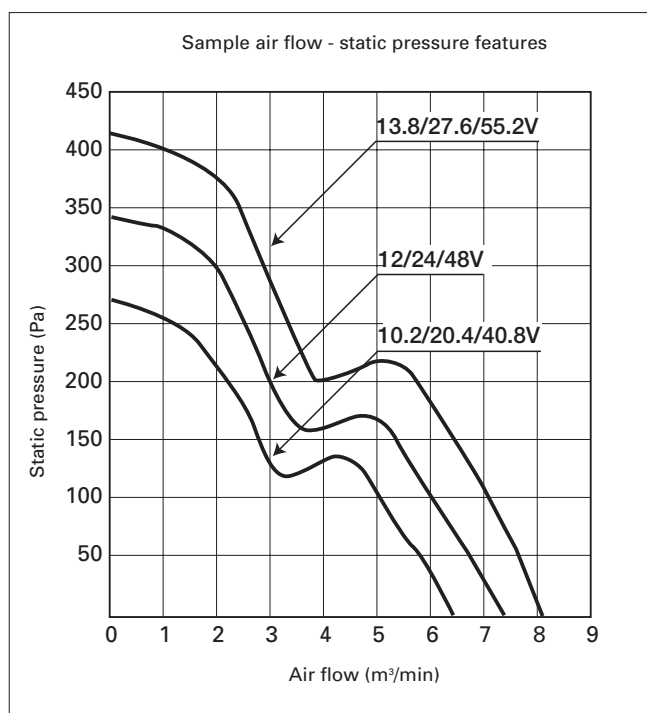

Fig. 3 Sample air flow - static pressure features (San Ace 120 SG type fan)

### 4.3 Air flow - static pressure features

Fig. 3 shows the air flow and static pressure features of the newly developed fan.

### 4.4 Life span of products

The expected life of the newly developed fan in an ambient temperature of 60 °C is 40,000 hours (survival rate 90%, continuous operation at rated voltage, free air state, ordinary humidity).

## 5. Comparison with conventional products

The newly developed fan greatly increases maximum air flow and maximum static pressure as compared to our conventional products. In the development process, the frame and blade design of the existing fan was greatly modified to create a new design. A 3-phase drive system was also adopted for the motor and electronic circuitry to achieve high output. The result is greatly improved performance.

### 5.1 Structural comparison

Fig. 4 shows the motor of the San Ace 120 SG type fan. Fig. 5 shows the motor of the existing San Ace 120L G type fan.

The motor of the new fan is a 12-slot, 3-phase motor with newly developed drive circuits. A high output motor is needed to achieve high air flow. From a cost standpoint, however, it was not possible to use expensive rare earth magnets and the like. For this reason, to increase motor output, either the motor core diameter had to be made larger, or the coil wire

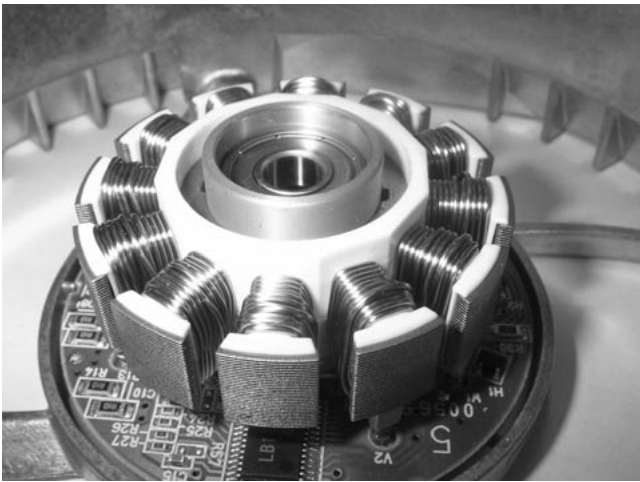

Fig. 4 Motor (San Ace 120 SG type fan)

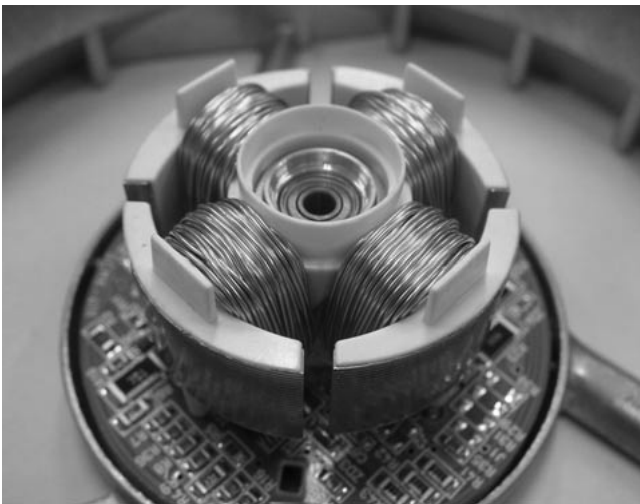

Fig. 5 Motor (conventional San Ace 120L G type fan)

diameter had to be made thicker. However, for this size fan, the motor core diameter was already at the limit. With regard to the coil diameter as well, in the case of the low drive voltage DC 12V specification, the wire diameter in the motor coil would have to be made even thicker, and with the existing 4-slot single-phase 4-electrode configuration, the coil might protrude from the coil end. For this reason, it was difficult to provide the necessary number of windings.

Accordingly, although in general fans use a 4-slot configuration which is advantageous in terms of cost, in this case we adopted a 12-slot design that allowed thick wire to be wound efficiently.

With regard to the drive circuits, the conventional products used a 2-phase half-wave or single-phase full-wave system. For the new fan, however, as shown in Fig. 6, a 3-phase full-wave

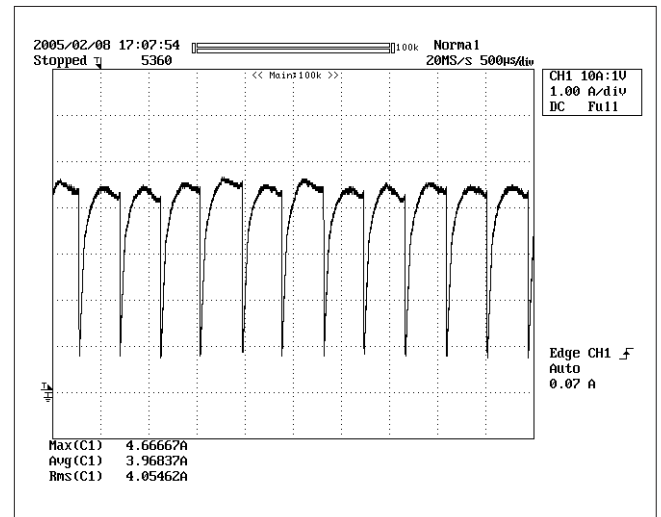

Fig. 6 Current waveform (San Ace 120 SG type fan)



Fig. 7 Comparison of external appearance of newly developed fan (left) and conventional fan (right)

system was adopted. This system enabled current waveform ripple to be reduced and allowed the heat emitted by the semiconductor element in the drive circuit to be dispersed.

Moreover, an aluminum die-cast frame was used to enable the heat from the motor to be efficiently discharged.

The use of these systems enabled the coil temperature rise to be held to 12 K despite the power consumption of 48 W.

A new frame shape and blade were designed, without sticking rigidly to the conventional design. Fig. 7 shows a comparison of the conventional fan with the newly developed fan. To accommodate the increase in air flow, the number of

blades was changed from 7 blades in the conventional fan to 9 blades in the new fan. The number of frame spokes was also increased from 3 in the conventional fan to 4 in the new fan to increase structural strength, in consideration of the vibration during operation of the high output motor.

## 5.2 Comparison of air flow - static pressure features

Fig. 8 shows a sample comparison of the air flow and static pressure features of the newly developed fan as compared to the conventional fan with the highest speed. Compared to the highest speed conventional fan, the maximum air flow of the new fan is approximately 40% greater, while its maximum static pressure is approximately 50% greater, representing the highest performance in its class in the industry (as of March 2005). In addition, Fig. 9 shows a sample comparison of the air flow and static pressure features of the newly developed fan and the conventional fan that is one size larger (140mm sq. × 51mm thick). The maximum air flow is lower, but in the actual use range of system impedance  $P = 1.95 Q^2$  or greater, the newly developed fan offers superior performance.

## 6. Speed control functions

Recently there has been a demand for higher air flow in fans of all sizes. However, as increased air flow also increases power consumption and noise, these fans are rarely used continuously at full speed. Increasingly, a temperature sensor or the like is used to provide variable speed control, or multiple fans are used for redundant run. For this reason, the newly developed San Ace 120 SG type fan has been provided from the outset with two types of speed control function: PWM speed control and static pressure instruction speed control. Fig. 10 shows the features of the PWM speed control function.

## 7. Conclusion

This report has presented some of the functions and performance attributes of the newly developed San Ace 120 SG type fan. In the future, information and telecommunications equipment will continue to offer improved performance and denser, more compact design, resulting in increased heat generation. As a result, even more compact cooling fans with high air flow will be needed. For this reason, we expect the newly developed San Ace 120 SG type fan to find application in a wide range of fields.

Through the incorporation of many new technical

innovations, this development effort succeeded in increasing the air flow of the 120mm sq. × 38mm thick fan. In the future, when increasing the air flow for fans of other sizes, it is thought that the same techniques will need to be implemented.

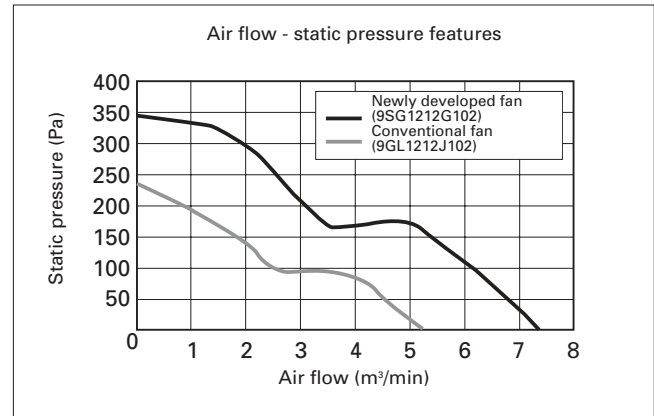

Fig. 8 Sample comparison of air flow and static pressure features

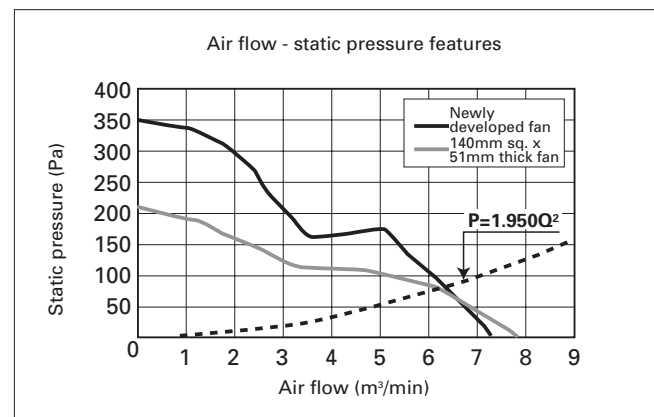

Fig. 9 Sample comparison of air flow and static pressure features

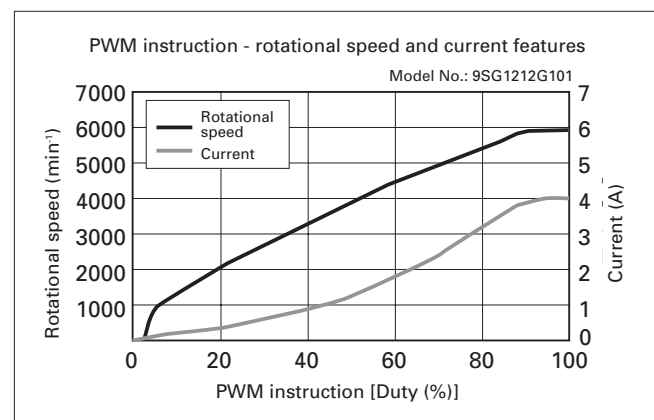

Fig. 10 Sample PWM instruction - rotational speed and current features



**Satoshi Fujimaki**

Joined Sanyo Denki in 1982  
Cooling Systems Division, Design Dept.  
Worked on fan motor development and design



**Jirou Watanabe**

Joined Sanyo Denki in 1978  
Cooling Systems Division, Design Dept.  
Worked on fan motor development and design



**Toshiyuki Nakamura**

Joined Sanyo Denki in 1999  
Cooling Systems Division, Design Dept.  
Worked on fan motor development and design



**Yasuhiro Maruyama**

Joined Sanyo Denki in 2001  
Cooling Systems Division, Design Dept.  
Worked on fan motor development and design



**Tetsuya Yamazaki**

Joined Sanyo Denki in 1997  
Cooling Systems Division, Design Dept.  
Worked on fan motor development and design