

**SERIES:** AE10-UW | **DESCRIPTION:** DC-DC CONVERTER**FEATURES**

- 10 watts
- high operating temp -40 to +70°C
- 4,000 Vac isolation
- designed to meet UL 1741; EN 62109 approved
- board mounted
- input voltage range of 200~1,500 Vdc
- low ripple & noise
- OVP protection
- output short circuit protection

**MODEL**

	input voltage range (Vdc)	output voltage (Vdc)	output current		output power max (W)	ripple & noise <sup>1</sup> max (mVp-p)	efficiency <sup>2</sup> typ (%)
			min (A)	max (A)			
AE10-UW-S5	200~1500	5	0	2.0	10	300	64

Notes:

1. Measured at nominal input, 20 MHz bandwidth oscilloscope, with 10  $\mu$ F electrolytic and 1  $\mu$ F ceramic capacitors on the output.
2. Measured at 800 Vdc input voltage, full load.
3. All specifications are measured at  $T_a=25^\circ\text{C}$ , humidity < 75%, nominal input voltage, and rated output load unless otherwise specified.

**PART NUMBER KEY****AE10-UW - SXX**

Base Number

Output Voltage

## INPUT

parameter	conditions/description	min	typ	max	units
operating input voltage		200		1500	Vdc
under voltage shutdown	shut-down range	170		185	Vdc
	turn-on range	180		195	Vdc
current	at 200 Vdc			120	mA
	at 800 Vdc			30	mA
	at 1500 Vdc			16	mA
inrush current	at 200 Vdc		30		A
	at 800 Vdc		80		A
	at 1500 Vdc		150		A
input fuse	4 A / 1500 Vdc (external)				

## OUTPUT

parameter	conditions/description	min	typ	max	units
maximum capacitive load				6,000	μF
voltage accuracy			±2		%
line regulation	from low line to high line, full load		±1		%
load regulation	from 0% to full load		±1		%
delay time	from Vin = 0 V to 90% of rated output voltage			2	s
switching frequency			65		kHz
temperature coefficient	at full load		±0.02		%/°C

## PROTECTIONS

parameter	conditions/description	min	typ	max	units
over voltage protection				8	Vdc
over current protection	automatic recovery	120		320	%
short circuit protection	continuous, automatic recovery				

## SAFETY AND COMPLIANCE

parameter	conditions/description	min	typ	max	units
isolation voltage	input to output for 1 minute	4,000			Vac
safety approvals	CSA, EN 62109				
conducted emissions	CISPR22/EN55022, class A (external circuit required, see Figure 2)				
radiated emissions	CISPR22/EN55022, class A (external circuit required, see Figure 2)				
ESD	IEC/EN61000-4-2, contact ± 6kV/air ± 8kV, class B				
radiated immunity	IEC/EN61000-4-3, 10V/m, class A				
EFT/burst	IEC/EN61000-4-4, ± 2kV, class B (external circuit required, see Figure 2)				
surge	IEC/EN61000-4-5, line-line ± 1kV, class B (external circuit required, see Figure 2)				
conducted immunity	IEC/EN61000-4-6, 10 Vr.m.s, class A				
magnetic field immunity	IEC/EN61000-4-8, 10 A/m, class A				
MTBF	as per MIL-HDBK-217F, 25°C	300,000			hours
RoHS	yes				

**ENVIRONMENTAL**

parameter	conditions/description	min	typ	max	units
operating temperature	see derating curves	-40		70	°C
storage temperature		-40		85	°C
storage humidity	non-condensing			95	%
altitude	see derating curves			5000	m

**SOLDERABILITY**

parameter	conditions/description	min	typ	max	units
hand soldering	for 3~5 seconds	350	360	370	°C
wave soldering	for 5~10 seconds	255	260	265	°C

**MECHANICAL**

parameter	conditions/description	min	typ	max	units
dimensions	125.00 x 75.00 x 40.00 [4.921 x 2.953 x 1.575 inch]				mm
case material	black flame-retardant heat-proof plastic (UL94V-0)				
weight			300		g

**MECHANICAL DRAWING**

units: mm [inch]

tolerance:  $\pm 0.50$  [ $\pm 0.020$ ]pin diameter tolerance:  $\pm 0.10$  [ $\pm 0.004$ ]pin height tolerance:  $\pm 1.50$  [ $\pm 0.059$ ]

In high vibration environments, this series should be mounted with screws.  
tightening torque: max 0.4 N\*m

PIN CONNECTIONS	
PIN	Function
1	-Vin
2	+Vin
3	NC
4	-Vout
5	+Vout

NC=no connection

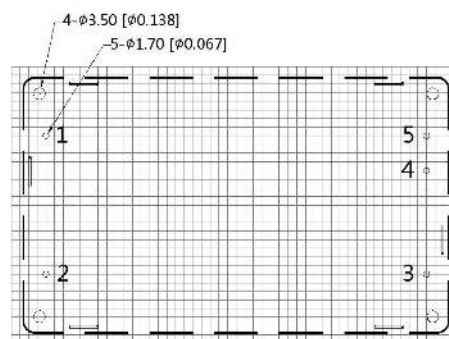
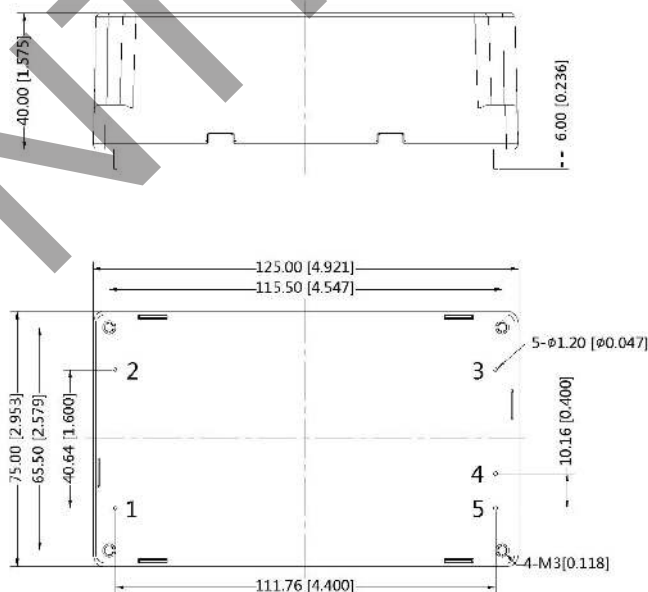

Note : Grid 2.54\*2.54mm

Recommended PCB Layout  
Top View

## DERATING CURVES

**TEMPERATURE DERATING CURVE  
(200~300 Vdc Input voltage)**

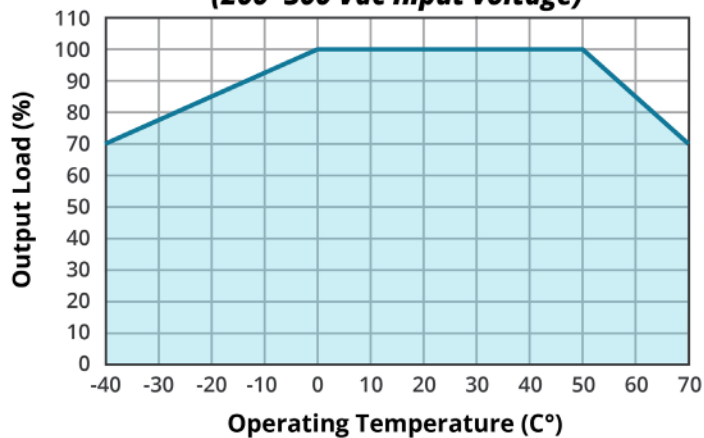

**TEMPERATURE DERATING CURVE  
(300~1000 Vdc Input voltage)**

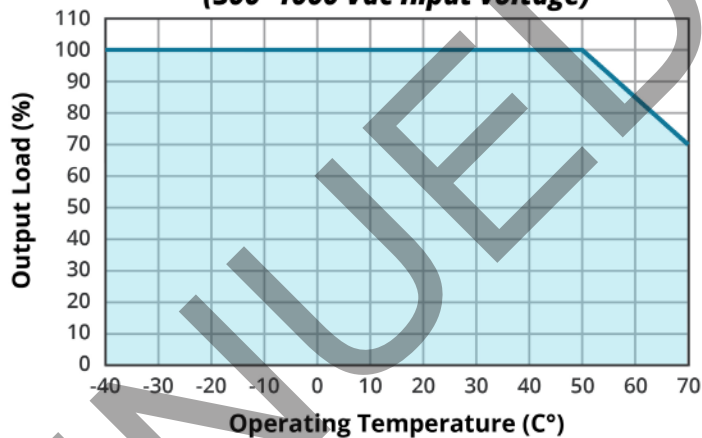

**INPUT VOLTAGE DERATING CURVE  
25°C**

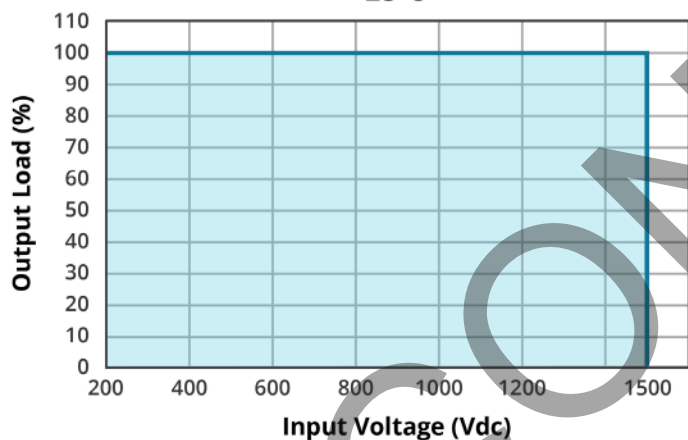

**ALTITUDE DERATING CURVE**

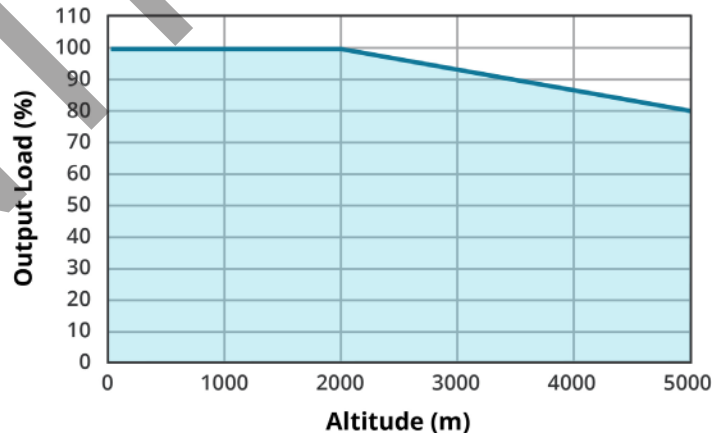

## EFFICIENCY CURVES

**EFFICIENCY VS INPUT VOLTAGE**

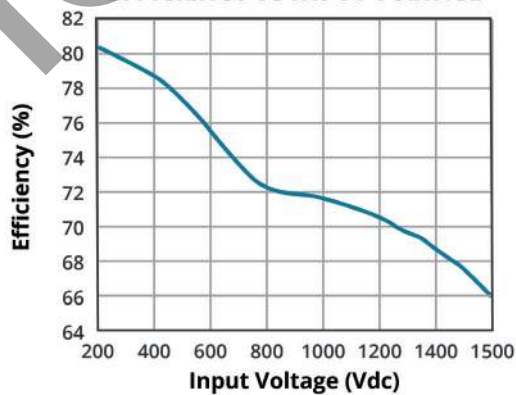

**EFFICIENCY VS OUTPUT LOAD**

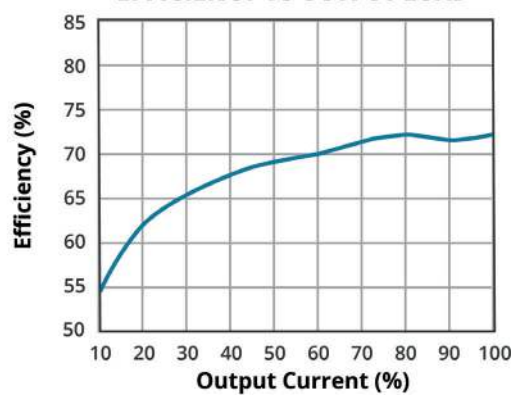

## APPLICATION CIRCUIT

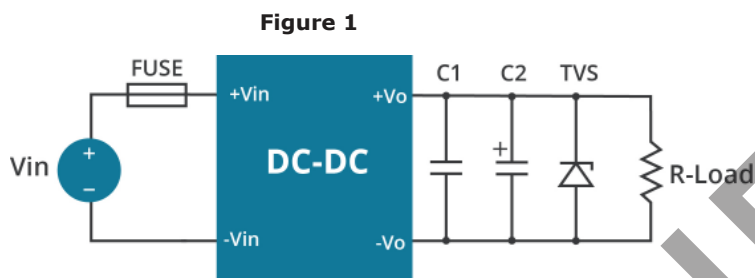

**Table 1**

Vout (Vdc)	Fuse	C1 ( $\mu$ F)	C2 ( $\mu$ F)	TVS
5	4 A / 1500 Vdc	1	120	SMBJ7.0A

## EMC RECOMMENDED CIRCUIT

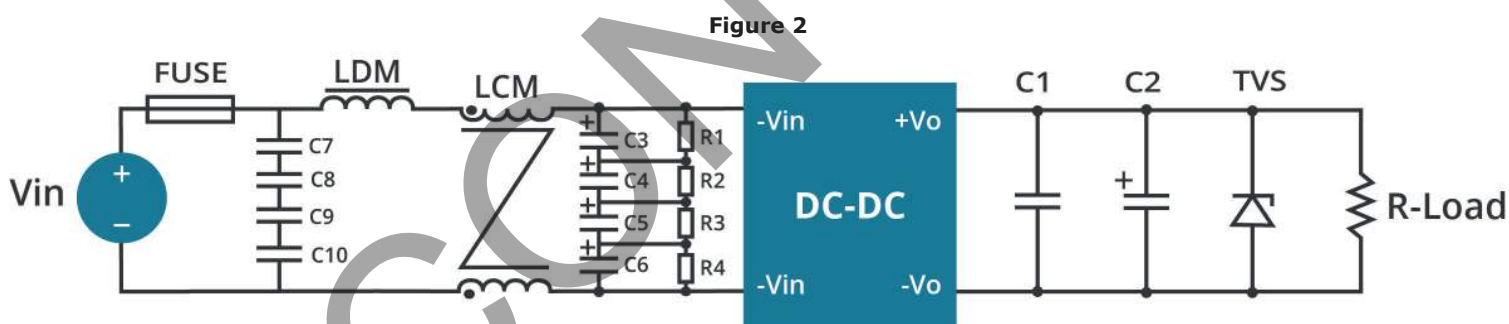

**Table 2**

Recommended External Circuit Components	
FUSE	4 A/1500 Vdc
C7, C8, C9, C10	104K/275 Vac
C3, C4, C5, C6	47 $\mu$ F/450 Vdc
R1, R2, R3, R4	1 M $\Omega$ /2 W
LDM	330 $\mu$ H/1 A
LCM	7 mH/1 A

Note: See also Table 1.

Notes:

1. C1 is a ceramic capacitor used to filter high frequency noise.
2. C2 is electrolytic and is recommended to be high frequency and low resistance. For capacitance and current of the capacitor, refer to the datasheet provided by the manufacturer. Capacitance withstand voltage derating should be 80% or above.

## REVISION HISTORY

rev.	description	date
1.0	initial release	09/13/2017
1.01	updated datasheet	03/05/2018
1.02	changed external input fuse recommendation	07/24/2019
1.03	company logo updated	04/12/2021
1.04	derating curve, efficiency curves and circuit figures updated	07/27/2021

The revision history provided is for informational purposes only and is believed to be accurate.



**CUI INC**

a bel group

**Headquarters**  
20050 SW 112th Ave.  
Tualatin, OR 97062  
**800.275.4899**

Fax 503.612.2383  
**cui.com**  
techsupport@cui.com

CUI offers a two (2) year limited warranty. Complete warranty information is listed on our website.

CUI reserves the right to make changes to the product at any time without notice. Information provided by CUI is believed to be accurate and reliable. However, no responsibility is assumed by CUI for its use, nor for any infringements of patents or other rights of third parties which may result from its use.

CUI products are not authorized or warranted for use as critical components in equipment that requires an extremely high level of reliability. A critical component is any component of a life support device or system whose failure to perform can be reasonably expected to cause the failure of the life support device or system, or to affect its safety or effectiveness.