

# 500mA Low Dropout Positive Voltage Regulator

## General Description

The RT9163 is a positive low dropout regulator designed for applications requiring low dropout performance at full rated current. The device is available in fixed output voltage of 3.3V, 3.5V, and 5.0V. The RT9163 provides excellent regulation over line, load, and temperature variations.

The other features include low dropout performance at a maximum of 1.4V at 500mA, fast transient response, internal current limiting, and thermal shutdown protection of the output devices. The RT9163 is a three-terminal regulator available in surface mount SOT-89, SOT-223, and TO-252 packages.

## Ordering Information

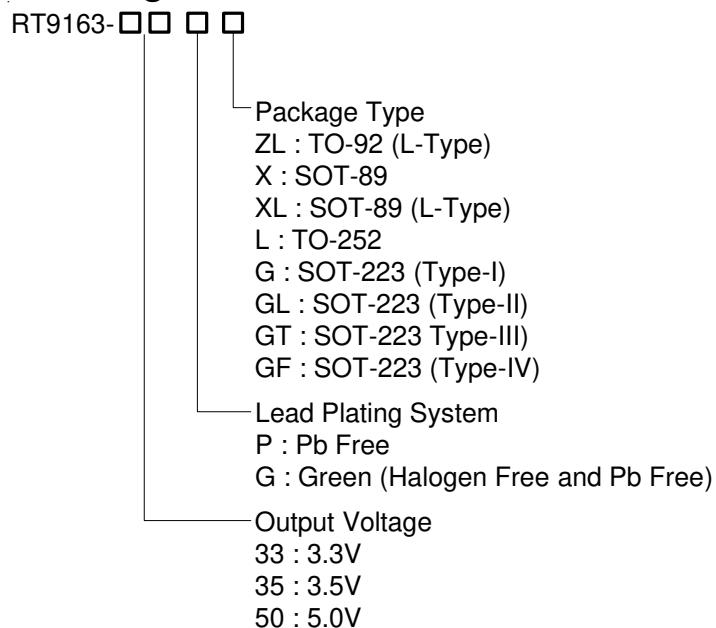

Note :

Richtek products are :

- ▶ RoHS compliant and compatible with the current requirements of IPC/JEDEC J-STD-020.
- ▶ Suitable for use in SnPb or Pb-free soldering processes.

## Marking Information

For marking information, contact our sales representative directly or through a Richtek distributor located in your area.

## Features

- Low Dropout, Maximum 1.4V at 500mA
- Fast Transient Response
- ±2% Total Output Regulation
- 0.4% Line Regulation
- 0.4% Load Regulation
- TO-92, SOT-89, SOT-223, and TO-252 Packages
- RoHS Compliant and 100% Lead (Pb)-Free

## Applications

- 5V to 3.3V Linear Regulator
- Low Voltage Microcontroller, DSP,.... etc. Power Supply
- Linear Regulator for LAN Card and CD-ROM

## Pin Configurations

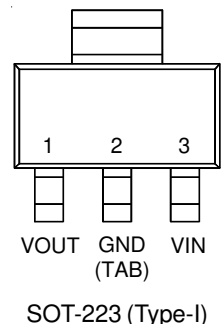
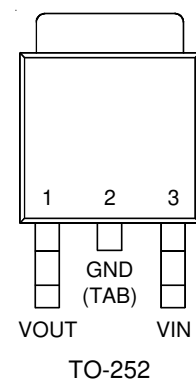
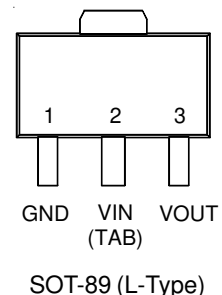
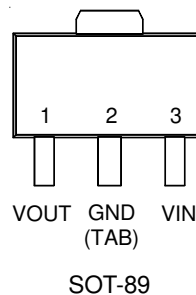
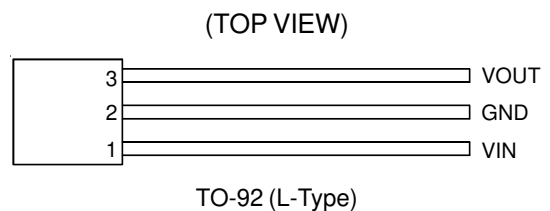

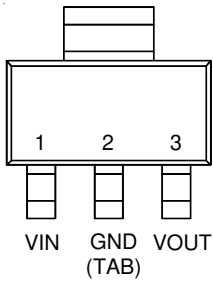

SOT-223 (Type-II)

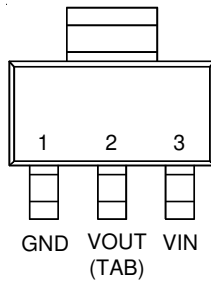

SOT-223 (Type-III)

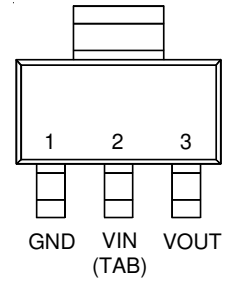

SOT-223 (Type-IV)

Typical Application Circuit

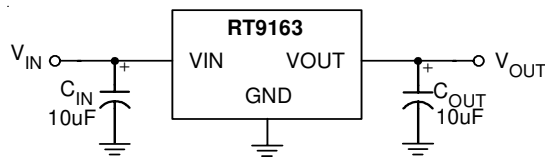

Function Block Diagram

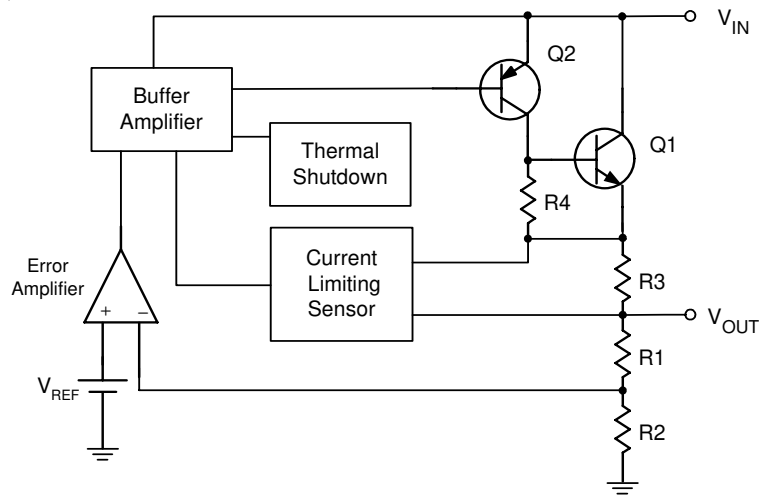

Functional Pin Description

Pin Name	Pin Function
VOUT	Output Voltage.
GND	Ground.
VIN	Power Input.

**Absolute Maximum Ratings**

- Input Voltage ----- 15V
- Power Dissipation,  $P_D$  @  $T_A = 25^\circ\text{C}$ 
  - TO-92 ----- 0.625W
  - SOT-89 ----- 0.571W
  - SOT-223 ----- 0.740W
  - TO-252 ----- 1.471W
- Package Thermal Resistance (Note 1)
  - TO-92,  $\theta_{JA}$  ----- 160°C/W
  - SOT-89,  $\theta_{JC}$  ----- 48°C/W
  - SOT-89,  $\theta_{JA}$  ----- 175°C/W
  - SOT-223,  $\theta_{JC}$  ----- 19°C/W
  - SOT-223,  $\theta_{JA}$  ----- 135°C/W
  - TO-252,  $\theta_{JC}$  ----- 7.5°C/W
  - TO-252,  $\theta_{JA}$  ----- 68°C/W
- Operating Junction Temperature Range ----- -40°C to 125°C
- Storage Temperature Range ----- -65°C to 150°C

**Electrical Characteristics**

( $V_{IN} = 5\text{V}$ ,  $T_A = 25^\circ\text{C}$ , unless otherwise specified)

Parameter		Symbol	Test Conditions	Min	Typ	Max	Unit
Output Voltage (Note 2)	RT9163-33	$V_{OUT}$		3.235	3.300	3.365	V
	RT9163-35			3.430	3.500	3.570	
	RT9163-50		$V_{IN} = 7\text{V}$	4.900	5.000	5.100	
Line Regulation (Note 2)	RT9163-33	$\Delta V_{LINE}$	$V_{IN} = 5\text{V to }15\text{V}$	--	0.1	0.4	%
	RT9163-35						
	RT9163-50		$V_{IN} = 7\text{V to }15\text{V}$	--	0.1	0.4	
Load Regulation (Note 2)		$\Delta V_{LOAD}$	$I_L = 0 \text{ to } 500\text{mA}$	--	0.2	0.4	%
Dropout Voltage (Note 3)		$V_{DROP}$	$\Delta V_{OUT} = 1\%$	--	1.3	1.4	V
Current Limit		$I_{LIM}$	Load = 1Ω	550	--	--	mA
Quiescent Current		$I_Q$		--	4.5	8	mA
Temperature Coefficient		$T_C$		--	0.005	--	%/°C
Temperature Stability		$T_S$		--	0.5	--	%
RMS Output Noise (Note 4)				--	0.003	--	%/ $V_{OUT}$

**Note 1.**  $\theta_{JA}$  is measured in the natural convection at  $T_A = 25^\circ\text{C}$  on a low effective thermal conductivity test board of JEDEC 51-3 thermal measurement standard. The case point of  $\theta_{JC}$  is on the center of the exposed pad.

**Note 2.** Low duty cycle pulse tested with Kelvin connections.

**Note 3.** The dropout voltage is defined as  $V_{IN} - V_{OUT}$ , which is measured when  $V_{OUT}$  is  $V_{OUT(NORMAL)} - 100\text{mV}$ .

**Note 4.** Bandwidth of 10 Hz to 10 kHz.

## Outline Dimension

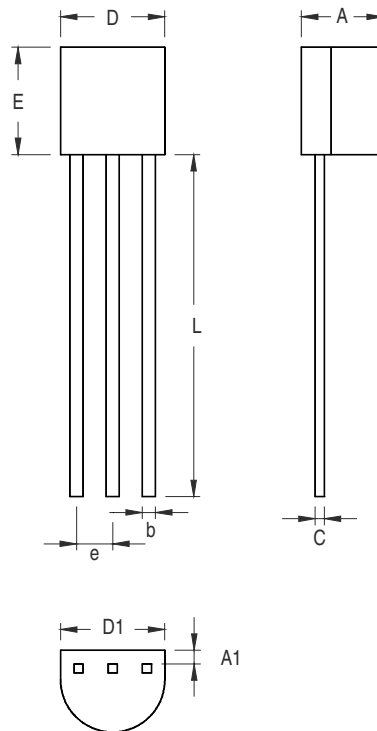

Symbol	Dimensions In Millimeters		Dimensions In Inches	
	Min	Max	Min	Max
A	3.175	4.191	0.125	0.165
A1	1.143	1.372	0.045	0.054
b	0.406	0.533	0.016	0.021
C	0.406	0.533	0.016	0.021
D	4.445	5.207	0.175	0.205
D1	3.429	5.029	0.135	0.198
E	4.318	5.334	0.170	0.210
e	1.143	1.397	0.045	0.055
L	12.700		0.500	

**3-Lead TO-92 Plastic Package**

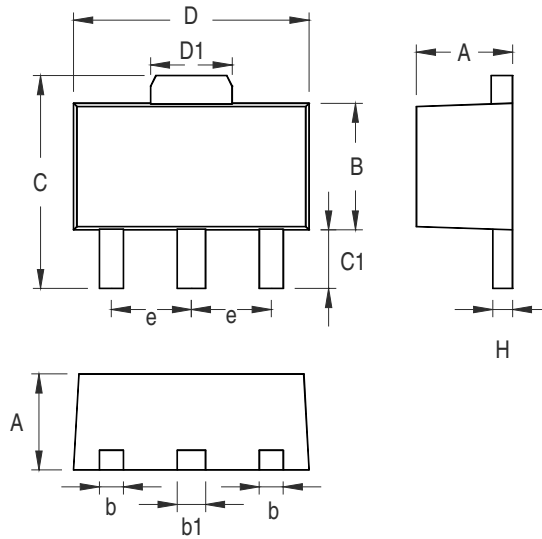

Symbol	Dimensions In Millimeters		Dimensions In Inches	
	Min	Max	Min	Max
A	1.397	1.600	0.055	0.063
b	0.356	0.483	0.014	0.019
B	2.388	2.591	0.094	0.102
b1	0.406	0.533	0.016	0.021
C	3.937	4.242	0.155	0.167
C1	0.787	1.194	0.031	0.047
D	4.394	4.597	0.173	0.181
D1	1.397	1.753	0.055	0.069
e	1.448	1.549	0.057	0.061
H	0.356	0.432	0.014	0.017

**3-Lead SOT-89 Surface Mount Package**

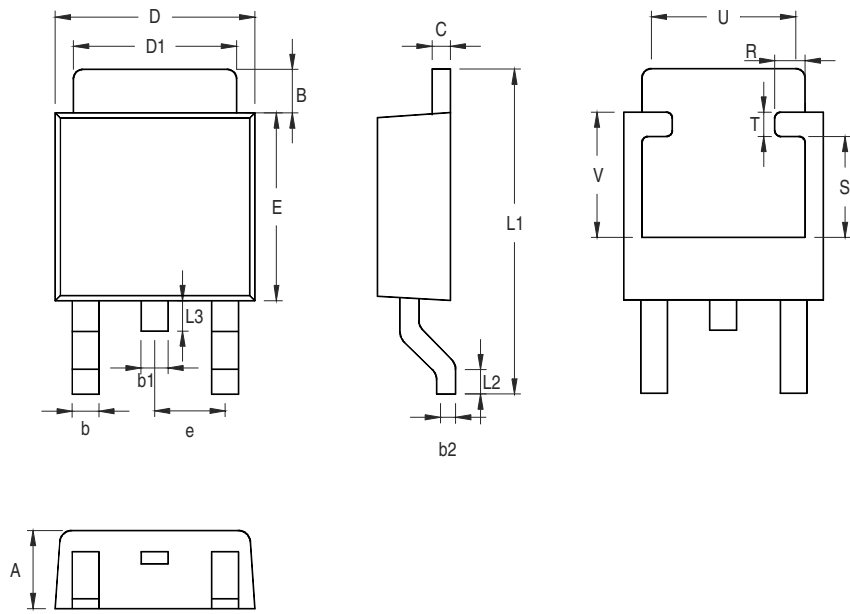

Symbol	Dimensions In Millimeters		Dimensions In Inches	
	Min	Max	Min	Max
A	2.184	2.388	0.086	0.094
B	0.889	2.032	0.035	0.080
b	0.508	0.889	0.020	0.035
b1	1.016 Ref.		0.040 Ref.	
b2	0.457	0.584	0.018	0.023
C	0.457	0.584	0.018	0.023
D	6.350	6.731	0.250	0.265
D1	5.207	5.461	0.205	0.215
E	5.334	6.223	0.210	0.245
e	2.108	2.438	0.083	0.096
L1	9.398	10.414	0.370	0.410
L2	0.508 Ref.		0.020 Ref.	
L3	0.635	1.016	0.025	0.040
U	3.810 Ref.		0.150 Ref.	
V	3.048 Ref.		0.120 Ref.	
R	0.200	0.850	0.008	0.033
S	2.500	3.400	0.098	0.134
T	0.500	0.850	0.020	0.033

3-Lead TO-252 Surface Mount Package

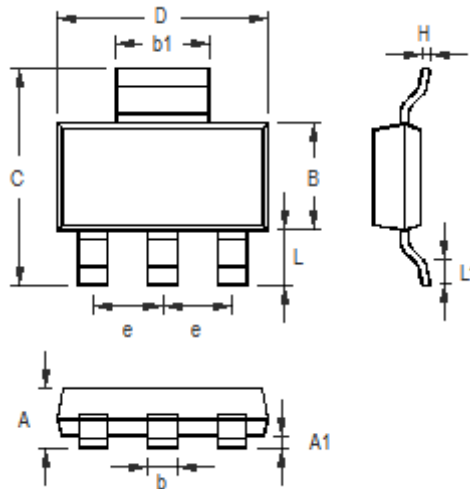

Symbol	Dimensions In Millimeters		Dimensions In Inches	
	Min	Max	Min	Max
A	1.400	1.800	0.055	0.071
A1	0.020	0.100	0.001	0.004
b	0.600	0.840	0.024	0.033
B	3.300	3.700	0.130	0.146
C	6.700	7.300	0.264	0.287
D	6.300	6.700	0.248	0.264
b1	2.900	3.100	0.114	0.122
e	2.300		0.091	
H	0.230	0.350	0.009	0.014
L	1.500	2.000	0.059	0.079
L1	0.800	1.100	0.031	0.043

**3-Lead SOT-223 Surface Mount Package**

**Richtek Technology Corporation**

Headquarter  
 5F, No. 20, Taiyuen Street, Chupei City  
 Hsinchu, Taiwan, R.O.C.  
 Tel: (8863)5526789 Fax: (8863)5526611

**Richtek Technology Corporation**

Taipei Office (Marketing)  
 5F, No. 95, Minchiuan Road, Hsintien City  
 Taipei County, Taiwan, R.O.C.  
 Tel: (8862)86672399 Fax: (8862)86672377  
 Email: marketing@richtek.com

Information that is provided by Richtek Technology Corporation is believed to be accurate and reliable. Richtek reserves the right to make any change in circuit design, specification or other related things if necessary without notice at any time. No third party intellectual property infringement of the applications should be guaranteed by users when integrating Richtek products into any application. No legal responsibility for any said applications is assumed by Richtek.