

### 4 PIN SOP ZERO-CROSS TRIAC PHOTOCOUPLER ELM304X, ELM306X, ELM308X Series



#### Features:

- Peak breakdown voltage
  - 400V: ELM304X
  - 600V: ELM306X
  - 800V: ELM308X
- High isolation voltage between input and output (Viso=3750 V rms)
- Zero voltage crossing
- Pb free and RoHS compliant.
- UL approved (No. E214129)
- VDE approved (No.132249)
- SEMKO approved
- NEMKO approved
- DEMKO approved
- FIMKO approved

#### Description

The ELM304X, ELM306X and ELM308X devices consist of a GaAs infrared emitting diode optically coupled to a monolithic silicon detector performing the function of a zero voltage crossing bilateral triac driver.

They are designed for use with a discrete power triac in the interface of logic systems to equipment powered from 110 to 240 VAC lines, such as solid-state relays, industrial controls, motors, solenoids and consumer appliances, etc.

#### Applications

- Solenoid/valve controls
- Light controls
- Static power switch
- AC motor drivers
- E.M. contactors
- Temperature controls
- AC Motor starters
- Solid state relays

Schematic

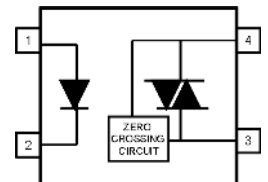

Pin Configuration

1. Anode
2. Cathode
3. Terminal
4. Terminal

**Absolute Maximum Ratings (Ta=25°C)**

Parameter		Symbol	Rating	Unit
Input	Forward current	$I_F$	60	mA
	Peak forward current (1us pulse, 300pps)	$I_{F(PK)}$	1	A
	Reverse voltage	$V_R$	6	V
	Power Dissipation	$P_D$	100	mW
Output			ELM304X	400
	Off-state Output Terminal Voltage	$V_{DRM}$	ELM306X	600
			ELM308X	800
	On state RMS current	$I_{T(RMS)}$	70	mA(RMS)
Power dissipation	$P_C$	300	mW	
Isolation voltage <sup>*1</sup>		$V_{ISO}$	3750	Vrms
Operating temperature		$T_{OPR}$	-40~+110	°C
Storage temperature		$T_{STG}$	-55~+150	°C
Soldering Temperature <sup>*2</sup>		$T_{SOL}$	260	°C

Notes:

\*1 AC for 1 minute, R.H.= 40 ~ 60% R.H. In this test, pins 1, 2 are shorted together, and pins 3, 4 are shorted together.

\*2 For 10 seconds

**Electro-Optical Characteristics (Ta=25°C unless specified otherwise)**

**Input**

Parameter	Symbol	Min.	Typ.*	Max.	Unit	Condition
Forward Voltage	$V_F$	-	-	1.5	V	$I_F = 30\text{mA}$
Reverse Leakage current	$I_R$	-	-	10	$\mu\text{A}$	$V_R = 6\text{V}$

**Output**

Parameter	Symbol	Min.	Typ.*	Max.	Unit	Condition
Peak Blocking Current	$I_{\text{DRM1}}$	-	-	100	nA	$V_{\text{DRM}} = \text{Rated } V_{\text{DRM}}$ $I_F = 0\text{mA}$
Peak On-state Voltage	$V_{\text{TM}}$	-	-	3	V	$I_{\text{TM}} = 100\text{mA peak}$
Critical Rate of Rise off-state Voltage	$dv/dt$	1000	-	-	V/ $\mu\text{s}$	
Inhibit Voltage (MT1-MT2 voltage above which device will not trigger)	$V_{\text{INH}}$	-	-	20	V	$I_F = \text{Rated } I_{\text{FT}}$
Leakage in Inhibited State	$I_{\text{DRM2}}$	-	-	1000	$\mu\text{A}$	$I_F = \text{Rated } I_{\text{FT}}$ , $V_{\text{DRM}} = \text{Rated } V_{\text{DRM}}$ , off state

**Transfer Characteristics**

Parameter	Symbol	Min.	Typ.*	Max.	Unit	Condition	
LED Trigger Current	$I_{\text{FT}}$	3042	-	-	10	mA	Main terminal Voltage=3V
		3062	-	-	10		
		3082	-	-	10		
		3043	-	-	5		
		3063	-	-	5		
		3083	-	-	5		
Holding Current	$I_H$	3044	-	-	3	$\mu\text{A}$	
		3064	-	-	3		
		3084	-	-	3		
			-	280	-		

\* Typical values at  $T_a = 25^\circ\text{C}$

Typical Electro-Optical Characteristics Curves

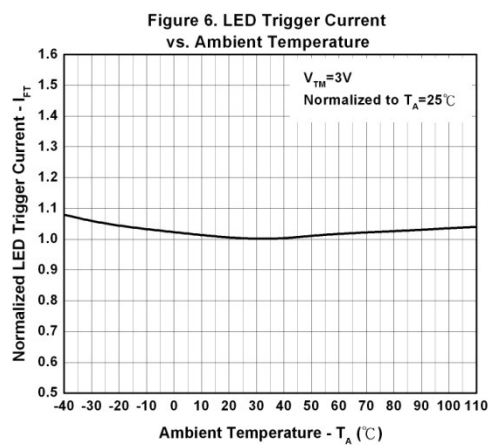
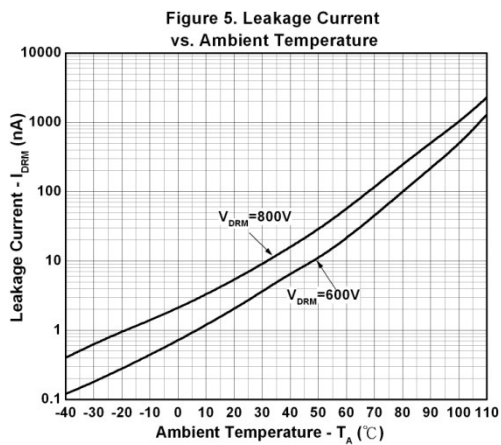
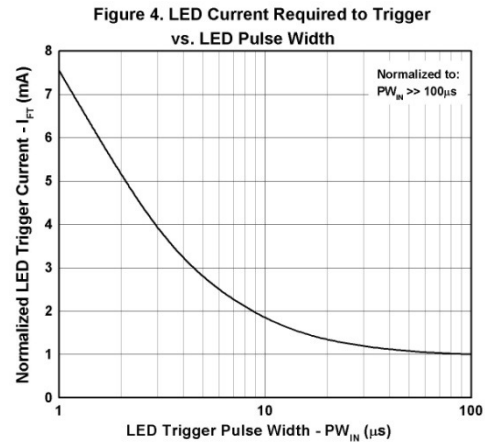
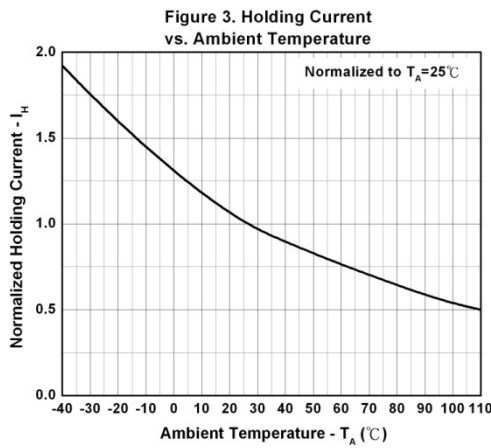
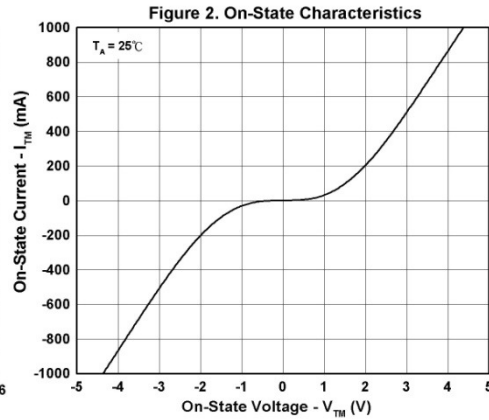
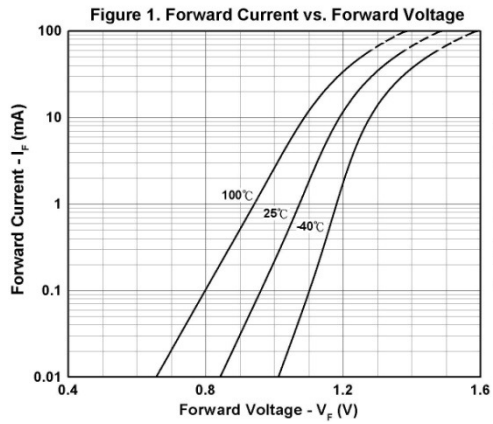

Figure 7. Off-State Output Terminal Voltage vs. Ambient Temperature

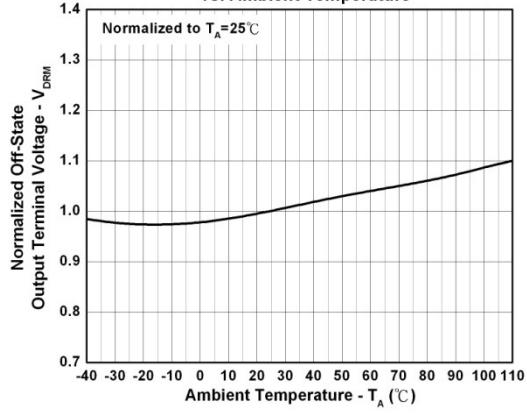

Figure 8. Leakage in Inhibit State vs. Ambient Temperature

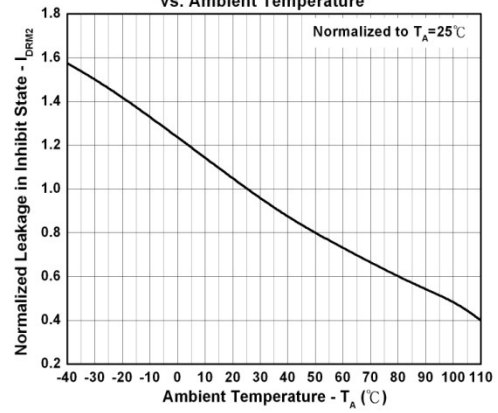

Figure 9. Inhibit Voltage vs. Ambient Temperature

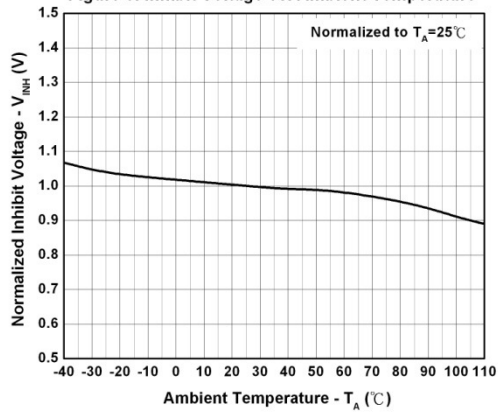
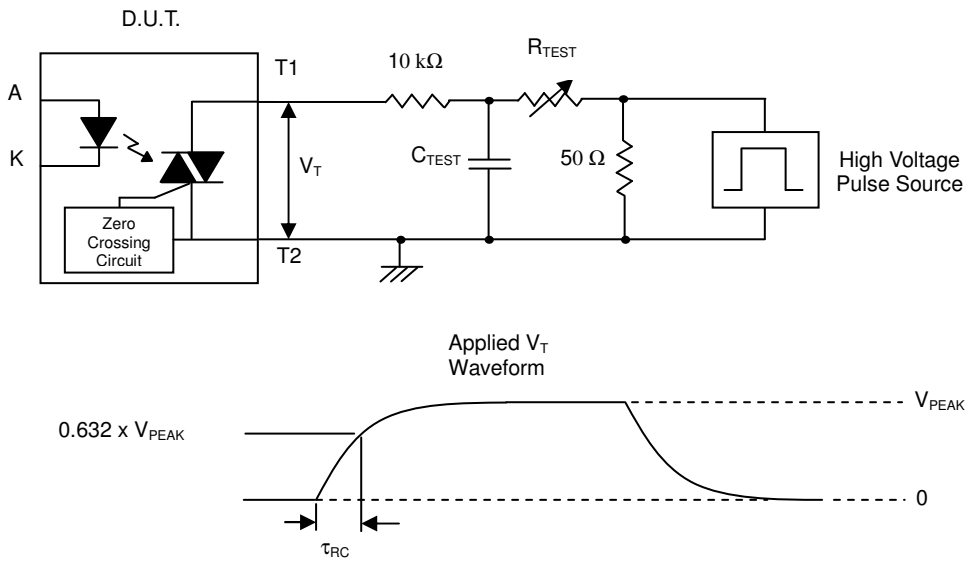

Figure 10. Static dv/dt Test Circuit & Waveform



### Measurement Method

The high voltage pulse is set to the required  $V_{PEAK}$  value and applied to the D.U.T. output side through the RC circuit above. LED current is not applied. The waveform  $V_T$  is monitored using a x100 scope probe. By varying  $R_{TEST}$ , the  $dv/dt$  (slope) is increased, until the D.U.T. is observed to trigger (waveform collapses). The  $dv/dt$  is then decreased until the D.U.T. stops triggering. At this point,  $\tau_{RC}$  is recorded and the  $dv/dt$  calculated.

$$dv/dt = \frac{0.632 \times V_{PEAK}}{\tau_{RC}}$$

$$dv/dt = \frac{0.632 \times V_{PEAK}}{\tau_{RC}}$$

For example,  $V_{PEAK} = 600V$  for EL306X series. The  $dv/dt$  value is calculated as follows:

$$dv/dt = \frac{0.63 \times 600}{\tau_{RC}} = \frac{378}{\tau_{RC}}$$

## Order Information

### Part Number

**ELM304X(Z)-V**  
or **ELM306X(Z)-V**  
or **ELM308X(Z)-V**

### Note

X = Part No. (2 for  $I_{FT}=10mA$ , 3 for  $I_{FT}=5mA$ , 4 for  $I_{FT}=3mA$ )  
Z = Tape and reel option (TA, TB or none).  
V = VDE safety approved optional

Option	Description	Packing quantity
None	Standard	100 units per tube
None	Standard + VDE safety optional	100 units per tube
(TA)	TA tape & reel option	3000 units per reel
(TB)	TB tape & reel option	3000 units per reel
(TA)-V	TA tape & reel option + VDE safety optional	3000 units per reel
(TB)-V	TB tape & reel option + VDE safety optional	3000 units per reel

**Package Dimension (Dimensions in mm)**

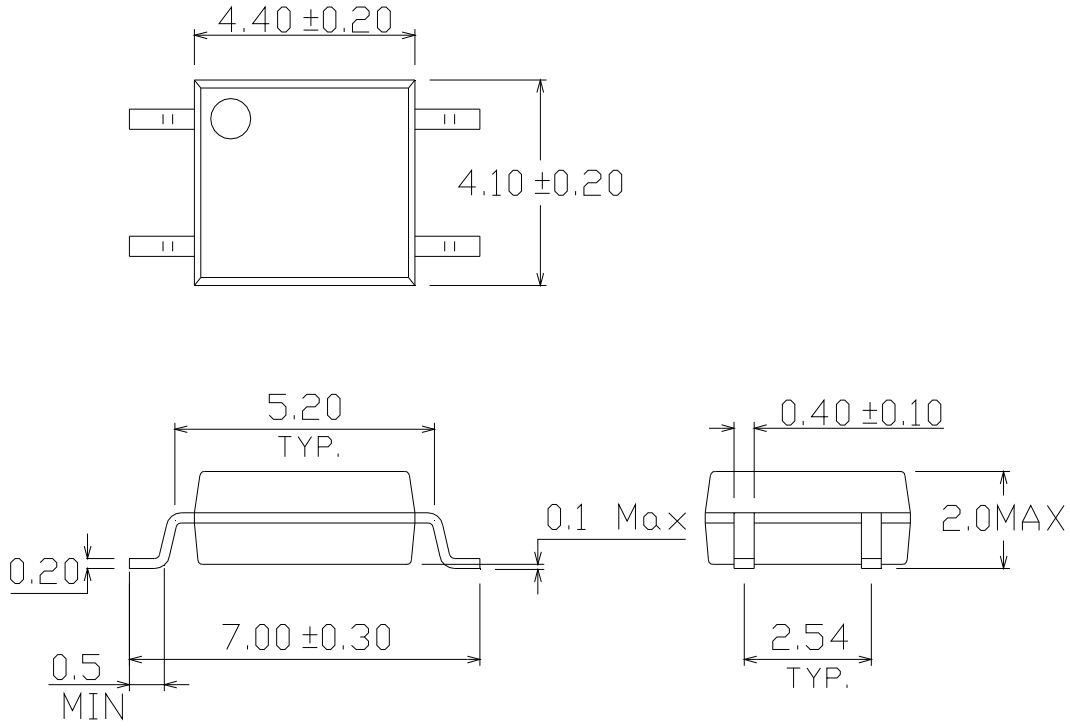

**Recommended pad layout for surface mount leadform**

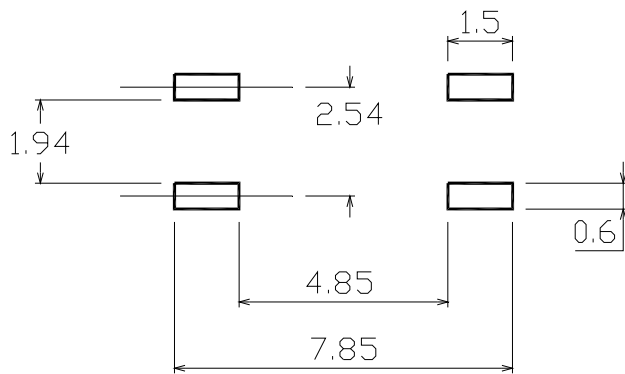



## Device Marking



## Notes

EL	denotes Everlight
M3063	denotes Device Number
Y	denotes 1 digit Year code
WW	denotes 2 digit Week code
V	denotes VDE safety option (optional)

**Tape & Reel Packing Specifications**

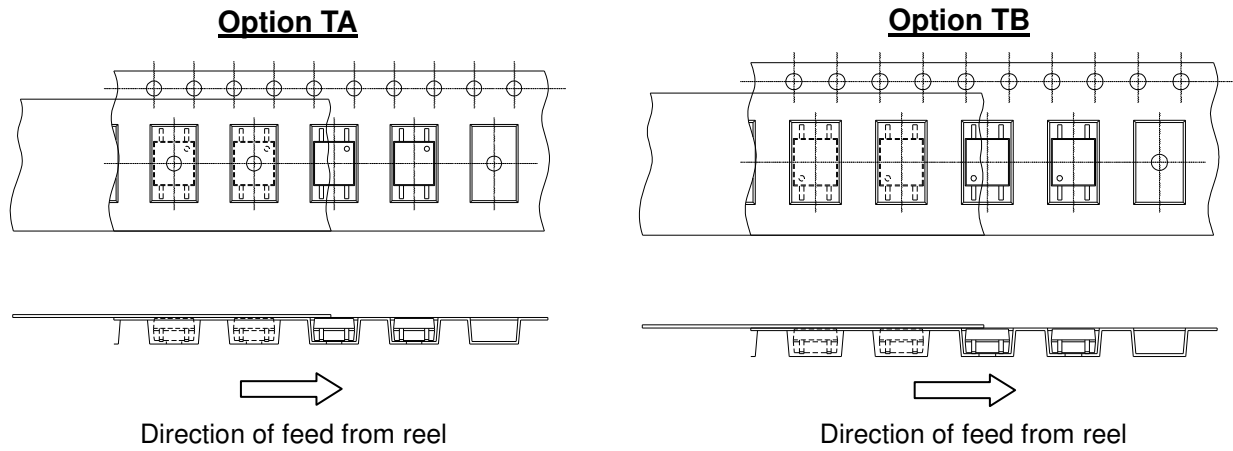

**Tape dimensions**

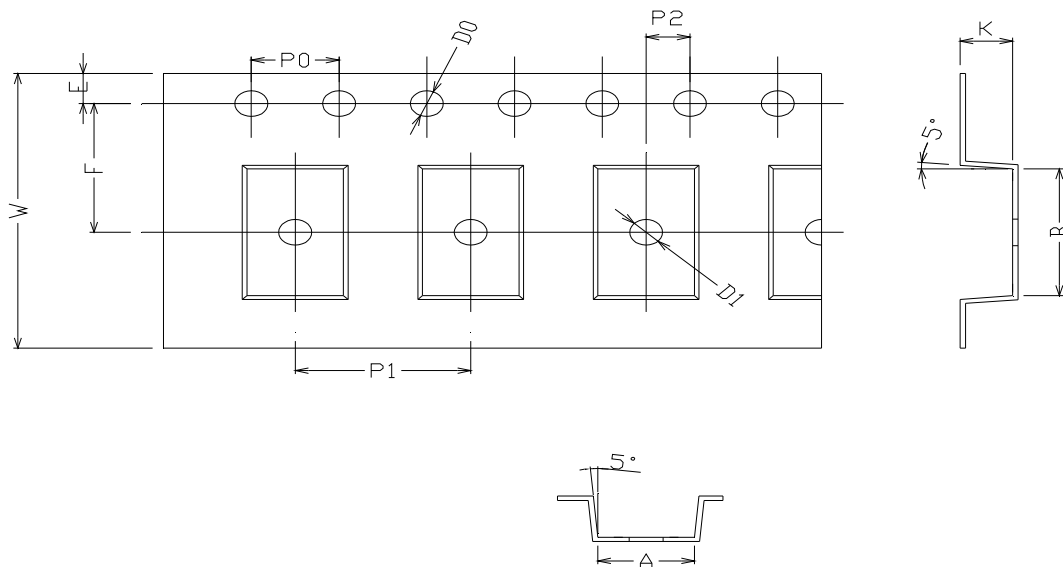

Dimension No.	A	B	Do	D1	E	F
Dimension (mm)	4.4 ± 0.1	7.4 ± 0.1	1.5 + 0.1/-0	1.5 ± 0.1	1.75 ± 0.1	7.5 ± 0.1

Dimension No.	Po	P1	P2	t	W	K
Dimension (mm)	4.0 ± 0.15	8.0 ± 0.1	2.0 ± 0.1	0.25 ± 0.03	16.0 ± 0.2	2.4 ± 0.1

## Precautions for Use

### 1. Soldering Condition

#### 1.1 (A) Maximum Body Case Temperature Profile for evaluation of Reflow Profile

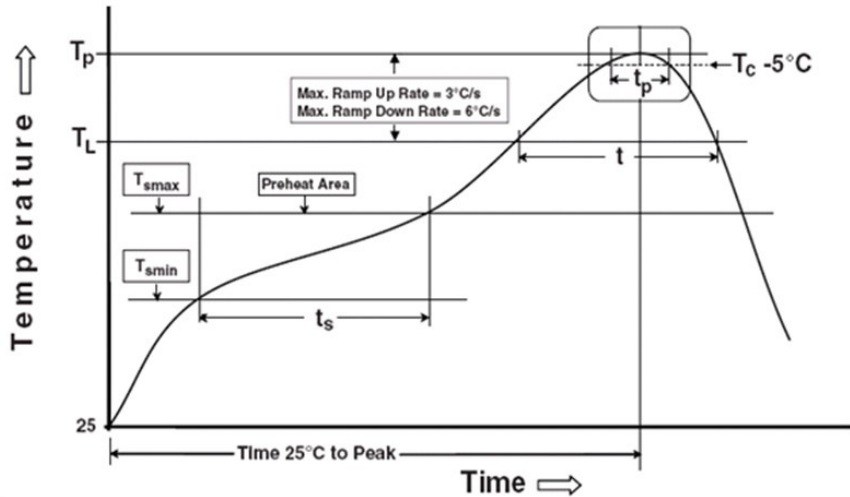

Note:

Reference: IPC/JEDEC J-STD-020D

#### Preheat

Temperature min ( $T_{smin}$ )	150 °C
Temperature max ( $T_{smax}$ )	200 °C
Time ( $T_{smin}$ to $T_{smax}$ ) ( $t_s$ )	60-120 seconds
Average ramp-up rate ( $T_{smax}$ to $T_p$ )	3 °C/second max

#### Other

Liquidus Temperature ( $T_L$ )	217 °C
Time above Liquidus Temperature ( $t_L$ )	60-100 sec
Peak Temperature ( $T_p$ )	260 °C
Time within 5 °C of Actual Peak Temperature: $T_p - 5^\circ\text{C}$	30 s
Ramp- Down Rate from Peak Temperature	6 °C /second max.
Time 25 °C to peak temperature	8 minutes max.
Reflow times	3 times

## **DISCLAIMER**

1. Above specification may be changed without notice. EVERLIGHT will reserve authority on material change for above specification.
2. When using this product, please observe the absolute maximum ratings and the instructions for using outlined in these specification sheets. EVERLIGHT assumes no responsibility for any damage resulting from use of the product which does not comply with the absolute maximum ratings and the instructions included in these specification sheets.
3. These specification sheets include materials protected under copyright of EVERLIGHT corporation. Please don't reproduce or cause anyone to reproduce them without EVERLIGHT's consent.