

PS2P-ARC

Play Resistant Arc Position Sensor



Available with
CAN

KEY FEATURES

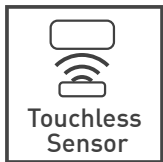

Touchless
Sensor

True touchless operation

Without any internal or external gears or linkages the sensor is easily assembled and calibrated and free from wear and tear over lifetime.



Play
resistant

Immune to radial and axial play

Maintains stable electrical output and specified linearity despite radial and axial tolerances avoiding performance loss and maintenance cost.



IP67
IP69K

Made for harsh environments

IP69K sealing, high operating temperature range as well as shock and vibration resistance allow the use in the most demanding environments.

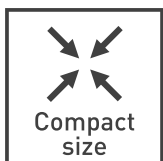

Compact
size

Compact and low profile package

Without the need for a shaft the sensor is provided in an exceptionally compact and low profile package that fits in space constrained applications.



Virtually
unlimited life

Unlimited mechanical life

The separation of electronics and magnet module allows for a virtually unlimited lifetime independent of number of revolutions.



Fully
customizable

Adaptable to your requirements

Custom mechanical design, programmable transfer function and switch outputs as well as different output protocols and redundancy levels available.

DESCRIPTION

Piher Sensing Systems' PS2P-ARC position sensor creates immunity to radial and axial play on pivot joints where misalignment results in poor operational performance and labor intensive maintenance programs.

The magnet is attached to the rotating parts of a pivot joint and the electronics module to the chassis (or vice versa). Without the need for any gears or linkages the sensor is easy to mount thereby delivering additional cost reduction on the production line and improving product reliability and durability during its lifetime.

The PS2P-ARC measures changes in position relative to the sensor by detecting the movement of a sinusoidal magnetized arc magnet that is located in a separate housing and is only sensitive to the flux density co-planar with the IC surface.

The PS2P series is complemented by touchless linear (PS2P-LIN) and angular (PS2P-CON) position sensors. All sensors of the series will deliver the same level of precision and stability throughout their lifetime as on the first day they are installed - despite extremes of vibration, shock, temperature and contamination. As absolute sensors they will not lose the values even after a power failure.

APPLICATIONS

Off-Highway

- ▶ Tractor hitch position
- ▶ Boom loader position
- ▶ Excavator bucket position
- ▶ Telehandler position
- ▶ Forklift height and tilt
- ▶ Articulated vehicles pivot joint position

Automotive

- ▶ Active suspension

Marine

- ▶ Marine steering and throttle control
- ▶ Hydraulic arm position

Industrial

- ▶ Robotic arm position

PS2P-ARC

Play Resistant Arc Position Sensor

MECHANICAL SPECIFICATIONS

Life	Virtually unlimited
Air gap	2mm ±1mm
Magnet radius	23mm (Model M009) 31mm (Model M008)

ELECTRICAL SPECIFICATIONS

Linearity ¹	±1% absolute (±0.5% upon request)	
Angular range ²	110 degrees 90 degrees 45 degrees	
Output protocol ³	Analog (Ratiometric) PWM CAN Open CAN SAE J1939	
Output function	Standard Inverted Redundant	10% to 90% Vdc (CW) 90% to 10% Vdc (CCW) 10% to 90% Vdc (CW and CCW)
Switch	Programmable on request	
Resolution	Up to 12 bit	
Supply voltage	Analog and PWM CAN	5V ±10% 7V to 15V (25V on request) 7V to 32V
Supply current	Single version Redundant version CAN version	Typ 8.5 mA Typ 17 mA Typ 47 mA
Voltage protection	±10V	
Self-diagnostic features	Yes	

¹ Ferromagnetic materials close to the sensor (i.e. shaft, mounting surface) may affect the sensor's linearity.

² Other electrical rotational angles on request.

³ CAN protocol available for simple output versions only.

ENVIRONMENTAL SPECIFICATIONS

Operating and storage temperature ¹	-40° to +125°C
Shock	50g
Vibration	10-2000 Hz; 10g; A _{max} 0,75 mm
Sealing	IP67, IP69K

¹ Other specifications available.

CONNECTION SCHEME

Color	Simple output		Redundant output		Full-redundant output	CAN
	5V	7V to 15V	5V	7V to 15V		
Brown	Power supply	Power supply	Power supply	Power supply	Power supply 1	Power supply
Blue	Ground	Ground	Ground	Ground	Ground 1	Ground
Black	Signal output	Signal output	Signal output 1	Signal output 1	Ground 2	CAN High
White	n/a	n/a	Signal output 2	Signal output 2	Signal output 2	CAN Low
Red	n/a	n/a	n/a	n/a	Power supply 2	n/a
Yellow	n/a	n/a	n/a	n/a	Signal output 1	n/a
Grey	n/a	Not used	n/a	Not used	n/a	n/a

More instructions of use on www.piher.net. Connector assembly available on request.

PS2P-ARC

Play Resistant Arc Position Sensor

HOW TO ORDER (Example: PS2P-ARC-CE-M008-A-110S-05)

Simple output

PS2P-ARC - - - - - - -

Series	Magnet position	Magnet model	Output protocol ¹	Electric rotational angle ²	Output function	Voltage supply ³
	CE = on top LA = lateral	M008 M009	A = analogic P = PWM J = CAN SAE J1939 O = CAN OPEN	110 090 045	S = standard / CW I = inverted / CCW	05 = 5V ±10% RE = 7V-15V (A/PWM) / 7V-32V (CAN)

Redundant output

PS2P-ARC - - - - - - - R -

Series	Magnet position	Magnet model	Output protocol ¹	Electric rotational angle ²	Output function	Voltage supply ³
	CE = on top LA = lateral	M008 M009	A = analogic P = PWM	110 090 045	R = redundant	05 = 5V ±10% RE = 7V-15V

Full-redundant output

PS2P-ARC - - - - - - - F - - 05

Series	Magnet position	Magnet model	Output protocol ¹	Electric rotational angle ²	Output function	Voltage supply ³
	CE = on top LA = lateral	M008 M009	A = analogic P = PWM	110 090 045	F = full-redundant	05 = 5V ±10%

1 The analog output is ratiometric, proportional:
 - for supply voltage "5V" to input voltage;
 - for supply voltage "RE" to 5V.
 Default frequency for PWM versions is 200 Hz. Others on request.
 2 Other electrical rotational angles on request.
 3 Voltages up to 25V available on request.

MAGNET POSITION

On Top

Lateral

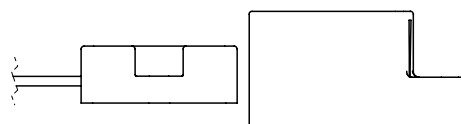
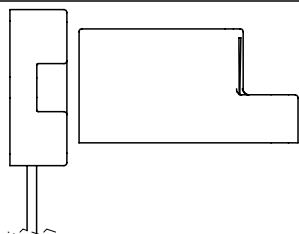

PS2P-ARC

Play Resistant Arc Position Sensor

OUTPUT CURVE

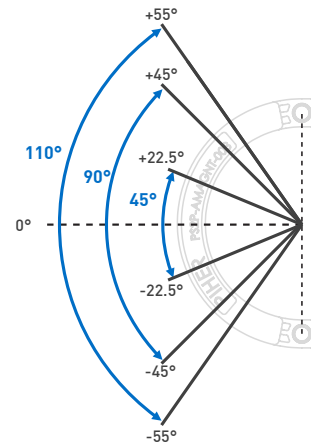
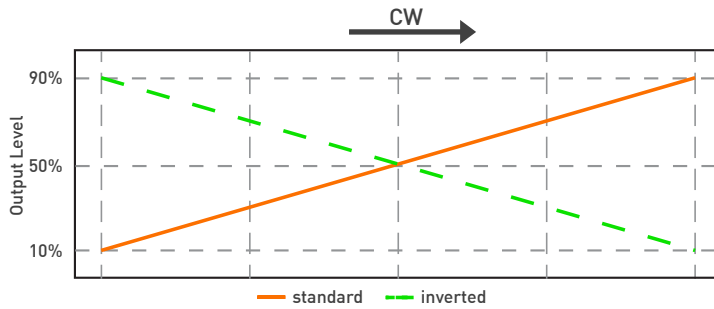

ERA	Mechanical Rotational Angle		
110° →	-55°	0°	+55°
90° →	-45°	0°	+45°
45° →	-22.5°	0°	+22.5°

Custom output functions available on request.

APPLICATION EXAMPLES



Tractor Rear Hitch Position



Active Suspension System (Torsion Bar)

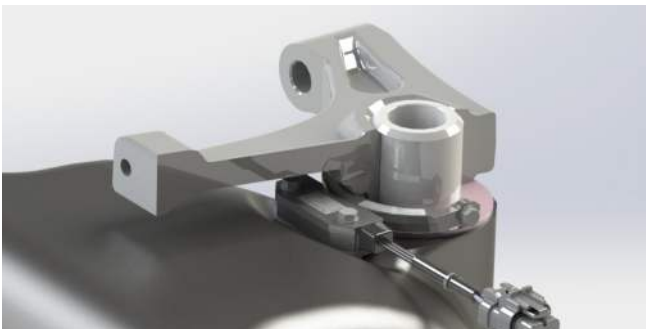

Marine Outboard Steering



Please always use the latest updated datasheets and 3D models published on our website.

Disclaimer:

The product information in this catalog is for reference purposes. Please consult for the most up to date and accurate design information. Piher Sensors & Controls S.A., its affiliates, agents, and employees, and all persons acting on its or their behalf (collectively, "Piher"), disclaim any and all liability for any errors, inaccuracies or incompleteness contained herein or in any other disclosure relating to any product described herein. Piher disclaims any and all liability arising out of the use or application of any product described herein to the maximum extent permitted by law. The product specifications do not expand or otherwise modify Piher's terms and conditions of sale, including but not limited to the warranty expressed therein, which apply to these products. No license, express or implied, by estoppel or otherwise, to any intellectual property rights is granted by this document or by any conduct of Piher. The products shown herein are not designed for use in medical, life-saving, or life-sustaining applications unless otherwise expressly indicated. Customers using or selling Piher products not expressly indicated for use in such applications do so entirely at their own risk and agree to fully indemnify Piher for any damages arising or resulting from such use or sale. Please contact authorized Piher personnel to obtain written terms and conditions regarding products designed for such applications. Product names and markings noted herein may be trademarks of their respective owners. Information contained in and/or attached to this catalogue may be subject to export control regulations of the European Community, USA, or other countries. Each recipient of this document is responsible to ensure that usage and/or transfer of any information contained in this document complies with all relevant export control regulations. If you are in any doubt about the export control restrictions that apply to this information, please contact the sender immediately. For any Piher Exports, Note: All products / technologies are EAR99 Classified commodities. Exports from the United States are in accordance with the Export Administration Regulations. Diversion contrary to US law is prohibited.

CONTACT

Piher Sensing Systems
 Polígono Industrial Municipal
 Vial T2, N°22
 31500 Tudela
 Spain

sales@piher.net

Europe: +34 948 820 450
Americas: +1 636 251 0855
Asia Pacific: +65 9641 8886
India: +91 9538 686 586

Rev:02032023 © 2023 Piher Sensors & Controls S.A.