

ARTESYN

AVD50B-48S3V3 SERIES

50 Watts 1/16 Brick Converter



PRODUCT DESCRIPTION

Advanced Energy's Artesyn AVD50B-48S3V3 series is a single output DC/DC converter with standard sixteenth-brick form factor and pin configuration. It delivers up to 15A output current with 3.3V output. Above 92.5% efficiency and excellent thermal performance makes it an ideal choice to supply power in computing and telecommunication applications.

AT A GLANCE

Total Power

50 Watts

Input Voltage

36 to 75 Vdc

of Outputs

Single

SPECIAL FEATURES

- Delivering up to 15A output
- Ultra-high efficiency 92.5% typ. at 9A load
- Wide input range: 36V to 75V
- Excellent thermal performance
- No minimum load requirement
- Basic isolation
- High power density
- Low output noise
- RoHS Directive(EU) 2015/863 (RoHS 3.0)
- Startup Pre-bias
- Remote control function
- Remote output sense
- Trim function: 80% to 110%
- Input under voltage lockout
- Output over current protection
- Output short protection
- Output over voltage protection
- Over temperature protection
- Industry standard sixteenth-brick pin-out outline
- SMT or through-hole option

SAFETY

- EN 62368-1
- EN / UL 60950-1
- CE Mark
- UKCA Mark

TYPICAL APPLICATIONS

- Datacom
- Telecommunication



MODEL NUMBERS

Standard	Output Voltage	Structure	Remote ON/OFF logic	RoHS Status
AVD50B-48S3V3B-6L	3.3Vdc	Baseplate	Negative	RoHS 3.0
AVD50B-48S3V3-6L	3.3Vdc	Open-frame	Negative	RoHS 3.0
AVD50B-48S3V3TL	3.3Vdc	Open-frame	Negative	RoHS 3.0

Order Information

AVO50B	-	48	S	3V3	P	B	-	6	L
①		②	③	④	⑤	⑥		⑦	⑧

①	Model series	AVD: high efficiency sixteenth brick series, 50: output power 50W
②	Input voltage	48: 36V to 75V input range, rated input voltage 48V
③	Output number	S: single output
④	Rated output voltage	3V3: 3.3V output
⑤	Remote ON/OFF logic	Default: negative logic; P: positive logic
⑥	Baseplate	B: with baseplate; default: open frame
⑦	Pin length	6: 3.8mm ± 0.25mm pin length; T: SMT Pin
⑧	RoHS status	L: RoHS Directive(EU) 2015/863 (RoHS 3.0)

Options

None

ELECTRICAL SPECIFICATIONS

Absolute Maximum Ratings

Stress in excess of those listed in the “Absolute Maximum Ratings” may cause permanent damage to the power supply. These are stress ratings only and functional operation of the unit is not implied at these or any other conditions above those given in the operational sections of this TRN. Exposure to any absolute maximum rated condition for extended periods may adversely affect the power supply’s reliability.

Table 1. Absolute Maximum Ratings						
Parameter	Model	Symbol	Min	Typ	Max	Unit
Input Voltage	Operating -Continuous	$V_{IN,DC}$	-	-	80	Vdc
	Non-operating -100mS		-	-	100	Vdc
Maximum Output Power	All	$P_{O,max}$	-	-	50	W
Ambient Operating Temperature	All	T_A	-40	-	+85	°C
Storage Temperature	All	T_{STG}	-55	-	+125	°C
Isolation Voltage ¹	All		-	-	1500	Vdc
Input to output						
Voltage at remote ON/OFF pin	All		-0.3	-	12	Vdc
Humidity (non-condensing)	Operating	All	-	-	95	%
	Non-operating	All	-	-	95	%

Note 1 - 1mA for 60s, slew rate of 1500V/10s. Basic insulation, pollution degree 2

ELECTRICAL SPECIFICATIONS

Input Specifications

Table 2. Input Specifications						
Parameter	Condition ¹	Symbol	Min	Typ	Max	Unit
Operating Input Voltage, DC	All	$V_{IN,DC}$	36	48	75	Vdc
Turn-on Voltage Threshold	$I_O = I_{O,max}$	$V_{IN,ON}$	31	-	36	Vdc
Turn-off Voltage Threshold	$I_O = I_{O,max}$	$V_{IN,OFF}$	30	-	35	Vdc
Lockout Voltage Hysteresis	$I_O = I_{O,max}$		1	-	3	V
Maximum Input Current ($I_O = I_{O,max}$)	$V_{IN,DC} = 36Vdc$	$I_{IN,max}$	-	-	2	A
Input Reflected Ripple Current	Through 12uH inductor	$I_{IN,typ}$	-	18	-	mA
Recommended Input Fuse	Fast blow external fuse recommended		-	-	5	A
Recommended External Input Capacitance	Low ESR capacitor recommended	C_{IN}	100	-	-	uF
Operating Efficiency	$T_A = 25\text{ }^{\circ}C$ $I_O = 60\% I_{O,max}$	η	-	92.5	-	%

Note 1 - $T_A = 25\text{ }^{\circ}C$, airflow rate = 400 LFM, $V_{in} = 48Vdc$, nominal V_{out} unless otherwise indicated.

ELECTRICAL SPECIFICATIONS

Output Specifications

Table 3. Output Specifications						
Parameter	Condition ¹	Symbol	Min	Typ	Max	Unit
Factory Set Voltage	$V_{IN,DC} = 48Vdc$ $I_O = I_{O,max}$	V_O	3.25	3.3	3.35	Vdc
Total Regulation	Inclusive of line, load temperature change, warm-up drift	V_O	3.2	3.3	3.4	Vdc
Output Voltage Line Regulation	All	$\pm\%V_O$	-	0.15	-	%
		$\pm V_O$	-	5	-	mV
Output Voltage Load Regulation	All	$\pm\%V_O$	-	0.15	-	%
		$\pm V_O$	-	5	-	mV
Output Voltage Temperature Regulation	All	$\%V_O$	-	-	0.02	%/°C
Output Voltage Trim Range	All	$\%V_O$	80	-	110	%
Output Ripple, pk-pk	Measure with a 1uF ceramic capacitor in parallel with a 10uF tantalum capacitor, 0 to 20MHz bandwidth	V_O	-	40	-	mV _{PK-PK}
Output Current	All	I_O	0	-	15	A
Output DC current-limit inception ²	All	I_O	16.5	-	34	A
V_O Load Capacitance ³	All	C_O	220	-	10000	uF
V_O Dynamic Response	Peak Deviation Settling Time 25%~50%~75% 25% load change slew rate = 0.1A/us	$\pm V_O$ T_s	- -	35 50	- -	mV uSec
	Peak Deviation Settling Time 50%~75%~25% 25% load change slew rate = 1A/us	$\pm V_O$ T_s	- -	60 100	- -	mV uSec
Turn-on transient	Rise time	$I_O = I_{O,max}$	T_{rise}	-	25	mS
	Turn-on delay time	$I_O = I_{O,max}$	$T_{turn-on}$	-	5	mS
	Output voltage overshoot	$I_O = 0$	$\%V_O$	-	-	5
Switching frequency	All	f_{sw}	-	350	-	KHz
Remote ON/OFF control (positive logic)	Off-state voltage	All	-0.3	-	1.2	V
	On-state voltage	All	3.5	-	12	V
Remote ON/OFF control (negative logic)	Off-state voltage	All	3.5	-	12	V
	On-state voltage	All	-0.3	-	1.2	V

Note 1 - $T_a = 25^\circ C$, airflow rate = 400 LFM, $V_{in} = 48Vdc$, nominal V_{out} unless otherwise noted.

Note 2 - Hiccup: auto-restart when over-current condition is removed.

Note 3 - High frequency and low ESR is recommended.

ELECTRICAL SPECIFICATIONS

Output Specifications

Table 3. Output Specifications, con't						
Parameter	Condition ¹	Symbol	Min	Typ	Max	Unit
Output voltage trim range	All	%V _O	80	-	110	%
Output over-voltage protection ⁴	All	V _O	3.9	-	5	V
Output over-temperature protection ⁵	All	T	-	120	-	°C
Over-temperature hysteresis	All	T	-	10	-	°C
+ Sense	All	%V _O	-	-	5	%
- Sense	All	%V _O	-	-	5	%
MTBF	Telcordia SR-332-2006; 80% load, 300LFM, 40 °C T _A		-	2.0	-	10 ⁶ h

Note 4 - Hiccup, auto-restart when over-voltage condition is removed.

Note 5 - Auto recovery.

ELECTRICAL SPECIFICATIONS

AVD50B-48S3V3 Performance Curves

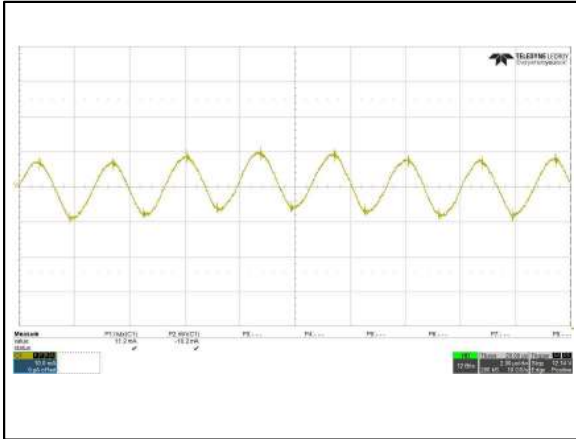

Figure 1: AVD50B-48S3V3 Input Reflected Ripple Current Waveform
Ch 1: lin (2µs/div, 10mA/div)

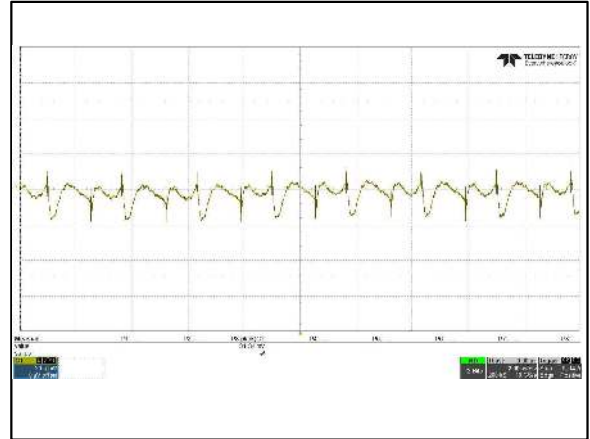

Figure 2: AVD50B-48S3V3 Ripple and Noise Measurement
Ch 1: Vo (2µs/div, 20mV/div)

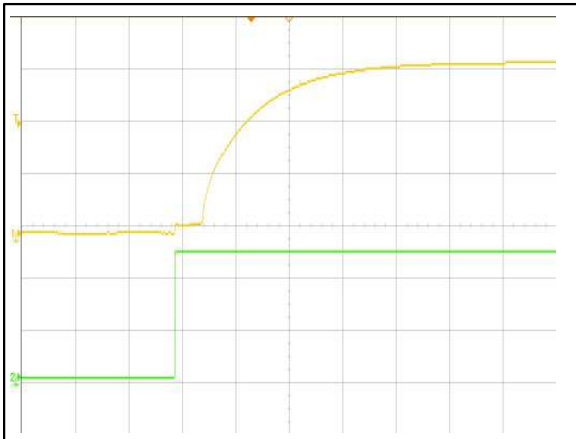

Figure 3: AVD50B-48S3V3 Turn On Characteristic (10ms/div)
Ch 1: Vo (1V/div) Ch 2: Vin (20V/div)

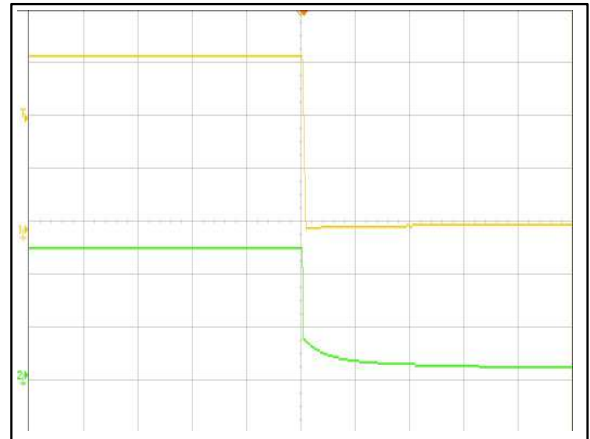

Figure 4: AVD50B-48S3V3 Turn Off Characteristic (5ms/div)
Ch 1: Vo (1V/div) Ch 2: Vin (20V/div)

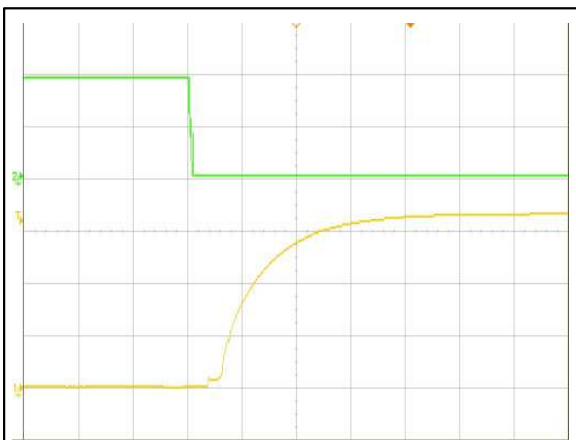

Figure 5: AVD50B-48S3V3 Remote ON Waveform (10ms/div)
Ch 1: Vo (1V/div) Ch 2: Remote ON (2V/div)

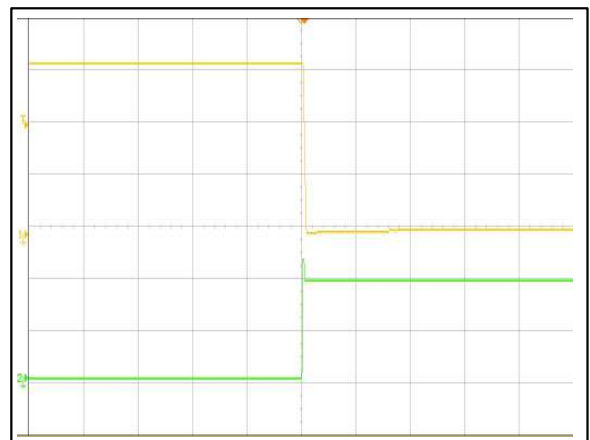

Figure 6: AVD50B-48S3V3 Remote OFF Waveform (5ms/div)
Ch 1: Vo (1V/div) Ch 2: Remote OFF (2V/div)

ELECTRICAL SPECIFICATIONS

AVD50B-48S3V3 Performance Curves

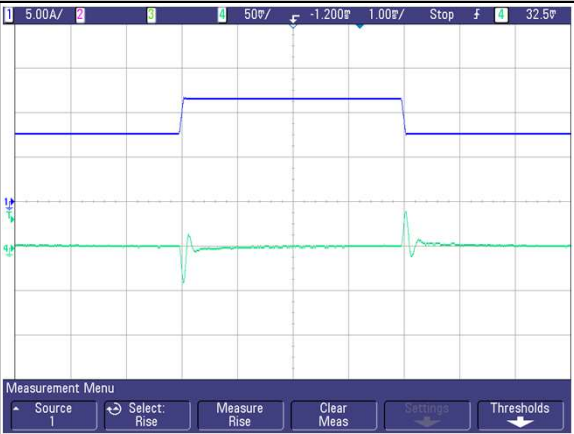

Figure 7: AVD50B-48S3V3 Transient Response (1mS/div)
 0.1A/us slew rate
 Ch 4: Vo (50mV/div) Ch 1: Io (5A/div)

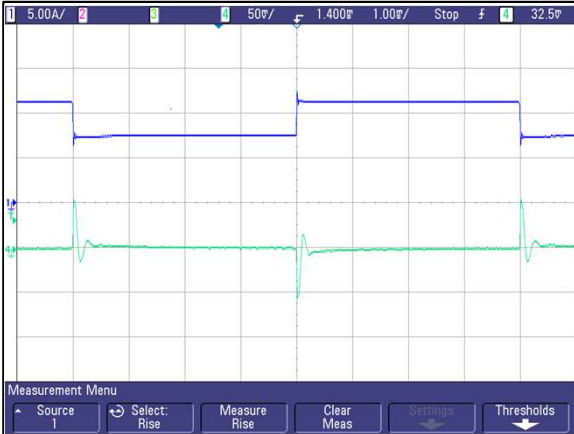

Figure 8: AVD50B-48S3V3 Transient Response (1mS/div)
 1A/us slew rate
 Ch 4: Vo (50mV/div) Ch 1: Io (5A/div)

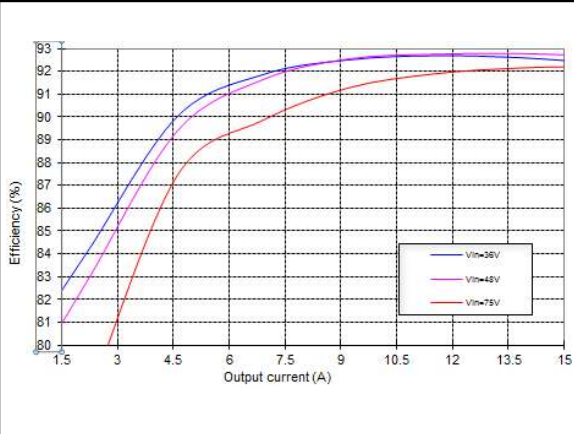

Figure 9: AVD50B-48S3V3 Efficiency Curves @ 25 degC
 Loading: Io = 10% increment to 15A

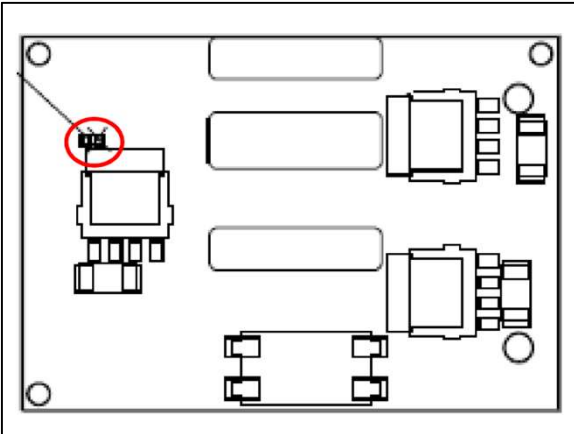

Figure 10: AVD50B-48S3V3 OTP test point (Open-frame module)

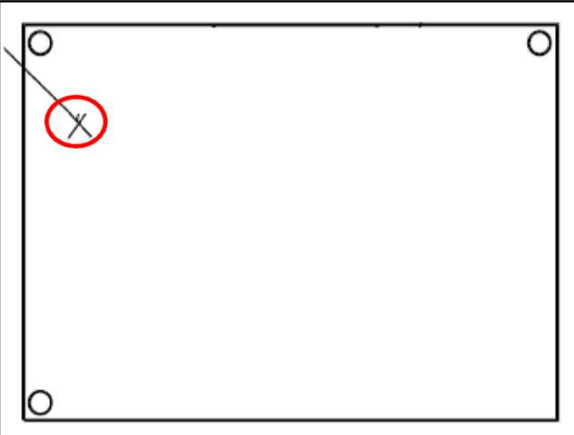
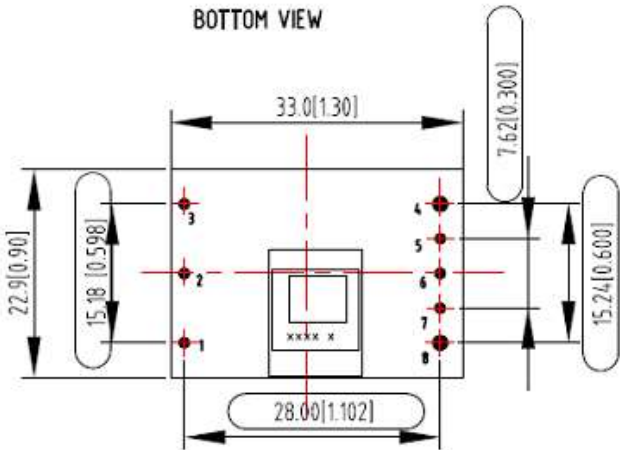

Figure 11: AVD50B-48S3V3B OTP test point (Module with baseplate)

MECHANICAL SPECIFICATIONS

Mechanical Outlines – Baseplate Module (unit: mm)



SIDE VIEW

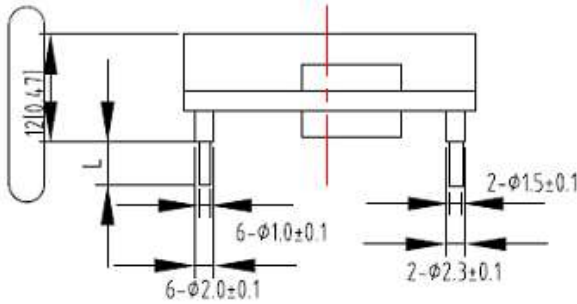

UNIT: mm[inch]

L=3.80±0.25mm

TOLERANCE: X.Xmm±0.5mm[X.XX in.±0.02in.]

X.XXmm±0.25mm[X.XXX in.±0.01in.]

Notes: Dimensions within the box are critical dimensions.

Figure 12 Baseplate module mechanical diagram

Notes: Depth penetration into base plate, of M3 screws used at baseplate mounting holes, not to exceed maximum of 3.0mm.

MECHANICAL SPECIFICATIONS

Mechanical Outlines – Open-frame Module (unit: mm)

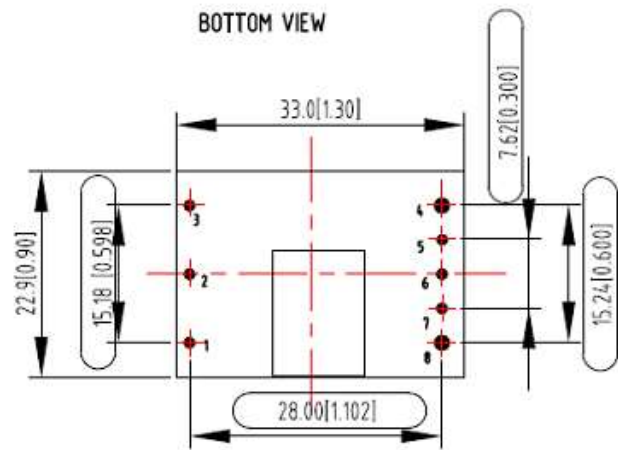

SIDE VIEW

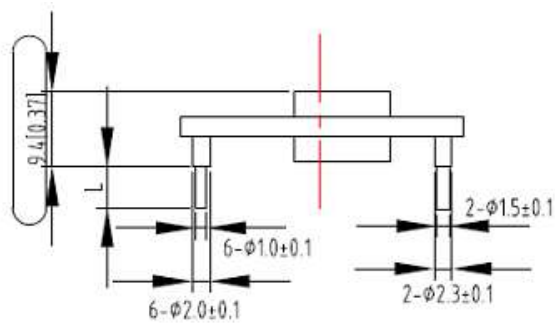

UNIT: mm[inch]

L=3.80±0.25mm

TOLERANCE: X.Xmm±0.5mm[X.XX in.±0.02in.]

X.XXmm±0.25mm[X.XXX in.±0.01in.]

Notes: Dimensions within the box are critical dimensions.

Figure 13 Open frame module mechanical diagram

MECHANICAL SPECIFICATIONS

Mechanical Outlines – Surface Mounted Module (unit: mm)

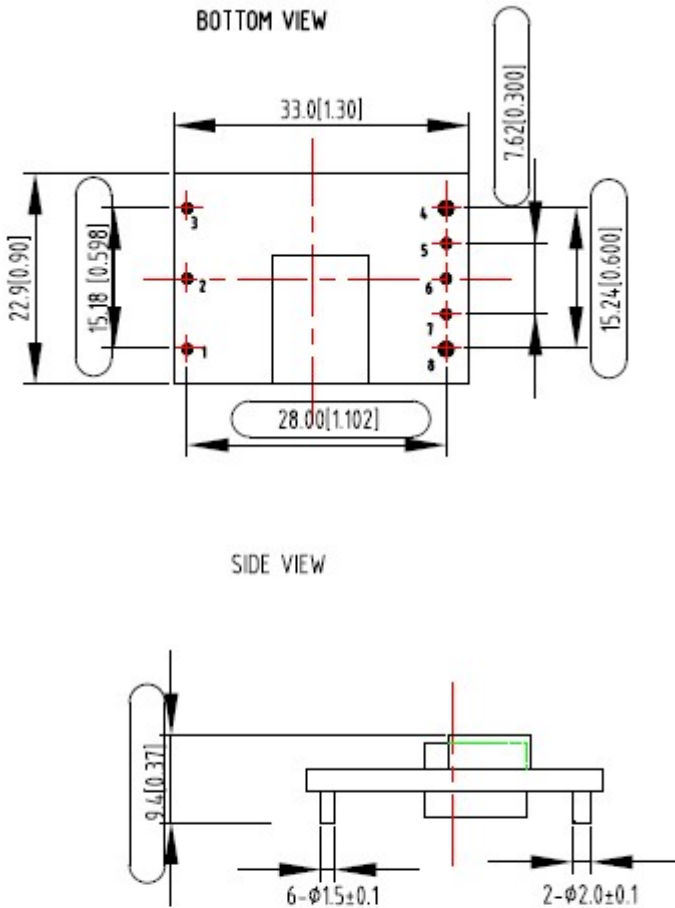

UNIT: mm[inch]

TOLERANCE: X.Xmm±0.5mm[X.XX in.±0.02in.]
X.XXmm±0.25mm[X.XXX in.±0.01in.]

Notes: Dimensions within the box are critical dimensions.

Figure 14 Surface mounted module mechanical diagram

MECHANICAL SPECIFICATIONS

Pin Designations

Pin No	Name	Function
1	Vin+	Positive input terminal
2	Remote ON/OFF	ON/OFF control terminal
3	Vin-	Negative input terminal
4	Vo-	Negative output terminal
5	Sense-	Negative remote sense
6	Trim	Output voltage trim
7	Sense+	Positive remote sense
8	Vo+	Positive output terminal

Pin Length Option

Device code suffix	L
-4	4.8mm ± 0.25mm
-6	3.8mm ± 0.25 mm
-8	2.8mm ± 0.25 mm
None	5.8mm ± 0.25 mm

ENVIRONMENTAL SPECIFICATIONS

EMC Immunity

AVD50B-48S3V3 series power supply is designed to meet the following EMC immunity specifications.

Table 4. Environmental Specifications		
Document	Description	Criteria
EN55032, Class A Limits	Conducted and Radiated EMI Limits. DC input port	/
IEC/EN 61000-4-2, Level 3	Electromagnetic Compatibility (EMC) - Testing and measurement techniques - Electrostatic discharge immunity test. Enclosure Port	B
IEC/EN 61000-4-6, Level 2	Electromagnetic Compatibility (EMC) - Testing and measurement techniques, Continuous Conducted Interference. DC input port	A
IEC/EN 61000-4-4, Level3	Electromagnetic Compatibility (EMC) - Testing and measurement techniques, Electrical Fast Transient. DC input port.	B
IEC/EN 61000-4-5	Electromagnetic Compatibility (EMC) - Testing and measurement techniques, Immunity to surges - 600V common mode and 600V differential mode for DC ports	B
EN61000-4-29	Electromagnetic Compatibility (EMC) - Testing and measurement techniques, Voltage Dips and short interruptions and voltage variations. DC input port	B

Criterion A: Normal performance during and after test.

Criterion B: For EFT and surges, low-voltage protection or reset is not allowed. Temporary output voltage fluctuation ceases after disturbances ceases, and from which the EUT recovers its normal performance automatically. For Dips and ESD, output voltage fluctuation or reset is allowed during the test, but recovers to its normal performance automatically after the disturbance ceases.

Criterion C: Temporary loss of output, the correction of which requires operator intervention.

Criterion D: Loss of output which is not recoverable, owing to damage to hardware

ENVIRONMENTAL SPECIFICATIONS

Safety Certifications

The AVD50B-48S3V3 series module is intended for inclusion in other equipment and the installer must ensure that it is in compliance with all the requirements of the end application. This product is only for inclusion by professional installers within other equipment and must not be operated as a stand alone product.

Table 5. Safety Certifications for AVD50B-48S3V3 series module

Standard	Agency	Description
UL/CSA 60950	UL	US and Canada Requirements
EN 60950	TUV	European Requirements
EN 62368-1	TUV	European Requirements
CE Mark	CE	European Requirements
UKCA Mark	UKCA	UK Requirements

ENVIRONMENTAL SPECIFICATIONS

Operating Temperature

The AVD50B-48S3V3 power supply will start and operate within stated specifications at an ambient temperature from -40 °C to 85 °C under all load conditions. The storage temperature is -55 °C to 125 °C.

Thermal Considerations

The converter is designed to operate in different thermal environments and sufficient cooling must be provided. Proper cooling of the DC/DC converter can be verified by measuring the temperature at the test point as shown in the Figure 15. The temperature at this point should not exceed the max values in the table 6.

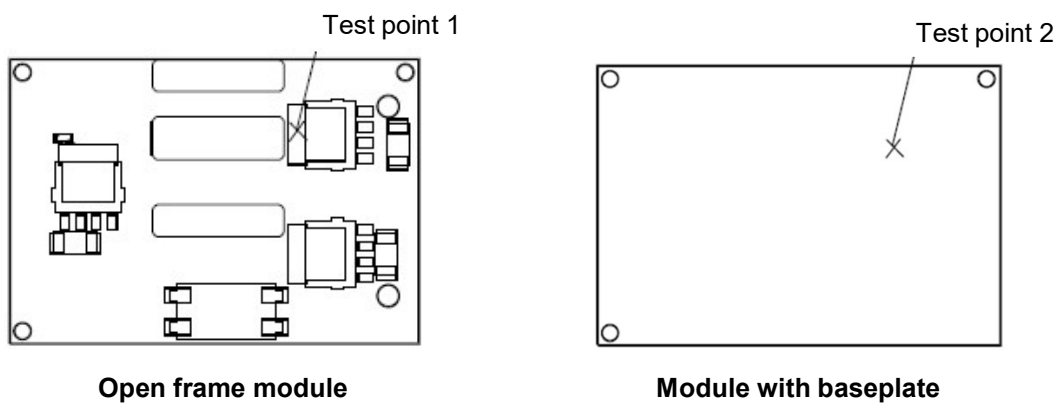
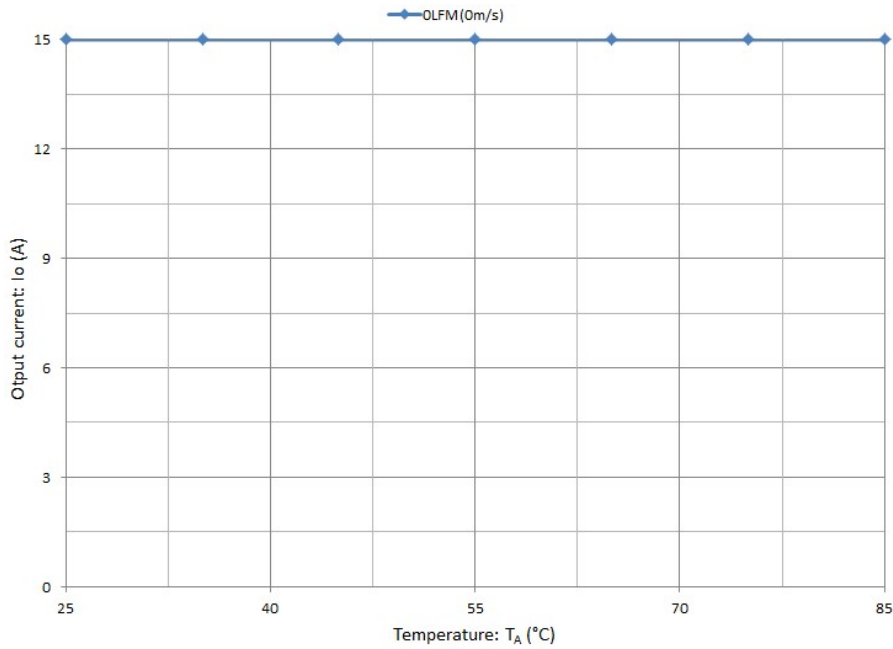

Figure 15 Module temperature test point

Table 6. Temperature limit of the test point	
Test Point	Temperature Limit
Test point 1	130 °C
Test point 2	120 °C

ENVIRONMENTAL SPECIFICATIONS

For a typical application, figure 16 shows the derating of output current vs. ambient air temperature at different air velocity.



AVD50B-48S3V3-6L and AVD50B-48S3V3TL

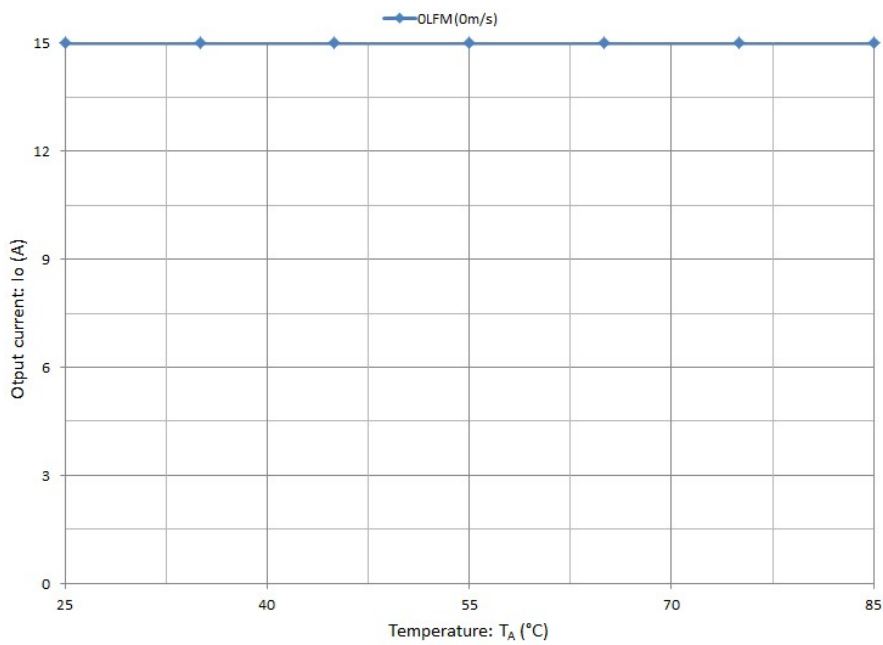

AVD50B-48S3V3B-6L

Figure 16 Output power derating, 48Vin, air flowing across the converter (from Vin- to Vin+)

ENVIRONMENTAL SPECIFICATIONS

Qualification Testing

Parameter	Unit (pcs)	Test condition
Halt test	4-5	$T_{a,min}$ -30 °C to $T_{a,max}$ +25 °C, 10 °C step, V_{in} = min to max, 0 ~ 100% load
Vibration	3	Frequency range: 5Hz ~ 20Hz, 20Hz ~ 200Hz, A.S.D: 1.0m ² /s ³ , -3db/oct, axes of vibration: X/Y/Z. Time: 30min/axes
Mechanical Shock	3	30g, 6ms, 3axes, 6directions, 3time/direction
Thermal Shock	3	-55 °C to 125 °C, unit temperature 20 cycles
Thermal Cycling	3	-40 °C to 85 °C, temperature change rate: 1°C/min, cycles: 2cycles
Humidity	3	40 °C, 95%RH, 48h
Solder Ability	15	IPC J-STD-002C-2007

APPLICATION NOTES

Typical Application

Below is the typical application of the AVD50B-48S3V3 series power supply.

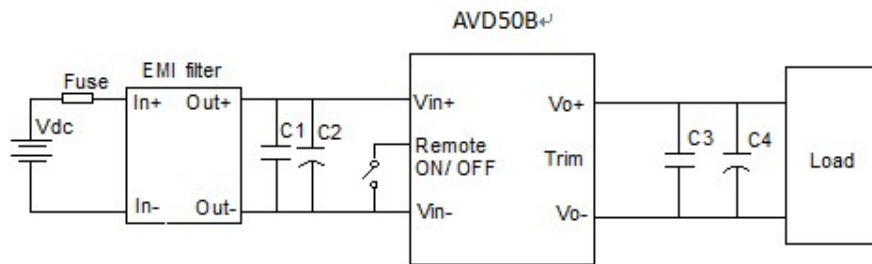

Figure 17 Typical application

C1: 100 μ F/100V electrolytic capacitor; P/N: UPM2A101MPD (Nichicon) or equivalent caps

C2, C3: 1 μ F/100V X7R ceramic capacitor, P/N: C3216X7R2A105KT0L0S (TDK) or equivalent caps

C4: 470 μ F Oscon capacitor, P/N: 16SEPC470M or equivalent caps

Fuse: External fast blow fuse with a rating of 5A. The recommended fuse model is 0453005.MR from LITTLEFUSE.

EMI filter: see Figure 22.

APPLICATION NOTES

Remote ON/OFF

Negative remote ON/OFF logic is available in AVD50B-48S3V3. The logic is CMOS and TTL compatible.

The voltage between pin Remote ON/OFF and pin Vin- must not exceed the range listed in table 3 to ensure proper operation. The external Remote ON/OFF circuit is highly recommended as shown in figure 18.

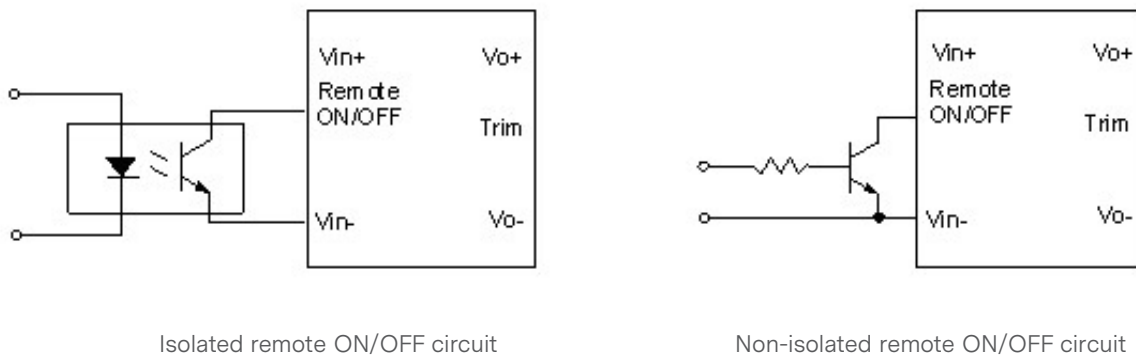

Figure 18 External Remote ON/OFF circuit

APPLICATION NOTES

Trim Characteristics

Connecting an external resistor between Trim pin and Vo- pin will decrease the output voltage. While connecting it between Trim and Vo+ will increase the output voltage. The following equations determine the external resistance to obtain the trimmed output voltage.

$$R_{adj-down} = \frac{510}{\Delta} - 10.2(K\Omega)$$

$$R_{adj-up} = \frac{5.1 \times V_{nom} \times (100 + \Delta)}{1.225 \times \Delta} - \frac{510}{\Delta} - 10.2(K\Omega)$$

Δ : Output error rate against nominal output voltage.

$$\Delta = \frac{100 \times (V_{nom} - V_0)}{V_{nom}}$$

V_{nom} : Nominal output voltage.

For example, to get 3.63V output, the trimming resistor is

$$\Delta = \frac{100 \times (V_{nom} - V_0)}{V_{nom}} = \frac{100 \times (3.63 - 3.3)}{3.3} = 10$$

$$R_{adj-up} = \frac{5.1 \times 3.3 \times (100 + 10)}{1.225 \times 10} - \frac{510}{10} - 10.2 = 89.9(K\Omega)$$

When trimming up, the output current should be decreased accordingly so as not to exceed the maximum output power.

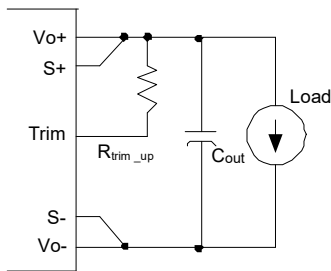

Figure 19 Trim up

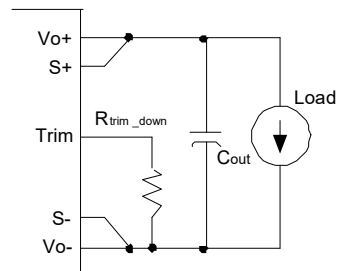

Figure 20 Trim down

For AVD50B-48S3V3, if the sense compensate function is not necessary, connect S+ to Vo+ and S- to Vo- directly.

APPLICATION NOTES

Input Ripple & Output Ripple & Noise Test Configuration

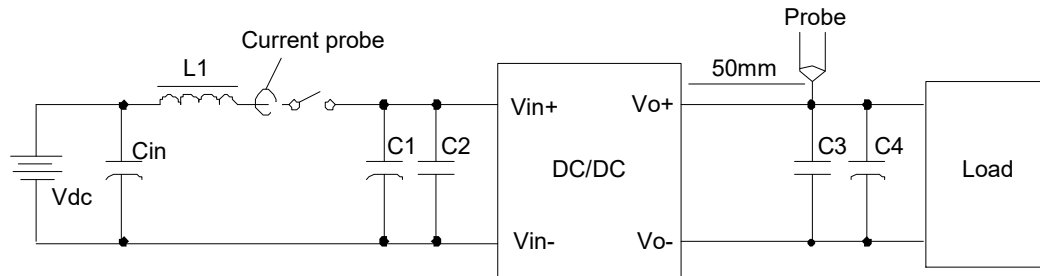

Figure 21 Input ripple & output ripple & noise test configuration

Vdc: DC power supply

L1: 12uH

Cin: 220uF/100V typical

C1 ~ C4: See Figure 17

Note - Using a coaxial cable with series 50ohm resistor and 0.68uF ceramic capacitor or a ground ring of probe to test output ripple & noise is recommended.

EMC Test configuration

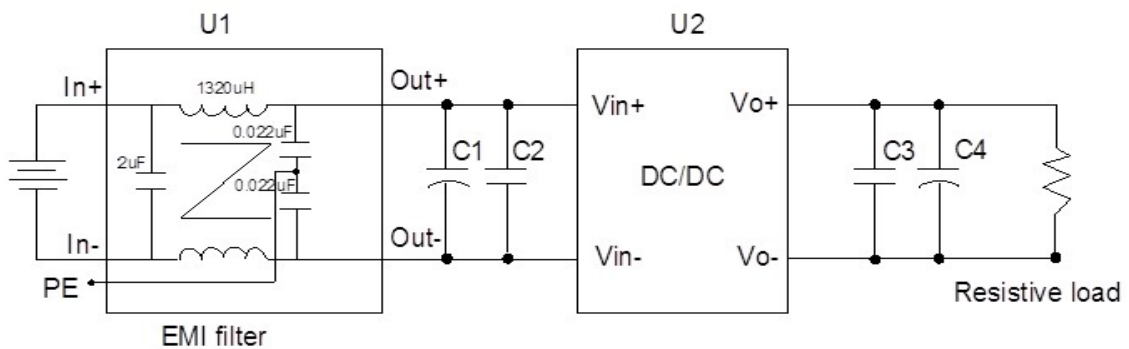

U1: Input EMC filter

U2: Module to test, AVD50B-48S3V3

C1 ~ C4: See Figure 17

Figure 22 EMC Test configuration

APPLICATION NOTES

Soldering

The AVD50B-48S3V3 series is intended for standard manual, reflow or wave soldering.

	Product Requirement	Product Name
R6	Wave soldering	AVD50B-48S3V3B-6L AVD50B-48S3V3-6L

When wave soldering is used, the temperature on pins is specified to maximum 260 °C for maximum 7s.

When soldering by hand, the iron temperature should be maintained at 300 °C to 380 °C and applied to the converter pins for less than 10s. Longer exposure can cause internal damage to the converter. Cleaning of solder joint can be performed with cleaning solvent IPA or simulative.

The below products are intended for standard reflow soldering.

	Product Requirement	Product Name
R6	Reflow soldering	AVD50B-48S3V3-6L AVD50B-48S3V3TL

When reflow soldering is used, please refer to following fig for recommended temperature profile parameters.

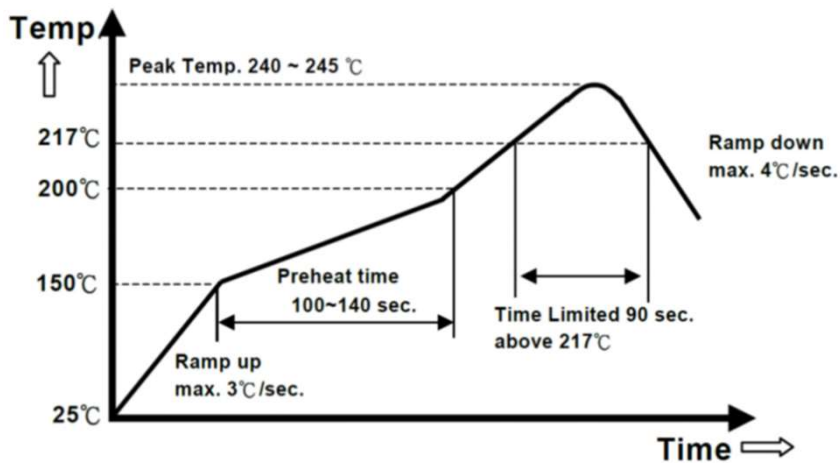

APPLICATION NOTES

Package Information

Package type

Moisture sensitivity level 3, moisture barrier bags.

Minimal package QTY

192 pcs.

Package disassembly

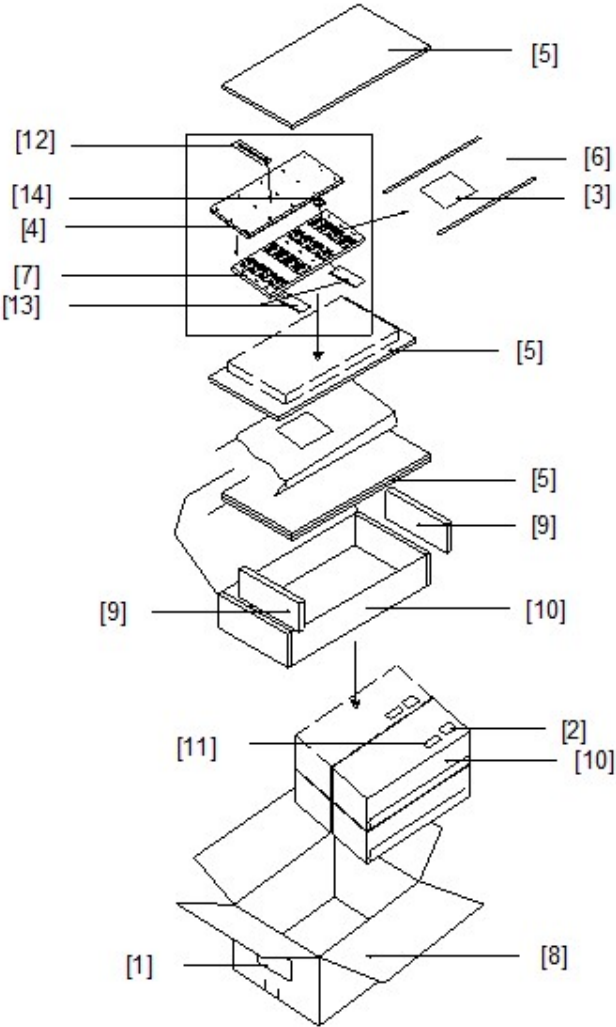
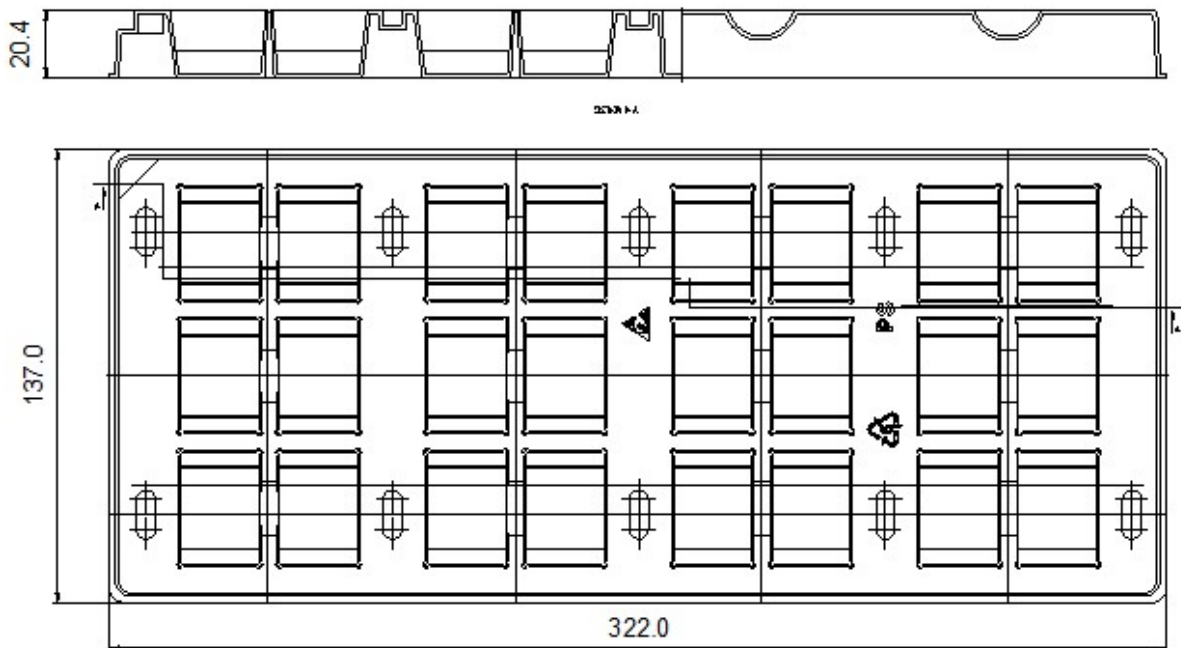

Figure 23 Package disassembly

APPLICATION NOTES

Table 7. Assemblies description	
No.	Description
1	Shipping label
2	Moisture proof identification label
3	Moisture proof caution label
4	Tray cover
5	Anti-static PE foam 1
6	Moisture barrier bag
7	Tray
8	Shipping carton
9	Anti-static PE foam 2
10	Inner box
11	Model barcode label
12	Humidity indicating card
13	Desiccant
14	Model

Package tray information



RECORD OF REVISION AND CHANGES

Issue	Date	Description	Originators
1.0	08.08.2017	First Issue	X. Sun
1.1	12.17.2019	Update soldering information	J. Zhang
1.2	02.24.2020	Update RoHS information	E. Bai
1.3	03.17.2022	Update OCP point and add UKCA Mark	K. Wang
1.4	04.15.2022	Update OCP point from 31A to 34A	K. Wang



For international contact information,
visit advancedenergy.com.

powersales@aei.com (Sales Support)
productsupport.ep@aei.com (Technical Support)
+1 888 412 7832

ABOUT ADVANCED ENERGY

Advanced Energy (AE) has devoted more than three decades to perfecting power for its global customers. AE designs and manufactures highly engineered, precision power conversion, measurement and control solutions for mission-critical applications and processes.

Our products enable customer innovation in complex applications for a wide range of industries including semiconductor equipment, industrial, manufacturing, telecommunications, data center computing, and medical. With deep applications know-how and responsive service and support across the globe, we build collaborative partnerships to meet rapid technological developments, propel growth for our customers, and innovate the future of power.

PRECISION | POWER | PERFORMANCE

Specifications are subject to change without notice. Not responsible for errors or omissions. ©2020 Advanced Energy Industries, Inc. All rights reserved. Advanced Energy®, and AE® are U.S. trademarks of Advanced Energy Industries, Inc.