



American Opto Plus LED Corp.

L955MWC-ZS

3.5 x 2.8 x 1.9mm White PLCC-2

DATA SHEET UPDATE HISTORY:

- **Version 1.0 – April 6, 2011**
 - Original data sheet creation
- **Version 1.1 – May 8, 2013**
 - Junction Temperature, Solder Point, Ambient ratings added
 - Bin code table adjusted
 - Updated derating curve (Forward Current vs. Ambient Temperature)
- **Version 1.2 – April 7, 2014**
 - Package Outline drawing revised
- **Version 2.0 – May 29, 2014**
 - Junction Solder Point, Ambient ratings adjusted
 - Updated derating curve (Forward Current vs. Ambient Temperature)
 - Updated ESD 2000V
- **Version 3.0 – November 5, 2014**
 - Luminous intensity increased
 - Voltage bin table adjusted
- **Version 3.1 – December 19, 2014**
 - Operating Temperature revised to -40 ~ +100 °C



American Opto Plus LED Corp.

L955MWC-ZS

3.5 x 2.8 x 1.9mm White PLCC-2

PACKAGE OUTLINES:

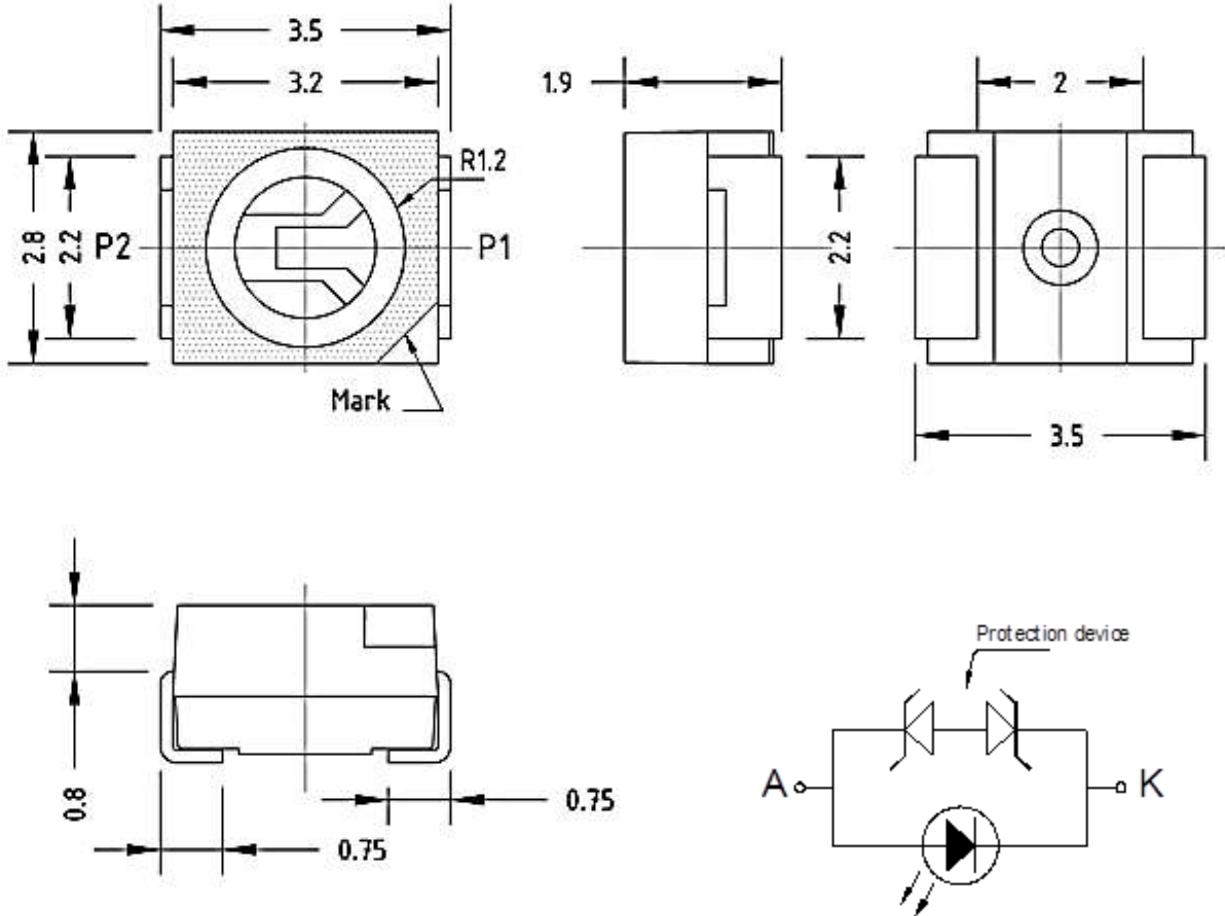

Item	Materials
Package	Heat-Resistant Polymer
Encapsulating Resin	Silicone
Electrodes	Ag Plating Copper Alloy

Chip Material	Chip Emitted	Lens Color	Viewing Angle
InGaN	White	Yellow	120°

Notes:

1. All dimensions are in mm; tolerance is 0.2mm
2. Electrical Connection between all Cathodes is Recommended



American Opto Plus LED Corp.

L955MWC-ZS

3.5 x 2.8 x 1.9mm White PLCC-2

ABSOLUTE MAXIMUM RATINGS

(Ta=25°C)

Parameter	Symbol	Max Rating	Unit
Power Dissipation	P _D	105	mW
Peak Pulsed Forward Current	I _{FP}	100	mA
DC Forward Current	I _F	30	mA
Reverse Voltage	V _R	5	V
Junction Temperature	T _J	115	°C
Junction / Solder Point	R _{th J_s}	370	°C/W
Junction / Ambient	R _{th J_a}	425	°C/W
Operating Temperature Range	T _{OPR}	-40~+100	°C
Storage Temperature Range	T _{STG}	-40~+100	°C
Solder Temperature	T _{SOL}	265°C for 10 sec.	

I_{FP} conditions: Pulse Width ≤ 10 msec and duty ≤ 1/10

*R_{th J_a} results from mounting on PC board FR4 (PCB Size 16*10mm)*

OPTICAL-ELECTRICAL CHARACTERISTICS

(Ta=25°C)

Parameter	Symbol	Test Condition	Min	Typ	Max	Unit
Luminous Intensity	I _v	I _F = 20mA	2000	2600	3000	mcd
Forward Voltage	V _F	I _F = 20mA	--	3.1	3.5	V
Chromaticity Coordinate	X	I _F = 20mA	--	0.31	--	--
Chromaticity Coordinate	Y	I _F = 20mA	--	0.32	--	--

Luminous intensity tolerance is ±10%



American Opto Plus LED Corp.

L955MWC-ZS

3.5 x 2.8 x 1.9mm White PLCC-2

LUMINOUS INTENSITY BIN TABLE

IF=20mA

Rank name	Min (mcd)	Max (mcd)
1	2000	2200
2	2200	2400
3	2400	2600
4	2600	2800
5	2800	3000

Tolerance for each bin limit is $\pm 10\%$

VOLTAGE BIN TABLE

IF=20mA

Rank name	Min (V)	Max (V)
A	2.8	2.9
B	2.9	3.0
C	3.0	3.1
D	3.1	3.2
E	3.2	3.3
F	3.3	3.4
G	3.4	3.5

Tolerance for each bin limit is $\pm 0.05V$



American Opto Plus LED Corp.

L955MWC-ZS

3.5 x 2.8 x 1.9mm White PLCC-2

CHROMATICITY DIAGRAM

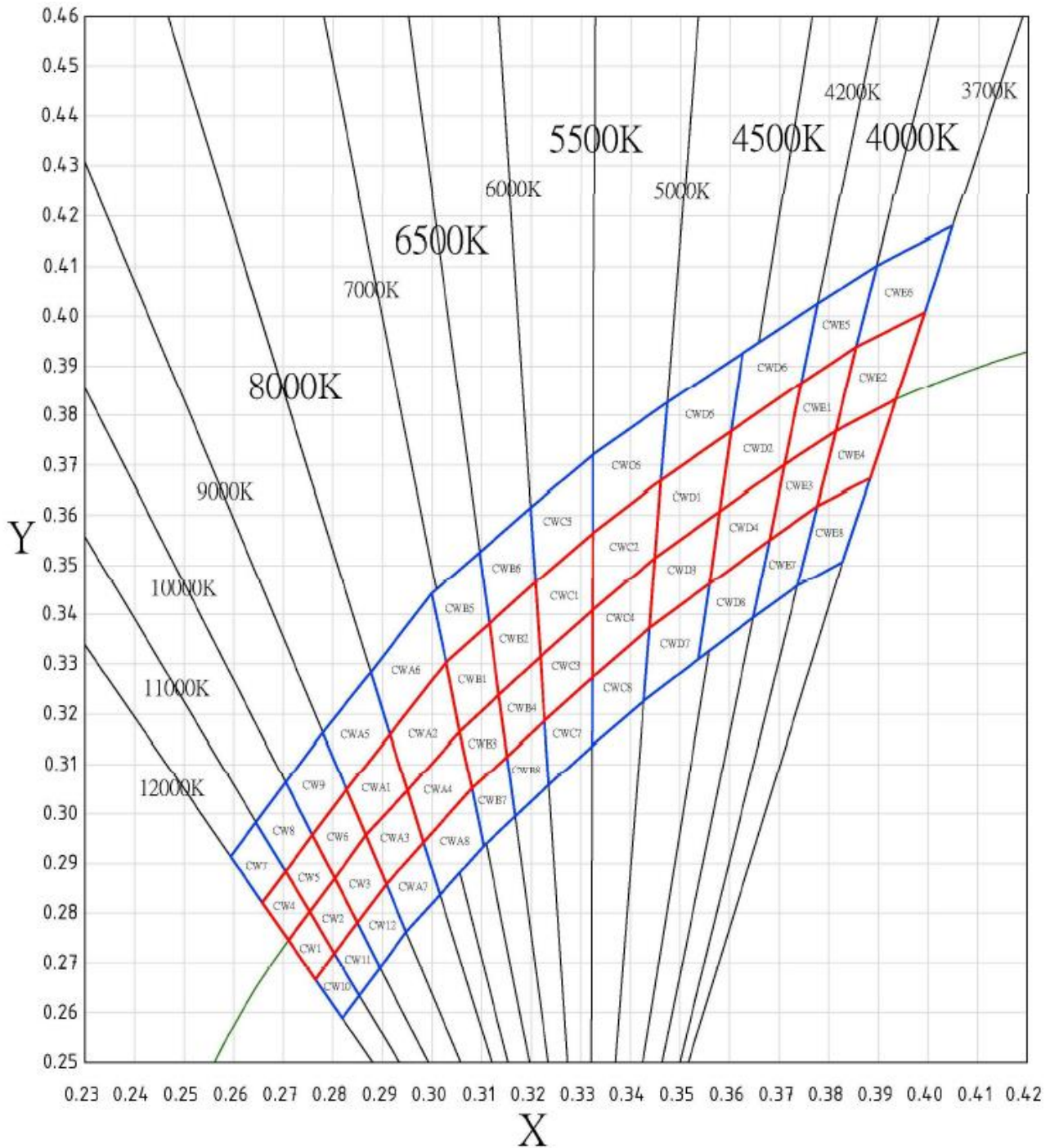



American Opto Plus LED Corp.

L955MWC-ZS

3.5 x 2.8 x 1.9mm White PLCC-2

COLOR RANKS

CW 1					CW 2				
x	0.27650	0.27110	0.27540	0.28030	x	0.28030	0.27540	0.28040	0.28500
y	0.26670	0.27460	0.28030	0.27190	y	0.27190	0.28030	0.28700	0.27810
CW 3					CW 4				
x	0.28500	0.28040	0.28670	0.29080	x	0.27110	0.26580	0.27050	0.27540
y	0.27810	0.28700	0.29570	0.28590	y	0.27460	0.28210	0.28840	0.28030
CW 5					CW 6				
x	0.27540	0.27050	0.27590	0.28040	x	0.28040	0.27590	0.28280	0.28670
y	0.28030	0.28840	0.29570	0.28700	y	0.28700	0.29570	0.30490	0.29570
CW 7					CW 8				
x	0.26580	0.25940	0.26450	0.27050	x	0.27050	0.26450	0.27050	0.27590
y	0.28210	0.29140	0.29820	0.28840	y	0.28840	0.29820	0.30630	0.29570
CW 9					CW 10				
x	0.27590	0.27050	0.27800	0.28280	x	0.28190	0.27650	0.28030	0.28540
y	0.29570	0.30630	0.31630	0.30490	y	0.25890	0.26670	0.27190	0.26350
CW 11					CW 12				
x	0.28540	0.28030	0.28500	0.28950	x	0.28950	0.28500	0.29080	0.29480
y	0.26350	0.27190	0.27810	0.26900	y	0.26900	0.27810	0.28590	0.27620
CWA1					CWA2				
x	0.28670	0.28280	0.29150	0.29510	x	0.29510	0.29150	0.30290	0.30570
y	0.29570	0.30490	0.31590	0.30470	y	0.30470	0.31590	0.33040	0.31660
CWA3					CWA4				
x	0.29080	0.28670	0.29510	0.29830	x	0.29830	0.29510	0.30560	0.30810
y	0.28590	0.29570	0.30470	0.29420	y	0.29420	0.30470	0.31650	0.30510
CWA5					CWA6				
x	0.28280	0.27800	0.28770	0.29150	x	0.29150	0.28770	0.29990	0.30290
y	0.30490	0.31630	0.32840	0.31590	y	0.31590	0.32840	0.34420	0.33040
CWA7					CWA8				
x	0.29480	0.29080	0.29830	0.30160	x	0.30160	0.29830	0.30810	0.31050
y	0.27620	0.28590	0.29420	0.28370	y	0.28370	0.29420	0.30510	0.29350
CWB1					CWB2				
x	0.30560	0.30290	0.31160	0.31350	x	0.31350	0.31160	0.32090	0.32190
y	0.31650	0.33040	0.33820	0.32380	y	0.32380	0.33820	0.34650	0.33150



American Opto Plus LED Corp.

L955MWC-ZS

3.5 x 2.8 x 1.9mm White PLCC-2

CWB3					CWB4				
x	0.30810	0.30570	0.31350	0.31520	x	0.31520	0.31350	0.32190	0.32270
y	0.30510	0.31660	0.32380	0.31160	y	0.31160	0.32380	0.33150	0.31870
CWB5					CWB6				
x	0.30290	0.29990	0.30960	0.31160	x	0.31160	0.30960	0.31990	0.32090
y	0.33040	0.34420	0.35260	0.33820	y	0.33820	0.35260	0.36160	0.34650
CWB7					CWB8				
x	0.31050	0.30810	0.31520	0.31680	x	0.31680	0.31520	0.32270	0.32360
y	0.29350	0.30510	0.31160	0.29950	y	0.29950	0.31160	0.31870	0.30580
CWC1					CWC2				
x	0.32190	0.32090	0.33250	0.33240	x	0.33240	0.33250	0.34620	0.34500
y	0.33150	0.34650	0.35650	0.34090	y	0.34090	0.35650	0.36700	0.35150
CWC3					CWC4				
x	0.32270	0.32190	0.33240	0.33240	x	0.33240	0.33240	0.34500	0.34390
y	0.31870	0.33150	0.34090	0.32740	y	0.32740	0.34090	0.35150	0.33730
CWC5					CWC6				
x	0.32090	0.31990	0.33250	0.33250	x	0.33250	0.33250	0.34750	0.34620
y	0.34650	0.36160	0.37210	0.35650	y	0.35650	0.37210	0.38260	0.36700
CWC7					CWC8				
x	0.32360	0.32270	0.33240	0.33230	x	0.33230	0.33240	0.34390	0.34270
y	0.30580	0.31870	0.32740	0.31370	y	0.31370	0.32740	0.33730	0.32260
CWD1					CWD2				
x	0.34500	0.34620	0.36035	0.35805	x	0.35805	0.36035	0.37450	0.37110
y	0.35150	0.36700	0.37680	0.36080	y	0.36080	0.37680	0.38660	0.37010
CWD3					CWD4				
x	0.34390	0.34500	0.35805	0.35600	x	0.35600	0.35805	0.37110	0.36810
y	0.33730	0.35150	0.36080	0.34620	y	0.34620	0.36080	0.37010	0.35510
CWD5					CWD6				
x	0.34620	0.34750	0.36265	0.36035	x	0.36035	0.36265	0.37780	0.37450
y	0.36700	0.38260	0.39260	0.37680	y	0.37680	0.39260	0.40260	0.38660
CWD7					CWD8				
x	0.34270	0.34390	0.35600	0.35375	x	0.35375	0.35600	0.36810	0.36480
y	0.32260	0.33730	0.34620	0.33100	y	0.33100	0.34620	0.35510	0.33940



American Opto Plus LED Corp.

L955MWC-ZS

3.5 x 2.8 x 1.9mm White PLCC-2

CWE1					CWE2				
x	0.37110	0.37450	0.38560	0.38140	x	0.38140	0.38560	0.39940	0.39360
y	0.37010	0.38660	0.39390	0.37680	y	0.37680	0.39390	0.40080	0.38320
CWE3					CWE4				
x	0.36810	0.37110	0.38140	0.37770	x	0.37770	0.38140	0.39360	0.38840
y	0.35510	0.37010	0.37680	0.36190	y	0.36190	0.37680	0.38320	0.36740
CWE5					CWE6				
x	0.37450	0.37780	0.38970	0.38560	x	0.38560	0.38970	0.40500	0.39940
y	0.38660	0.40260	0.41020	0.39390	y	0.39390	0.41020	0.41800	0.40080
CWE7					CWE8				
x	0.36480	0.36810	0.37770	0.37370	x	0.37370	0.37770	0.38840	0.38280
y	0.33940	0.35510	0.36190	0.34580	y	0.34580	0.36190	0.36740	0.35070

Notes:

1. One delivery will include several color ranks and lv ranks of products. The quantity-ratio of the different rank is decided by AOP.
2. Color Coordinates Measurement Allowance is ± 0.01 .



American Opto Plus LED Corp.

L955MWC-ZS

3.5 x 2.8 x 1.9mm White PLCC-2

OPTICAL CHARACTERISTIC CURVES:

Forward Current vs. Forward Voltage

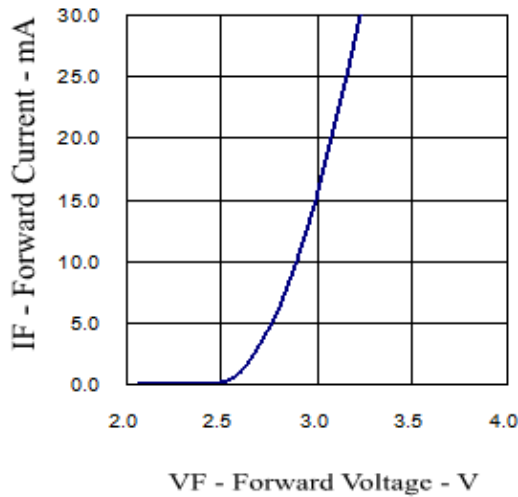

Relative Intensity vs. Forward Current

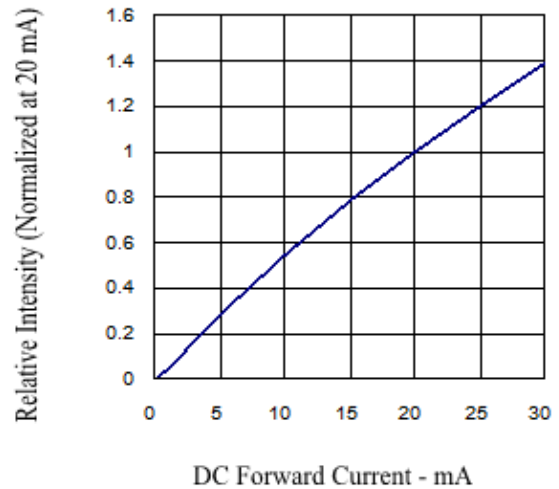

Forward Current vs. Ambient Temperature

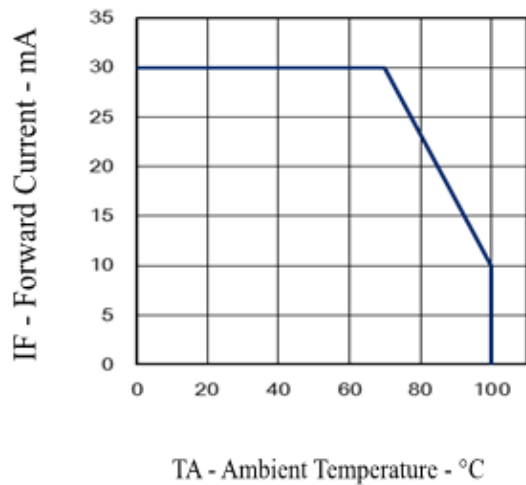

Relative Intensity vs. Wavelength

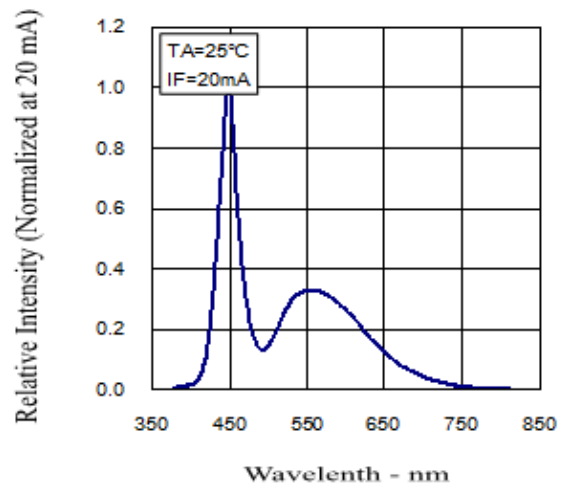



American Opto Plus LED Corp.

L955MWC-ZS

3.5 x 2.8 x 1.9mm White PLCC-2

RADIATION PATTERN

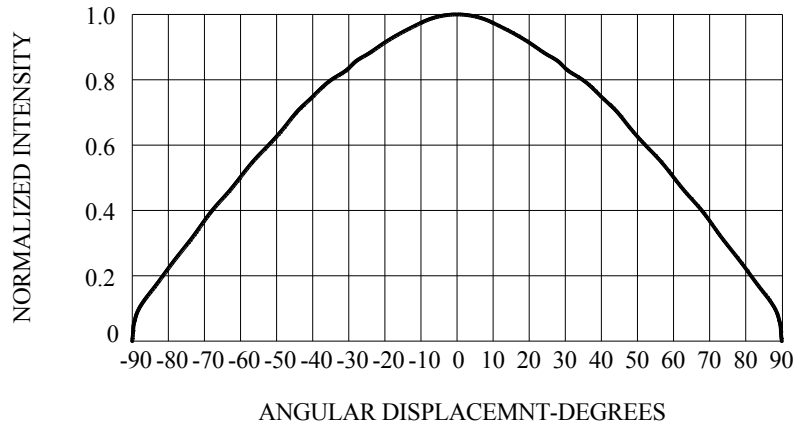

RECOMMENDED SOLDERING PAD PATTERN

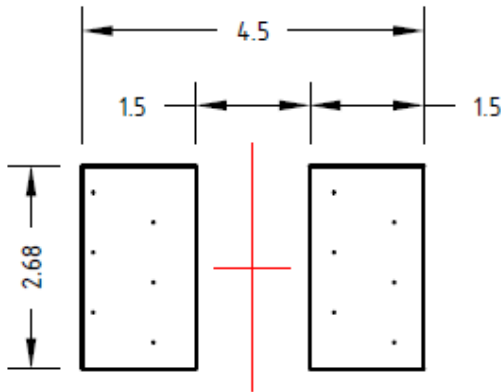

(Unit:mm)

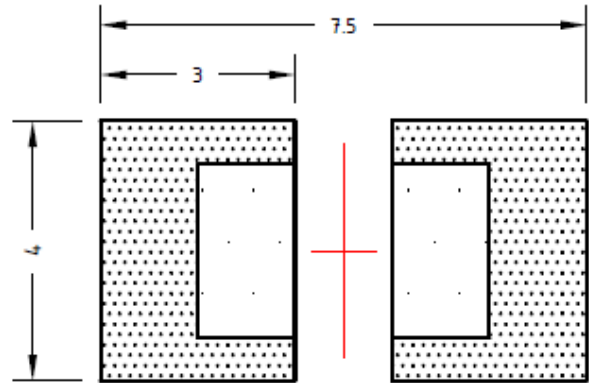

 Solder resist (Unit:mm)



American Opto Plus LED Corp.

L955MWC-ZS

3.5 x 2.8 x 1.9mm White PLCC-2

SOLDERING CONDITIONS:

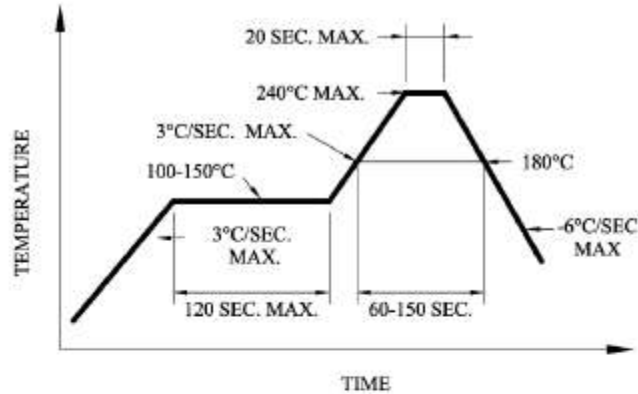

Recommended reflow soldering profile

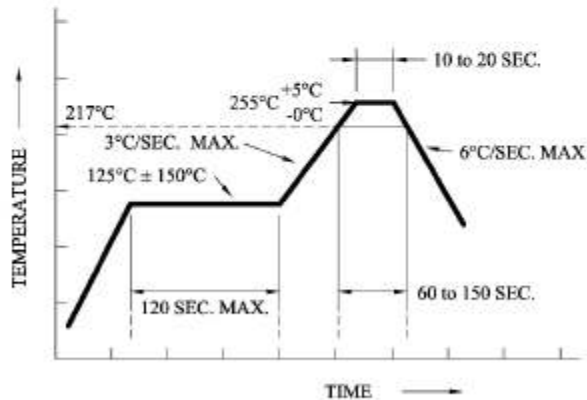

Recommended Pb-free reflow soldering profile.

- Repairing should not be done after the LEDs have been soldered. When repairing is unavoidable, a double-head soldering iron should be used. It should be confirmed beforehand whether the characteristics of the LEDs will or will not be damaged by repairing.
- Reflow soldering should not be done more than two times.
- When soldering, do not put stress on the LEDs during heating.
- After soldering, do not warp the circuit board.



American Opto Plus LED Corp.

L955MWC-ZS

3.5 x 2.8 x 1.9mm White PLCC-2

TAPE DIMENSION

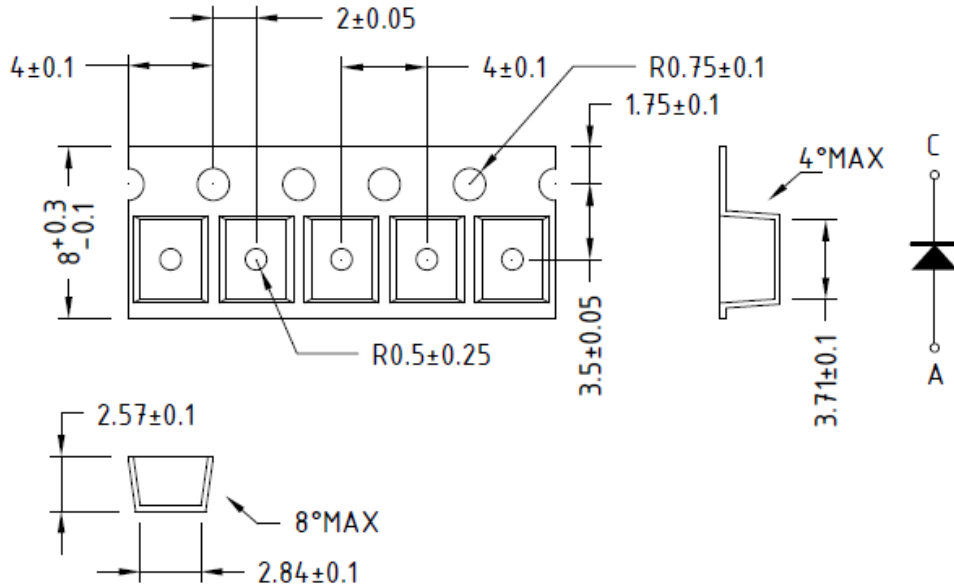

TAPE LEADER AND TRAILER DIMENSION

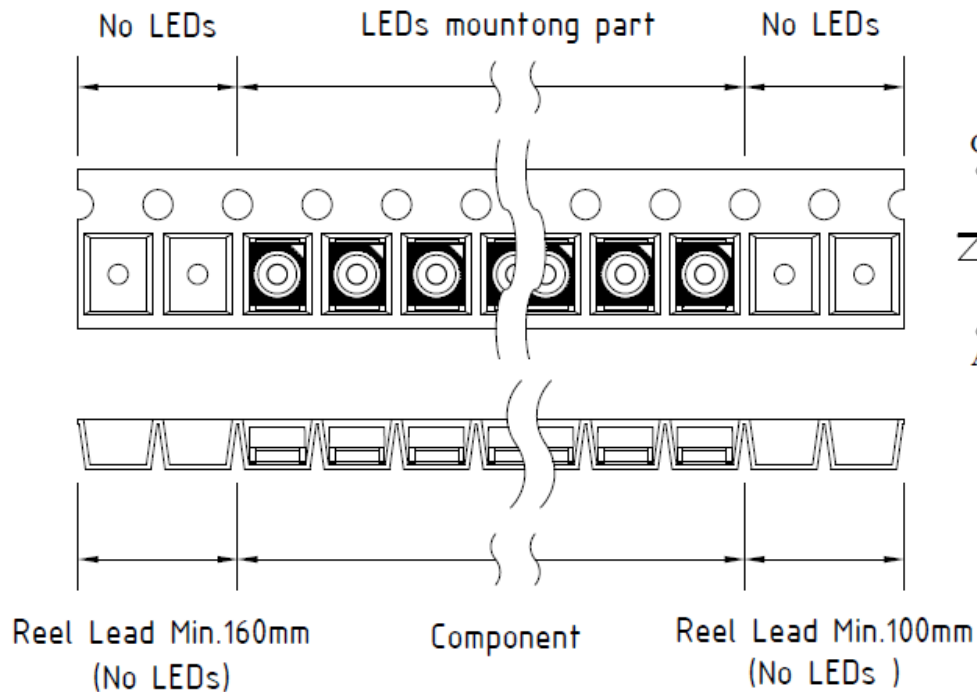

USER FEED DIRECTION



American Opto Plus LED Corp.

L955MWC-ZS

3.5 x 2.8 x 1.9mm White PLCC-2

REEL DIMENSION

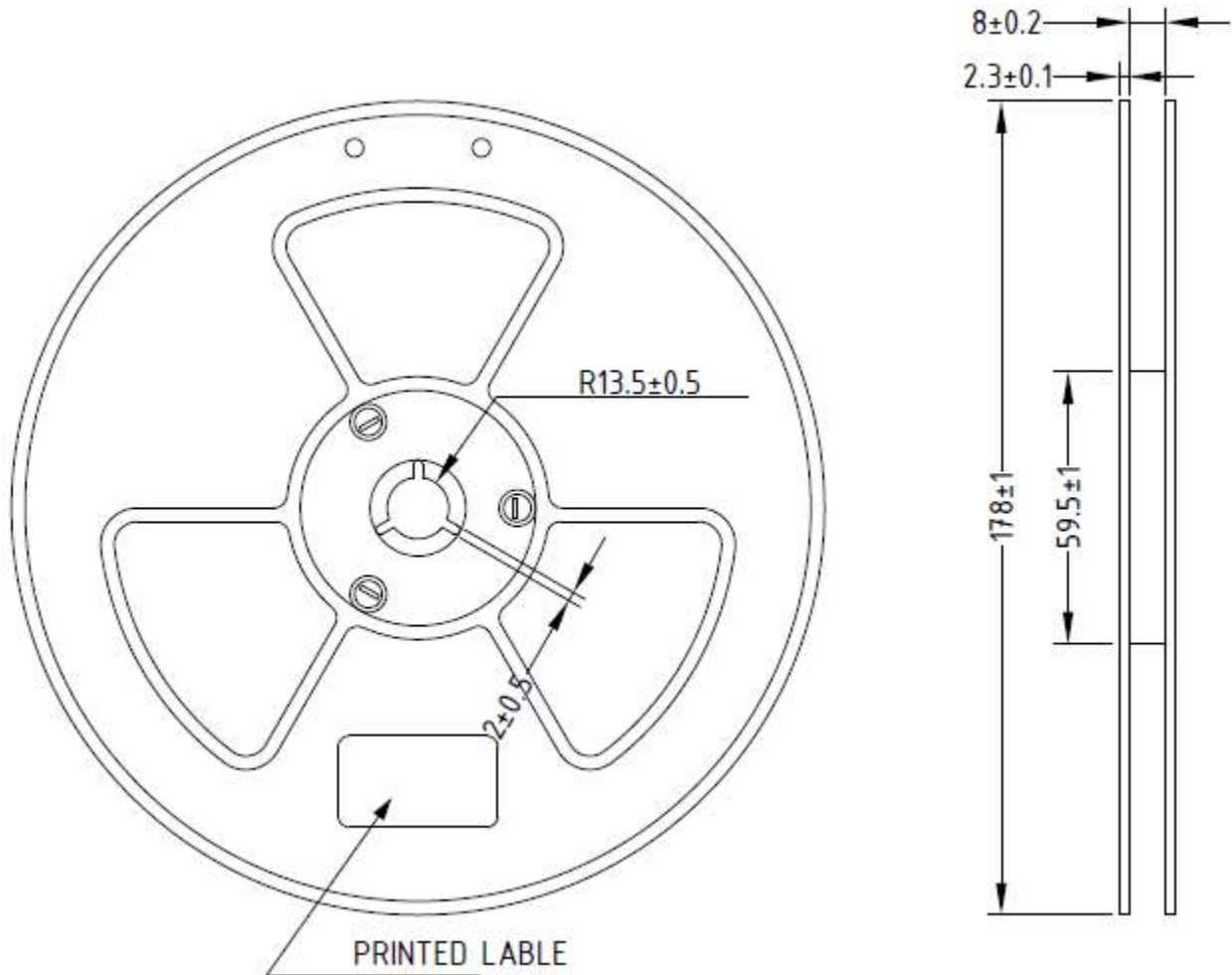

Notes:

1. Baking is required when the pack has been opened for more than four weeks. Baking recommended conditions: 60 ± 5 °C for 20 hours.
2. Available in 8mm carrier tape on 7 inch reel (2000 pieces).



American Opto Plus LED Corp.

L955MWC-ZS

3.5 x 2.8 x 1.9mm White PLCC-2

Moisture Sensitivity

AOP's SMD LED are shipped in sealed, moisture-barrier bags (MBB) designed for long shelf life.

If SMD LED has exposed with moist environments before soldering, this may cause damage to SMD LED during soldering (reflow) operation.

Storage / Floor Time

Condition	Temperature(C)	Humidity(RH)	Period of Time
Before Open	30	60	1 year from shipping date
After Open	30	60	Within 72 hours

- MSL of this product are MSL4, please see IPC/JEDEC STD020D for more detail.
- LEDs reach floor time may be damaged while soldering/reflow processing, please baking the LEDs before use.
- If RH indicator card show 60%RH when unseal the package, please bake/discard the LED.

Reseal

- AOP's aluminum MBB may reuse as to reseal the unused LED if MBB has not damaged or had any holes on it.
- Moisture absorbent material(Silica gel) may be reuse if it does not become pink.
- Proper resealed LED's Floor time will NOT RESET, only stop counting until open.
- If RH indicator card show 60%RH when open the package, please bake/discard the LED.

Baking

Condition	Temperature(C)	Period of Time
With Reel	60	More than 24 hours, but not more than 48 hours
Without Reel	90	24 hours

- Baking of LED available ONCE only, more than once may damage the LEDs while baking.
- Baking only required when LED reach it's floor time.