

ONE PHASE POWER DISTRIBUTION BLOCKS

- Quick mounting and wiring
- IP20 Finger Safe
- DIN Rail or Panel Mount
- Blocks fit with other DIN Rail mountable modular devices (height 95mm, depth 44.5mm)
- Accessories increase the number of outputs with only one input (applies **only** to 38041 and 38032)
- No caps to open or remove
- Material
 - Housing: Polyamide
 - Metal Body: Brass

38049



38041



SCCR: 100kA

SCCR: 100kA

Part Number:

White **38049** (UL File E98082)

White **38041** (UL File E98082)

Gray **DB16** (UL File E220514)

Gray **DB35** (UL File E220514)

Approvals



Current Rating

80A

80A

115A

125A

Voltage Rating

600V AC

690V AC

600V AC

690V AC

No. of Inputs

1

1

1

1

Wire Range

8-4 AWG

6-16mm²

8-2 AWG

10-35mm²

Torque

13.5lb.-in.

1.5Nm

31lb.-in.

40lb.-in.
for DB35

3.5Nm

Screw Type

Pozi Drive 2

Pozi Drive 2

No. of Outputs

6

6

6

6

Wire Range

(2x)8-4 AWG

(2x)6-16mm²

14-4 AWG

2.5-16mm²

Torque

13.5lb.-in.

1.5Nm

17.5lb.-in.

2Nm

Wire Range

(4x)14-10 AWG

(4x)2.5-6mm²

Screw Type

Pozi Drive 2

Pozi Drive 2

Optional

Marking Tag

MT2*

MT2*

*(for DB16 and DB35)

Dimensions:

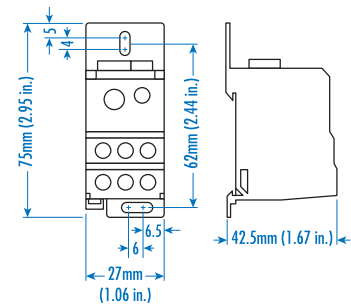
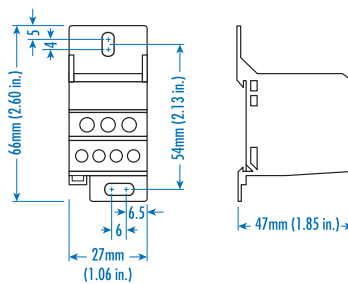

38041

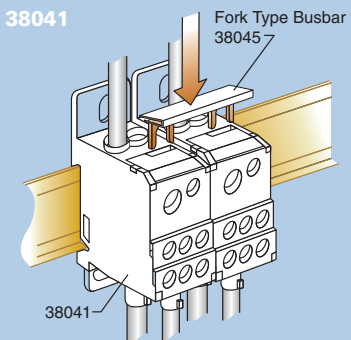

Accessories: Fork Type Busbar

Part No: **38045** to jump 2 Blocks

38046 to jump 8 Blocks

can be cut

38076



38032



38074



SCCR: 100kA

SCCR: 100kA

SCCR: 100kA

Part Number:	38076		38032		38074	
Approvals	 UL File E98082		 UL File E98082		 UL File E98082	
Current Rating	115A	125A	160A	160A	175A	175A
Voltage Rating	600V AC	690V AC	600V AC	690V AC	600V AC	690V AC
No. of Inputs	1	1	1	1	1	1
Wire Range	8-2 AWG	10-35mm ²	8-2/0AWG	10-70mm ²	6-2/0AWG	16-70mm ²
Torque	53lb.-in.	6Nm	35.5lb.-in.	4Nm	53lb.-in.	6Nm
Screw Type	Hex 4		Hex 5		Hex 5	
No. of Outputs	10	10	6	6	10	10
Wire Range	14-4 AWG	2.5-16mm ²	14-6 AWG	2.5-16mm ²	14-4 AWG	2.5-16mm ²
Torque	26.5lb.-in.	3Nm	17.5lb.-in.	2Nm	26.5lb.-in.	3Nm
Screw Type	Hex 3		Hex 3		Hex 3	

Dimensions:

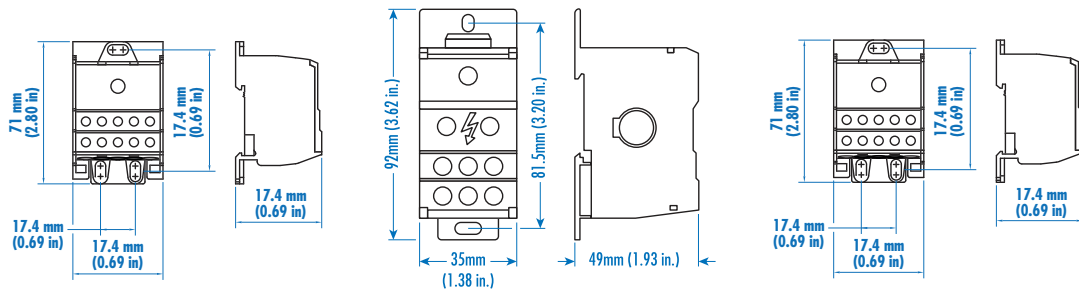

38032

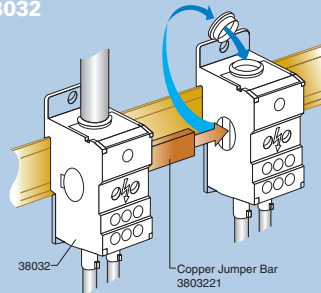

Accessories: Copper Jumper Bar (6x15 mm)

Part No: **3803221** for 2 Blocks
3803231 for 3 Blocks
3803241 for 4 Blocks
 can be cut

ONE PHASE POWER DISTRIBUTION BLOCKS

- Quick mounting and wiring
- IP20 Finger Safe
- DIN Rail or Panel Mount
- Blocks fit with other DIN Rail mountable modular devices (height 95mm, depth 44.5mm)
- Accessories increase the number of outputs with only one input.
- No caps to open or remove
- Material
 - Housing: Polyamide
 - Metal Body: Brass

38020









38019



SCCR: 100kA

SCCR: 100kA

Part Number:	38020		38019	
Approvals	   UL File E98082 C US		   UL File E98082 C US	
Current Rating	230A	250A	310A	400A
Voltage Rating	600V AC 690V AC		600V AC 690V AC	
No. of Inputs	1	1	1	1
Wire Range	2-4/0AWG	35-120mm ²	3/0-350kcmil	95-185mm ²
Torque	170lb.-in.	19Nm	230lb.-in.	25Nm
Screw Type	Hex 6		Hex 8	
No. of Outputs	11	11	11	11
Wire Range	(2x) 14-2AWG	(2x) 2.5-35mm ²	(2x) 14-2AWG	(2x) 2.5-35mm ²
Torque	31lb.-in.	3.5Nm	31lb.-in.	3.5Nm
Wire Range	(5x) 14-6AWG	(5x) 2.5-16mm ²	(5x) 14-6AWG	(5x) 2.5-16mm ²
Torque	17.5lb.-in.	2Nm	17.5lb.-in.	2Nm
Wire Range	(4x) 14-8AWG	(4x) 2.5-10mm ²	(4x) 14-8AWG	(4x) 2.5-10mm ²
Torque	17.5lb.-in.	2Nm	17.5lb.-in.	2Nm
Screw Type	standard screwdriver		standard screwdriver	

Dimensions:

