

MEMS Flow Sensors

D6F

Series Catalog

Faster and more accurate than ever before ———

MEMS flow sensor : the ideal means for mass flow measurement

Omron flow sensor
so precise
even the flap of a butterfly's
wings will not be missed.



Realizing a highly accurate flow measurement,

Omron's MEMS flow sensor accurately detects minute airflow so much as a single flap of a butterfly's wings. A gas flow sensor is capable of "measuring mass flow" independent of temperature and pressure.



D6F-A6



D6F-W



Q&A on Mass Flow Measurement

Q1 There are two balloons; each having different volumes. But these balloons have the same mass. Why is that?

A The volume increases/decreases according to the pressure and temperature changes. The mass, on the other hand, remains constant regardless of the environmental changes. The mass flow measurement allows measurement performance that is not affected by changes in the environment.

Q2 Why is mass flow measurement required?

A An accurate measurement of the flow is required especially for combustion control. Omron's flow sensor enables measuring the gas flow based on the mass flow measurement.

Principles of MEMS Flow D6F Series

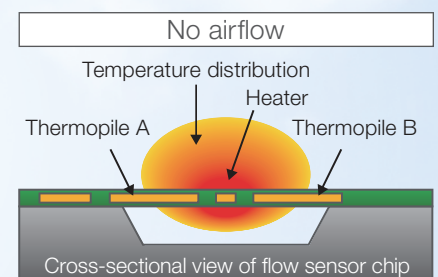

During the absence of airflow, the temperature distribution around the heater is symmetrical. When there is airflow, the temperature of the upwind side cools down and the temperature of the downwind side warms up, disrupting the symmetry of the temperature distribution.

sensing even a single flap of a butterfly's wings



High Accuracy

±3%RD (25-100%F.S.) is realized by linear temperature correction using ASIC technology

Ambient temperature = 25degC (Model: D6F-20A7D-000-0)

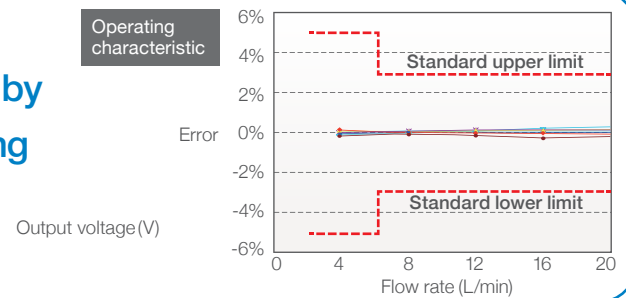

High Sensitivity

Omron's unique MEMS technology allows detection of very low air velocities

Flow rate of 1L: Output corresponding to flow rate change below 1/1000 of full scale.

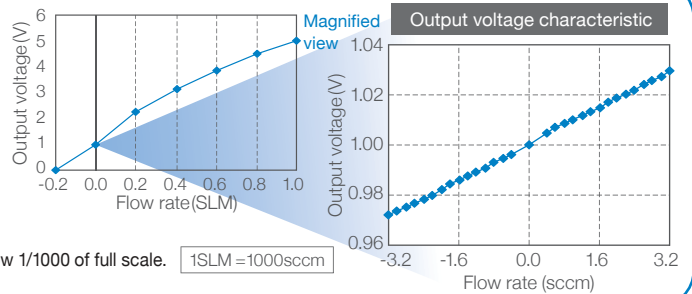

Compact

The product size is reduced by using the world-smallest class size MEMS sensor element

Dimension of D6F-V model: 24x8x14mm.



Sensor Measurement

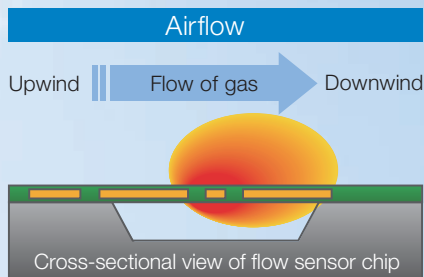

By detecting this temperature difference appearing as a difference in the electromotive forces developed by the thermopiles, it allows the mass flow rate and mass flow velocity to be measured without the influence of temperature and pressure. Since the thermopile generates the thermo-electromotive force, the power consumption is much lower than when using the resistivity method.

Highly Resistant to Dust

Patent No.4534526

Built-in Dust Segregation System (cyclonic) D6F-W/-V/-P

The sensor can be placed anywhere thanks to its dust-resistant structure. Omron's unique design of 3D flow path provides a high level of reliability by separating dust particles to reduce its effect on the sensor chip. Additionally, Omron succeeded in reducing the sensor size, allowing it to be used in wider range of applications.

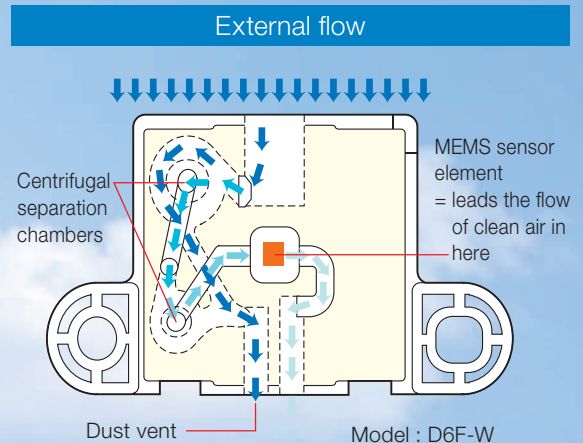
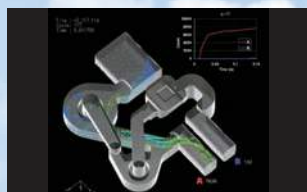

Applications

Omron flow sensors cover a wide range of applications and can be used for different purposes.

Application Examples

Combustion

For optimal control of the amount of gas by measuring the mass flow rate

- ▶ Flow rate
- ▶ Differential pressure



Fuel cell



Boiler



Welder

Optimizing combustion efficiency

HVAC

For feedback control of air conditioning by measuring the amount of air and amount of ventilation

- ▶ Velocity
- ▶ Differential pressure



Ventilation system

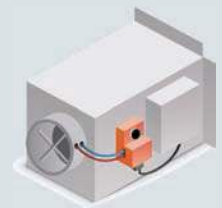

VAV (central air conditioning)

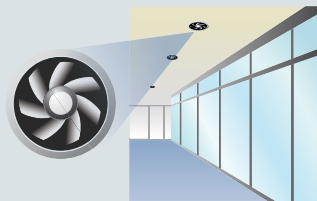

Fans

Controlling the amount of air at the required level and monitoring the amount of ventilation

Measurement

For optimal control of pumps by measuring the flow rate
For management of positive pressure and negative pressure by measuring the differential pressure

- ▶ Flow rate
- ▶ Differential pressure



Gas detector



Gas analyzer



Low differential pressure transmission

Accurately detecting gas concentrations
Monitoring the positive/negative pressure in a room

Clogging Detection

For monitoring the flow of the cooling air to optimize the cooling efficiency and avoid malfunctions.

- ▶ Flow rate
- ▶ Velocity
- ▶ Differential pressure



Projector



Industrial air conditioner

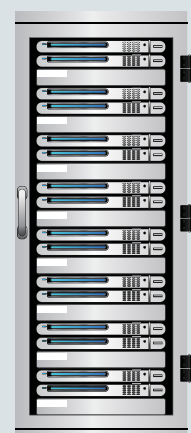

Server

Quiet, low maintenance cost

Selection of Products

Select the most suitable sensor from many variations.

Flow Rate

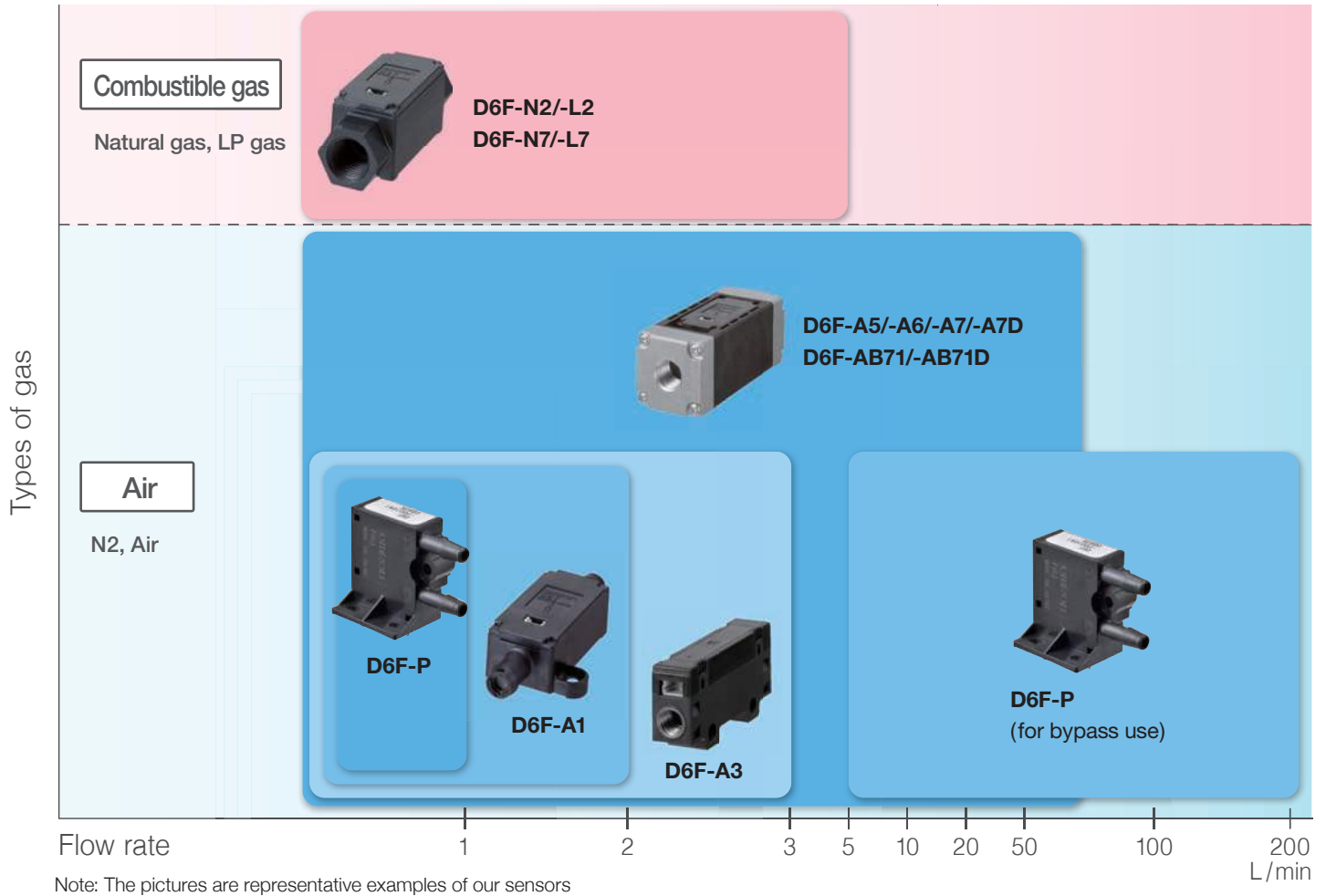

Flow Velocity

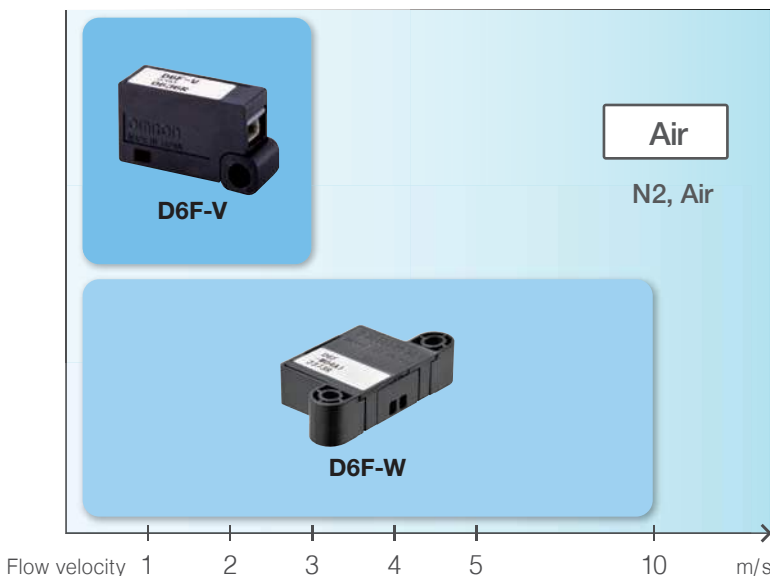

Differential Pressure

Delivers high sensitivity even at low flow rate, low differential pressure

MEMS differential pressure sensor

High precision
Accurate measurement

Low piping effects

High impedance to reduce the influence of piping variations

High reliability





Detect sensor anomaly





List of D6F series

MEMS Flow Sensor









Air Minute flow Analog

Applicable gas		Air			
Items	Model	D6F-P0001A1	D6F-01A1-110 D6F-P0010A□ D6F-P0010AM2	D6F-02A1-110	D6F-03A3-000
Shape					
Flow rate range (L/min)	5				0~3L/min
	4				
	3				
	2	0~0.1L/min	0~1L/min	0~2L/min	
	1				
	0				
Page		25	8, 25	8	12

Gas Minute to middle flow Analog





Applicable gas		Natural gas (13A)	LP gas	Natural gas (13A)
Items	Model	D6F-01N2-000	D6F-02L2-000 D6F-02L7-000	D6F-05N2-000 D6F-05N7-000
Shape				
Flow rate range (L/min)	5			0~5L/min
	4			
	3			
	2	0~1L/min	0~2L/min	
	1			
	0			
Page		10	10, 18	10, 16, 18

Air Middle to high flow Analog Digital Digital type only

Applicable gas		Air				
Items	Model	D6F-10A5-000 D6F-10A6-000 D6F-10A7-000 D6F-10A7D-000 	D6F-20A5-000 D6F-20A6-000 D6F-20A7D-000 	D6F-30A7-000 D6F-30AB71-000	D6F-50A5-000 D6F-50A6-000 D6F-50A7D-000 	D6F-70AB71-000 D6F-70AB71D-000 
Shape						
Flow rate range (L/min)	70				0~50L/min	0~70L/min
	60					
	50					
	40			0~30L/min		
	30	0~10L/min	0~20L/min			
	0					
Page		14, 16, 18, 20	14, 16, 20	18, 23	14, 16, 20	20, 23













MEMS Flow Sensor

Air
 Flow velocity
 Analog

Applicable gas		Air			
Items	Model	D6F-W01A1	D6F-V03A1	D6F-W04A1	D6F-W10A1
Shape					
Flow velocity range (m/s)	10				0~10m/s
	8				
	6				
	4		0~3m/s	0~4m/s	
	2	0~1m/s			
	-2				
Page		34	36	34	34

MEMS Differential Pressure Sensor

Air
 Differential pressure
 Digital
 Digital type only

Applicable gas		Air		
Items	Model	D6F-PH0505AD3  D6F-PH0505AD4  D6F-PH0505AMD4 	D6F-PH0025AD1  D6F-PH0025AD2  D6F-PH0025AMD2 	D6F-PH5050AD3  D6F-PH5050AD4  D6F-PH5050AMD4 
Shape				
Differential pressure range (Pa)	500			-500~500Pa
	250		0~250Pa	
	50	-50~50Pa		
	0			
	-50			
	-500			
Page		28		

D6F-A1

MEMS Flow Sensor

A Compact, High-Accuracy Sensor That Measures Low Flow Rates.

- High accuracy of $\pm 3\%$ FS.
- Flow rates can be measured without being affected by temperature or pressure.



RoHS Compliant



Refer to the *Common Precautions for the D6F Series* on page 39.

Ordering Information

MEMS Flow Sensor

Applicable fluid	Flow rate range	Model
Air	0 to 1 L/min	D6F-01A1-110
	0 to 2 L/min	D6F-02A1-110

Accessory (included)

Type	Model
Cable	D6F-CABLE1

Connections

D6F-01A1-110 D6F-02A1-110

Pin No. 1: Vcc
 2: Vout
 3: GND

Connector 53398-03** (Made by Molex Japan)

Use the following connectors for connections to the D6F:
 Housing 51021-0300 (Made by Molex Japan)
 Terminals 50079 (Made by Molex Japan)
 Wires AWG28 to AWG26

Tubes Install tubes made of materials such as rubber or urethane so that they will not come out.
 For urethane tubes, tubes with an outer diameter of 12 mm and an inner diameter of 8 mm are recommended.

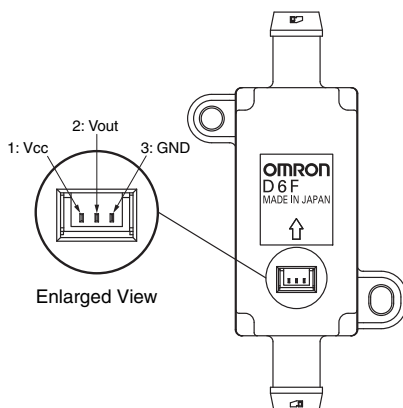

Output Voltage Characteristics

D6F-01A1-110

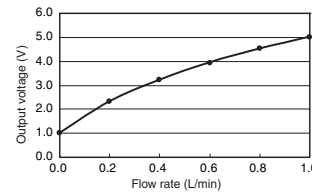

D6F-02A1-110

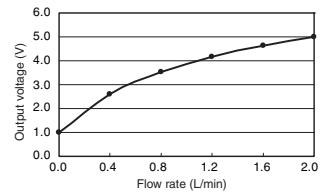

D6F-01A1-110

Flow rate L/min (normal)	0	0.2	0.4	0.6	0.8	1.0
Output voltage V	1.00	2.31	3.21	3.93	4.51	5.00
	± 0.12	± 0.12	± 0.12	± 0.12	± 0.12	± 0.12

D6F-02A1-110

Flow rate L/min (normal)	0	0.4	0.8	1.2	1.6	2.0
Output voltage V	1.00	2.59	3.53	4.18	4.65	5.00
	± 0.12	± 0.12	± 0.12	± 0.12	± 0.12	± 0.12

Measurement conditions: Power supply voltage of 12 ± 0.1 VDC, ambient temperature of $25 \pm 5^\circ\text{C}$, and ambient humidity of 35% to 75%.

Characteristics/Performance

Model	D6F-01A1-110	D6F-02A1-110
Flow Range (See note 1.)	0 to 1 L/min	0 to 2 L/min
Calibration Gas (See note 2.)	Air	
Flow Port Type	Bamboo joint Maximum outside diameter: 8.6 mm, Minimum outside diameter: 7.4 mm	
Electrical Connection	Three-pin connector	
Power Supply	10.8 to 26.4 VDC	
Current Consumption	15 mA max with no load, with a Vcc of 12 to 24 VDC, and at 25°C	
Output Voltage	1 to 5 VDC (non-linear output, load resistance of 10 kΩ)	
Accuracy	±3% FS (25°C characteristic)	
Repeatability (See note 3.)	±0.3% FS	
Output Voltage (Max.)	5.7 VDC (Load resistance: 10 kΩ)	
Output Voltage (Min.)	0 VDC (Load resistance: 10 kΩ)	
Rated Power Supply Voltage	26.4 VDC	
Rated Output Voltage	6 VDC	
Case	PPS	
Degree of Protection	IEC IP40 (Excluding tubing sections.)	
Withstand Pressure	200 kPa	
Pressure Drop (See note 3.)	0.42 kPa	1.06 kPa
Operating Temperature (See note 4.)	-10 to 60°C	
Operating Humidity (See note 4.)	35% to 85%	
Storage Temperature (See note 4.)	-40 to 80°C	
Storage Humidity (See note 4.)	35% to 85%	
Temperature Characteristics	±3% FS for 25°C characteristic at an ambient temperature of -10 to 60°C	
Insulation Resistance	Between sensor outer cover and lead terminals: 20 MΩ min. (at 500 VDC)	
Dielectric Strength	Between sensor outer cover and lead terminals: 500 VAC, 50/60 Hz min. for 1 min (leakage current: 1 mA max.)	
Weight	12.8 g	

Note: 1. Volumetric flow rate at 0°C, 101.3 kPa.

Note: 2. Dry gas. (must not contain large particles, e.g., dust, oil, or mist.)

Note: 3. Reference (typical)

Note: 4. With no condensation or icing.

Dimensions

[CAD Data](#) Please visit our CAD Data website, which is noted on the last page.

(Unit: mm)

D6F-01A1-110 D6F-02A1-110

[CAD Data](#)

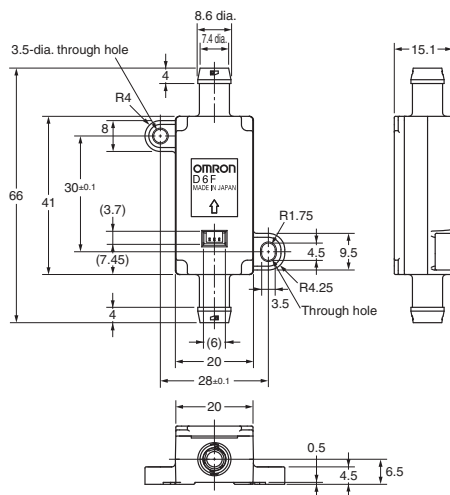

Mounting Hole Dimensions

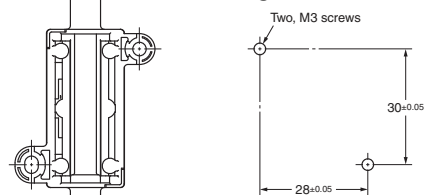

Cable (included): D6F-CABLE1

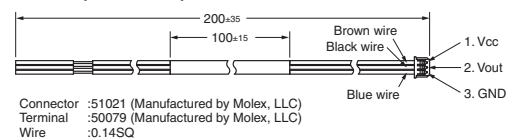

D6F-N2/-L2

MEMS Flow Sensor

A Compact, High-Accuracy Sensor That Measures Low Flow Rates.

- High accuracy of $\pm 3\%$ FS.
- Flow rates can be measured without being affected by temperature or pressure.

Gas Analog



RoHS Compliant



Refer to the *Common Precautions for the D6F Series* on page 39.

Ordering Information

MEMS Flow Sensor

Applicable fluid	Flow rate range	Model
Natural gas (13A)	0 to 1 L/min	D6F-01N2-000
	0 to 5 L/min	D6F-05N2-000
LP gas	0 to 2 L/min	D6F-02L2-000

Accessory (included)

Type	Model
Cable	D6F-CABLE1

Connections

D6F-01N2-000

D6F-05N2-000

D6F-02L2-000

Pin No. 1: Vcc
2: Vout
3: GND

Connector 53398-03** (Made by Molex Japan)

Use the following connectors for connections to the D6F:

Housing 51021-0300 (Made by Molex Japan)

Terminals 50079 (Made by Molex Japan)

Wires AWG28 to AWG26

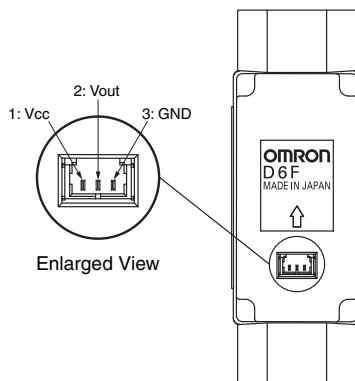

Output Voltage Characteristics

D6F-01N2-000

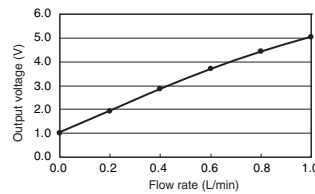

D6F-05N2-000

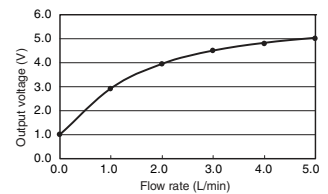

D6F-02L2-000

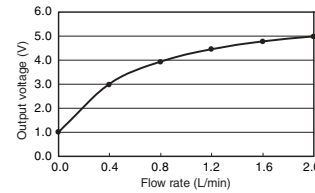

D6F-01N2-000

Flow rate L/min (normal)	0	0.2	0.4	0.6	0.8	1.0
Output voltage V	1.00 ± 0.12	1.90 ± 0.12	2.81 ± 0.12	3.64 ± 0.12	4.37 ± 0.12	5.00 ± 0.12

D6F-05N2-000

Flow rate L/min (normal)	0	1.0	2.0	3.0	4.0	5.0
Output voltage V	1.00 ± 0.12	2.91 ± 0.12	3.92 ± 0.12	4.47 ± 0.12	4.79 ± 0.12	5.00 ± 0.12

D6F-02L2-000

Flow rate L/min (normal)	0	0.4	0.8	1.2	1.6	2.0
Output voltage V	1.00 ± 0.30	3.02 ± 0.08	3.95 ± 0.08	4.47 ± 0.08	4.79 ± 0.08	5.00 ± 0.12

Measurement conditions: Power supply voltage of 12 ± 0.1 VDC, ambient temperature of $25 \pm 5^\circ\text{C}$, and ambient humidity of 35% to 75%.

Characteristics/Performance

Model	D6F-01N2-000	D6F-05N2-000	D6F-02L2-000
Flow Range (See note 1.)	0 to 1 L/min	0 to 5 L/min	0 to 2 L/min
Calibration Gas (See note 2.)	Natural gas (13A)		Propane gas
Flow Port Type	Rc 1/4 thread		
Electrical Connection	Three-pin connector		
Power Supply	10.8 to 26.4 VDC		
Current Consumption	15 mA max. with no load, with a Vcc of 12 to 24 VDC, and at 25°C		
Output Voltage	1 to 5 VDC (non-linear output, load resistance of 10 kΩ)		
Accuracy	±3% FS (25°C characteristic)	±2% to ±7.5% F.S. (25°C characteristic)	
Repeatability (See note 3.)	±0.2% FS	±0.3% FS	
Output Voltage (Max.)	5.7 VDC (Load resistance: 10 kΩ)		
Output Voltage (Min.)	0 VDC (Load resistance: 10 kΩ)		
Rated Power Supply Voltage	26.4 VDC		
Rated Output Voltage	6 VDC		
Case	Aluminum alloy		
Degree of Protection	IEC IP40 (Excluding tubing sections.)		
Withstand Pressure	200 kPa		
Pressure Drop (See note 3.)	0.017 kPa	0.10 kPa	0.14 kPa
Operating Temperature (See note 4.)	-10 to 60°C		
Operating Humidity (See note 4.)	35% to 85%		
Storage Temperature (See note 4.)	-40 to 80°C		
Storage Humidity (See note 4.)	35% to 85%		
Temperature Characteristics	±3% FS for 25°C characteristic at -10 to 60°C	±4% FS for 25°C characteristic at -10 to 60°C	
Insulation Resistance	Between sensor outer cover and lead terminals: 20 MΩ min. (at 500 VDC)		
Dielectric Strength	Between sensor outer cover and lead terminals: 500 VAC, 50/60 Hz min. for 1 min (leakage current: 1 mA max.)		
Weight	35.3 g		

Note: 1. Volumetric flow rate at 0°C, 101.3 kPa.

Note: 2. Dry gas. (must not contain large particles, e.g., dust, oil, or mist.)

Note: 3. Reference (typical)

Note: 4. With no condensation or icing.

Dimensions

CAD Data Please visit our CAD Data website, which is noted on the last page.

(Unit: mm)

D6F-01N2-000
D6F-05N2-000
D6F-02L2-000

CAD Data

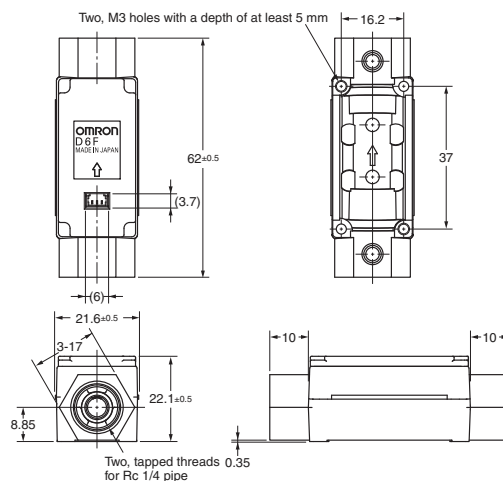

Mounting Hole Dimensions

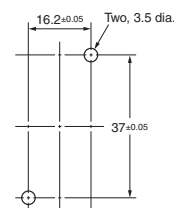

Cable (included): D6F-CABLE1

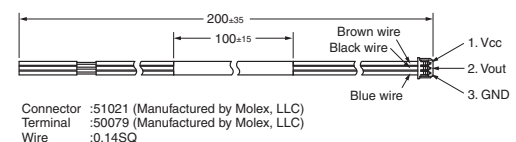

D6F-A3

MEMS Flow Sensor

High-Accuracy Sensing with a Thin, Compact Body.

- A thin, lightweight flow sensor.
- Unique flow path structure provides high precision and fast response.

Air Analog



RoHS Compliant



Refer to the *Common Precautions for the D6F Series* on page 39.

Ordering Information

MEMS Flow Sensor

Applicable fluid	Flow rate range	Model
Air	0 to 3 L/min	D6F-03A3-000

Accessory (Sold separately)

Type	Model
Cable	D6F-CABLE2
	D6F-CABLE2-L

Note: Refer to *Accessories for the D6F Series* on page 38.

Connections

D6F-03A3-000

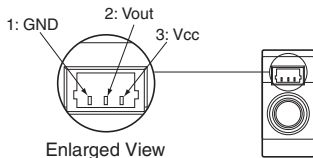

Pin No. 1: GND
2: Vout
3: Vcc

Connector SM03B-SRSS-TB (Made by J.S.T. Mfg. Co.)

Use the following connectors made by J.S.T. Mfg. Co. for connections to the Sensor:

- Pressure-welded Connector
Socket: 03SR-3S
Wires: AWG30
Or
- Crimp Connector
Contacts: SSH-003T-P0.2
Housing: SHR-03V-S or SHR-03V-S-B
Wires: AWG32 to AWG28

Output Voltage Characteristics

D6F-03A3-000

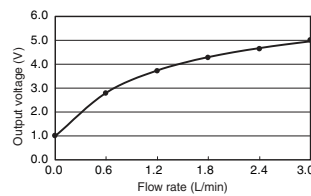

D6F-03A3-000

Flow rate L/min (normal)	0	0.6	1.2	1.8	2.4	3.0
Output voltage V	1.00 ±0.2	2.83 ±0.2	3.77 ±0.2	4.34 ±0.2	4.72 ±0.2	5.00 ±0.2

Measurement conditions: Power supply voltage of 12 ± 0.1 VDC, ambient temperature of $25 \pm 5^\circ\text{C}$, and ambient humidity of 35% to 75%.

D6F-A5

MEMS Flow Sensor

High-Accuracy Sensing with a Compact Body for Flow Rates Up to 50 L/min.

Air Analog

- Accurately detects a mass flow rate of 10 to 50 L/min.
- A compact size of 30 × 78 × 30 mm (H × W × D).



RoHS Compliant



Refer to the *Common Precautions for the D6F Series* on page 39.

Ordering Information

MEMS Flow Sensor

Flow Port Type	Applicable fluid	Flow rate range	Model
Manifold	Air	0 to 10 L/min	D6F-10A5-000
		0 to 20 L/min	D6F-20A5-000
		0 to 50 L/min	D6F-50A5-000

Accessory (Sold separately)

Type	Model
Cable	D6F-CABLE1

Note: Refer to *Accessories for the D6F Series* on page 38.

Connections

D6F-10A5-000
D6F-20A5-000
D6F-50A5-000

Pin No. 1: Vcc
2: Vout
3: GND
Connector 53398-03** (Made by Molex Japan)

Use the following connectors for connections to the D6F:
Housing 51021-0300 (Made by Molex Japan)
Terminals 50079 (Made by Molex Japan)
Wires AWG28 to AWG26

1: Vcc 2: Vout 3: GND

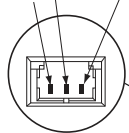

Enlarged View



Output Voltage Characteristics

D6F-10A5-000

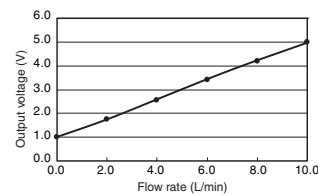

D6F-20A5-000

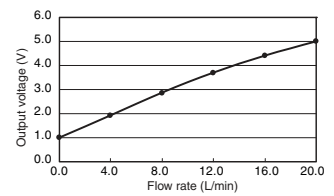

D6F-50A5-000

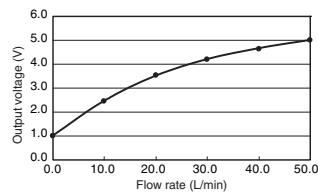

D6F-10A5-000

Flow rate L/min (normal)	0	2.0	4.0	6.0	8.0	10.0
Output voltage V	1.00 ±0.12	1.75 ±0.12	2.60 ±0.12	3.45 ±0.12	4.25 ±0.12	5.00 ±0.12

D6F-20A5-000

Flow rate L/min (normal)	0	4.0	8.0	12.0	16.0	20.0
Output voltage V	1.00 ±0.12	1.93 ±0.12	2.87 ±0.12	3.70 ±0.12	4.41 ±0.12	5.00 ±0.12

D6F-50A5-000

Flow rate L/min (normal)	0	10	20	30	40	50
Output voltage V	1.00 ±0.12	2.45 ±0.12	3.51 ±0.12	4.20 ±0.12	4.66 ±0.12	5.00 ±0.12

Measurement conditions: Power supply voltage of 12±0.1 VDC, ambient temperature of 25±5°C, and ambient humidity of 35% to 75%.

Characteristics/Performance

Model	D6F-10A5-000	D6F-20A5-000	D6F-50A5-000
Flow Range (See note 1.)	0 to 10 L/min	0 to 20 L/min	0 to 50 L/min
Calibration Gas (See note 2.)	Air		
Flow Port Type	Manifold		
Electrical Connection	Three-pin connector		
Power Supply	10.8 to 26.4 VDC		
Current Consumption	15 mA max. with no load, with a Vcc of 12 to 24 VDC, and at 25°C		
Output Voltage	1 to 5 VDC (non-linear output, load resistance of 10 kΩ)		
Accuracy	±3% FS (25°C characteristic)		
Repeatability (See note 3.)	±0.3% FS		
Output Voltage (Max.)	5.7 VDC (Load resistance: 10 kΩ)		
Output Voltage (Min.)	0 VDC (Load resistance: 10 kΩ)		
Rated Power Supply Voltage	26.4 VDC		
Rated Output Voltage	6 VDC		
Case	PPS/aluminum alloy		
Degree of Protection	IEC IP40 (Excluding tubing sections.)		
Withstand Pressure	500 kPa		
Pressure Drop (See note 3.)	0.8 kPa	2.9 kPa	17.2 kPa
Operating Temperature (See note 4.)	-10 to 60°C		
Operating Humidity (See note 4.)	35% to 85%		
Storage Temperature (See note 4.)	-30 to 80°C		
Storage Humidity (See note 4.)	35% to 85%		
Temperature Characteristics	±3% FS for 25°C characteristic at an ambient temperature of -10 to 60°C		
Insulation Resistance	Between sensor outer cover and lead terminals: 20 MΩ min. (at 500 VDC)		
Dielectric Strength	Between sensor outer cover and lead terminals: 500 VAC, 50/60 Hz min. for 1 min (leakage current: 1 mA max.)		
Weight	103 g		

Note: 1. Volumetric flow rate at 0°C, 101.3 kPa.

Note: 2. Dry gas. (must not contain large particles, e.g., dust, oil, or mist.)

Note: 3. Reference (typical)

Note: 4. With no condensation or icing.

Dimensions

CAD Data Please visit our CAD Data website, which is noted on the last page.

(Unit: mm)

MEMS Flow Sensors

CAD Data

D6F-10A5-000

D6F-20A5-000

D6F-50A5-000

Mounting Hole Dimensions

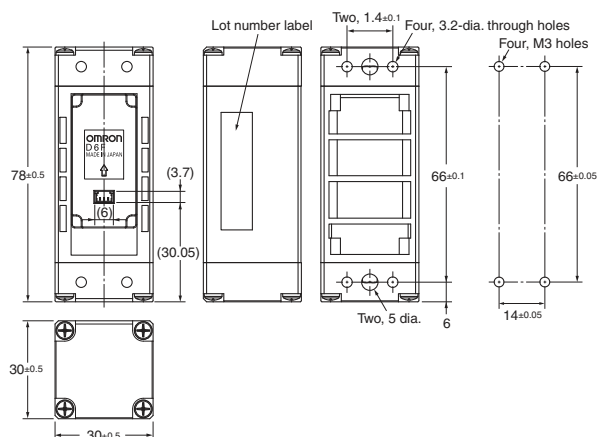

D6F-A6

MEMS Flow Sensor

High-Accuracy Sensing with a Compact Body for Flow Rates up to 50 L/min.

▶ Air ▶ Analog

- Accurately measures an air mass flow rate of 10 to 50 L/min.
- A compact size of 30 × 78 × 30 mm (H × W × D).

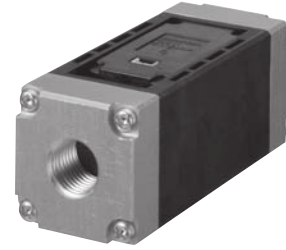

RoHS Compliant



Refer to the *Common Precautions for the D6F Series* on page 39.

Ordering Information

MEMS Flow Sensor

Flow Port Type	Applicable fluid	Flow rate range	Model
Rc 1/4 thread	Air	0 to 10 L/min	D6F-10A6-000
		0 to 20 L/min	D6F-20A6-000
		0 to 50 L/min	D6F-50A6-000
NPT 1/8 thread		0 to 10 L/min	D6F-10A61-000
		0 to 20 L/min	D6F-20A61-000
		0 to 50 L/min	D6F-50A61-000

Accessory (Sold separately)

Type	Model
Cable	D6F-CABLE1

Note: Refer to *Accessories for the D6F Series* on page 38.

Connections

D6F-10A6-000 **D6F-10A61-000**
D6F-20A6-000 **D6F-20A61-000**
D6F-50A6-000 **D6F-50A61-000**

Pin No. 1: Vcc
 2: Vout
 3: GND
 Connector 53398-03** (Made by Molex Japan)

Use the following connectors for connections to the D6F:
 Housing 51021-0300 (Made by Molex Japan)
 Terminals 50079 (Made by Molex Japan)
 Wires AWG28 to AWG26

1: Vcc 2: Vout 3: GND

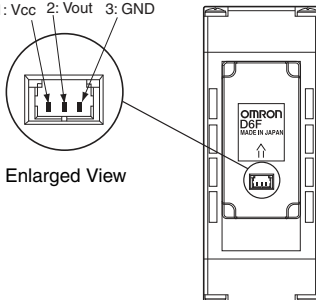

Output Voltage Characteristics

D6F-10A6-000
D6F-10A61-000

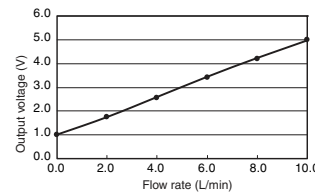

D6F-20A6-000
D6F-20A61-000

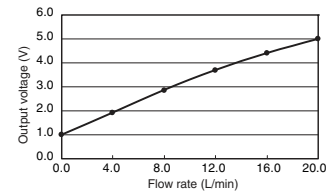

D6F-50A6-000
D6F-50A61-000

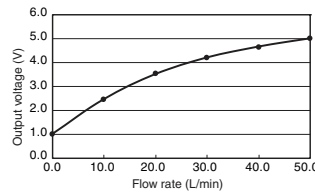

D6F-10A6-000/D6F-10A61-000

Flow rate L/min (normal)	0	2.0	4.0	6.0	8.0	10.0
Output voltage V	1.00	1.75	2.60	3.45	4.25	5.00
	±0.12	±0.12	±0.12	±0.12	±0.12	±0.12

D6F-20A6-000/D6F-20A61-000

Flow rate L/min (normal)	0	4	8	12	16	20
Output voltage V	1.00	1.93	2.87	3.70	4.41	5.00
	±0.12	±0.12	±0.12	±0.12	±0.12	±0.12

D6F-50A6-000/D6F-50A61-000

Flow rate L/min (normal)	0	10	20	30	40	50
Output voltage V	1.00	2.45	3.51	4.20	4.66	5.00
	±0.12	±0.12	±0.12	±0.12	±0.12	±0.12

Measurement conditions: Power supply voltage of 12±0.1 VDC, ambient temperature of 25±5°C, and ambient humidity of 35% to 75%.

Characteristics/Performance

Model	D6F-10A6-000	D6F-20A6-000	D6F-50A6-000	D6F-10A61-000	D6F-20A61-000	D6F-50A61-000
Flow Range (See note 1.)	0 to 10 L/min	0 to 20 L/min	0 to 50 L/min	0 to 10 L/min	0 to 20 L/min	0 to 50 L/min
Calibration Gas (See note 2.)	Air					
Flow Port Type	Rc 1/4 thread			NPT 1/8 thread		
Electrical Connection	Three-pin connector					
Power Supply	10.8 to 26.4 VDC					
Current Consumption	15 mA max. with no load, with a Vcc of 12 to 24 VDC, and at 25°C					
Output Voltage	1 to 5 VDC (non-linear output, load resistance of 10kΩ min.)					
Accuracy	±3% FS (25°C characteristic)					
Repeatability (See note 3.)	±0.3% FS					
Output Voltage (Max.)	5.7 VDC (Load resistance: 10 kΩ)					
Output Voltage (Min.)	0 VDC (Load resistance: 10 kΩ)					
Rated Power Supply Voltage	26.4 VDC					
Rated Output Voltage	6 VDC					
Case	PPS/aluminum alloy					
Degree of Protection	IEC IP40 (Excluding tubing sections.)					
Withstand Pressure	500 kPa					
Pressure Drop (See note 3.)	0.10 kPa	0.28 kPa	1.44 kPa	0.15 kPa	0.52 kPa	2.31 kPa
Operating Temperature (See note 4.)	-10 to 60°C					
Operating Humidity (See note 4.)	35% to 85%					
Storage Temperature (See note 4.)	-30 to 80°C					
Storage Humidity (See note 4.)	35% to 85%					
Temperature Characteristics	±3% FS for 25°C characteristic at an ambient temperature of -10 to 60°C					
Insulation Resistance	Between sensor outer cover and lead terminals: 20 MΩ min. (at 500 VDC)					
Dielectric Strength	Between sensor outer cover and lead terminals: 500 VAC, 50/60 Hz min. for 1 min (leakage current: 1 mA max.)					
Weight	103 g					

Note: 1. Volumetric flow rate at 0°C, 101.3 kPa.

Note: 2. Dry gas. (must not contain large particles, e.g., dust, oil, or mist.)

Note: 3. Reference (typical)

Note: 4. With no condensation or icing.

Dimensions

CAD Data Please visit our CAD Data website, which is noted on the last page.

(Unit: mm)

MEMS Flow Sensors

Mounting Hole Dimensions

CAD Data

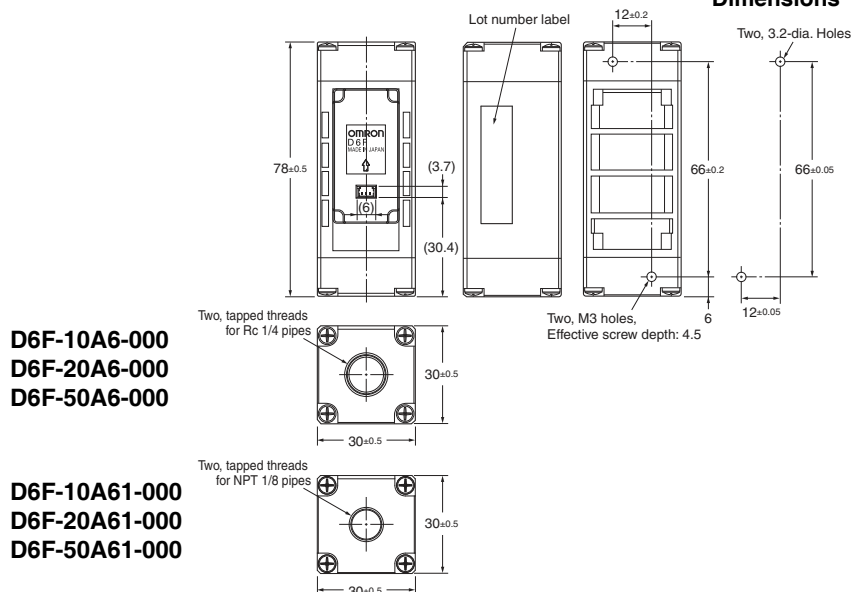

D6F-A7/-L7/-N7

MEMS Flow Sensor

Reduction of Piping Time by Quick Joint Connection

Air Gas Analog

- Low-flow rate of natural gas and LP gas can be measured.
- 10 L/min and 30 L/min of Air can be measured.
- Compact size of 30 × 84.6 × 30 mm (H × W × D).



RoHS Compliant



Refer to the *Common Precautions for the D6F Series* on page 39.

Ordering Information

MEMS Flow Sensor

Flow Port Type	Applicable fluid	Flow rate range	Model
Quick joint P10	Natural gas (13A)	0 to 5 L/min	D6F-05N7-000
	LP gas	0 to 2 L/min	D6F-02L7-000
	Air	0 to 10 L/min	D6F-10A7-000
		0 to 30 L/min	D6F-30A7-000

Accessories (Sold separately)

Type	Model
Cable	D6F-CABLE1
Quick fastener (for P10)	D6F-FASTENER-P10
Pipe fittings (for P10)	D6F-PLG1

Note: Refer to *Accessories for the D6F Series* on page 38.

Connections

D6F-05N7-000 D6F-02L7-000
D6F-10A7-000 D6F-30A7-000

Pin No. 1: Vcc
2: Vout
3: GND
Connector 53398-03** (Made by Molex Japan)

Use the following connectors for connections to the D6F:
Housing 51021-0300 (Made by Molex Japan)
Terminals 50079 (Made by Molex Japan)
Wires AWG28 to AWG26

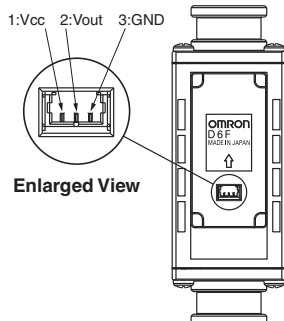

Output Voltage Characteristics

D6F-05N7-000

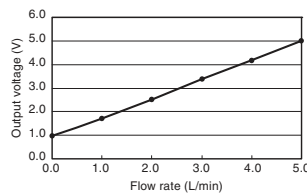

D6F-02L7-000

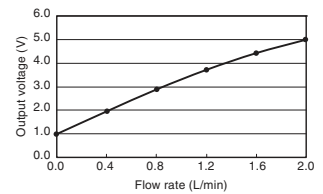

D6F-10A7-000

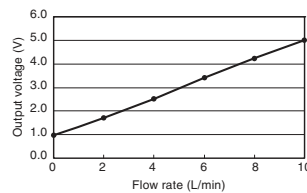

D6F-30A7-000

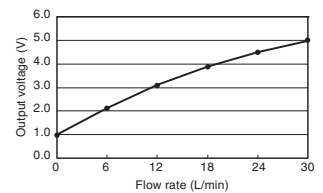

D6F-05N7-000

Flow rate L/min (normal)	0	1.0	2.0	3.0	4.0	5.0
Output voltage V	1.00	1.68	2.47	3.31	4.15	5.00
	±0.12	±0.12	±0.12	±0.12	±0.12	±0.12

D6F-02L7-000

Flow rate L/min (normal)	0	0.4	0.8	1.2	1.6	2.0
Output voltage V	1.00	1.96	2.89	3.72	4.43	5.00
	±0.12	±0.12	±0.12	±0.12	±0.12	±0.12

D6F-10A7-000

Flow rate L/min (normal)	0	2.0	4.0	6.0	8.0	10.0
Output voltage V	1.00	1.75	2.60	3.45	4.25	5.00
	±0.12	±0.12	±0.12	±0.12	±0.12	±0.12

D6F-30A7-000

Flow rate L/min (normal)	0	6	12	18	24	30
Output voltage V	1.00	2.11	3.12	3.91	4.53	5.00
	±0.12	±0.12	±0.12	±0.12	±0.12	±0.12

Measurement conditions: Power-supply voltage 12±0.1 VDC, ambient temperature 25±5°C and ambient humidity 35 to 75%RH.

Characteristics/Performance

Model	D6F-05N7-000	D6F-02L7-000	D6F-10A7-000	D6F-30A7-000
Flow Range (See note 1.)	0 to 5 L/min	0 to 2 L/min	0 to 10 L/min	0 to 30 L/min
Calibration Gas (See note 2.)	Natural gas (13A)	LP gas	Air	
Flow Port Type	Quick joint P10			
Electrical Connection	Three-pin connector			
Power Supply	10.8 to 26.4 VDC			
Current Consumption	15 mA max. with no load and Vcc of 12 to 24 VDC, GND = 0 VDC, 25°C			
Output Voltage	1 to 5 VDC (non-linear output, load resistance of 10 kΩ min.)			
Accuracy	±3%F.S. (25°C characteristic)			
Repeatability (See note 3.)	±0.3%F.S.			
Output Voltage (Max.)	5.7 VDC (Load resistance: 10 kΩ)			
Output Voltage (Min.)	0 VDC (Load resistance: 10 kΩ)			
Rated Power Supply Voltage	26.4 VDC			
Rated Output Voltage	6 VDC			
Case	PPS			
Degree of Protection	IEC IP40 (Excluding tubing sections.)			
Maximum Allowable Withstand Pressure	500 kPa			
Pressure Drop (See note 3.)	0.06 kPa	0.03 kPa	0.32 kPa	2.19 kPa
Operating Temperature (See note 4.)	-10 to +60°C			
Operating Humidity (See note 4.)	35 to 85%RH			
Storage Temperature (See note 4.)	-10 to +80°C		-30 to +80°C	
Storage Humidity (See note 4.)	35 to 85%RH			
Temperature Characteristics	±3%F.S. for 25°C characteristic at an ambient temperature of -10 to +60°C			
Insulation Resistance	Between sensor outer cover and lead terminals: 20 MΩ min. (at 500 VDC)			
Dielectric Strength	Between sensor outer cover and lead terminals: 500 VAC, 50/60 Hz min. for 1 min (leakage current: 1 mA max.)			
Weight	72 g			

Note: 1. Volumetric flow rate at 0°C, 101.3 kPa.

Note: 2. Dry gas (must not contain large particles, e.g., dust, oil, or mist.)

Note: 3. Reference (typical)

Note: 4. With no condensation or icing.

Dimensions

CAD Data Please visit our CAD Data website, which is noted on the last page.

(Unit: mm)

MEMS Flow Sensors

D6F-05N7-000

D6F-02L7-000

D6F-10A7-000

D6F-30A7-000

CAD Data

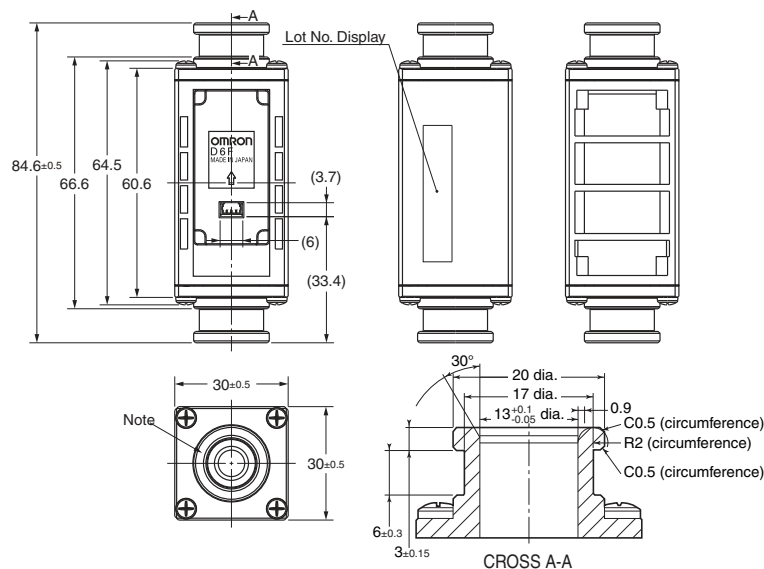

Recommended Quick joint male P10 type

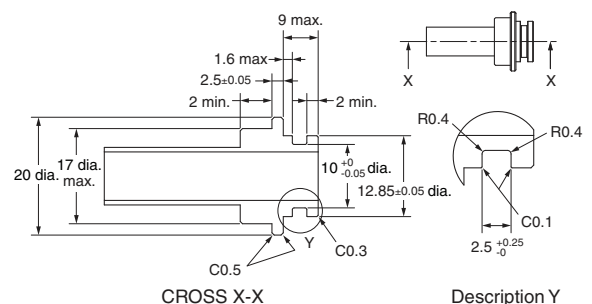

If using a Rc3/8 converter joint, the following is recommended.
 REGAL JOINT CO., LTD <http://www.rgl.co.jp/>
 Converter male joint (Rc3/8-Quick male joint): Adapter Rc3/8-QJM10
 O ring: O ring P10 fluororubber (material)

Note. The Port type of pipe fitting based on "Quick Joint P10 Type".

* P10 shows the name of an O-ring prescribed by JIS B 2401.

* The port of O-ring ditch is based on P10 of JIS B 2406.

* Please obtain a male joint separately.

D6F-A7D/-AB71D

MEMS Flow Sensor

Digital Compensation for High Accuracy

- Temperature compensation and linear compensation produce high accuracy ($\pm 3\%$ RD (25% to 100% FS)).
- Compact models for 10 to 70 L/min.
- Reduced piping work with quick-fastening feature.



RoHS Compliant



Refer to the *Common Precautions for the D6F Series* on page 39.

Ordering Information

MEMS Flow Sensor

Joint	Applicable fluid	Flow rate range	Model
Quick joint P10	Air	0 to 10 L/min	D6F-10A7D-000-0
		0 to 20 L/min	D6F-20A7D-000-0
		0 to 50 L/min	D6F-50A7D-000-0
Quick joint P14		0 to 70 L/min	D6F-70AB71D-000-0

Accessories (Sold separately)

Type	Model
Cable	D6F-CABLE3
Quick fastener (for P10)	D6F-FASTENER-P10
Pipe fittings (for P10)	D6F-PLG1

Note: Refer to *Accessories for the D6F Series* on page 38.

Connections

D6F-10A7D-000-0

D6F-20A7D-000-0

D6F-50A7D-000-0

D6F-70AB71D-000-0

Pin No. 1: Vcc
2: SDA
3: SCL
4: GND

Connector BM04B-GHS (made by J.S.T. Mfg. Co.)

Use the following connectors for connections to the D6F:

Housing GHR-04V-S (made by J.S.T. Mfg. Co.)

Terminals SSSL-002T-P0.2 (made by J.S.T. Mfg. Co.)

Wires AWG26 to AWG30

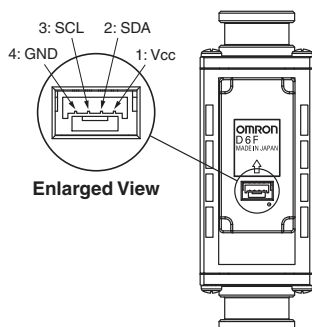

Output Characteristics

D6F-10A7D-000-0

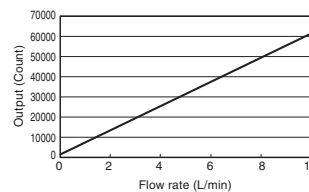

D6F-20A7D-000-0

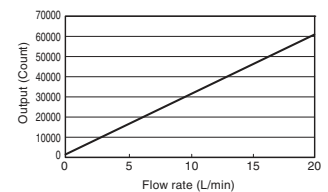

D6F-50A7D-000-0

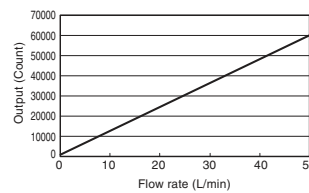

D6F-70AB71D-000-0

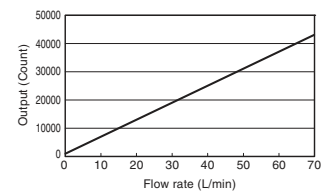

D6F-10A7D-000-0

Flow rate L/min (normal)	0	2	4	6	8	10
Output (HEX)	1024 (0400)	13024 (32E0)	25024 (61C0)	37024 (90A0)	49024 (BF80)	61024 (EE60)

Measurement conditions: Power-supply voltage 3.3 ± 0.1 VDC, ambient temperature $25 \pm 5^\circ\text{C}$ and ambient humidity 35 to 75%RH.

Flow rate = (Output value - 1,024)/60,000 x 10

D6F-20A7D-000-0

Flow rate L/min (normal)	0	4	8	12	16	20
Output (HEX)	1024 (0400)	13024 (32E0)	25024 (61C0)	37024 (90A0)	49024 (BF80)	61024 (EE60)

Measurement conditions: Power-supply voltage 3.3 ± 0.1 VDC, ambient temperature $25 \pm 5^\circ\text{C}$ and ambient humidity 35 to 75%RH.

Flow rate = (Output value - 1,024)/60,000 x 20

D6F-50A7D-000-0

Flow rate L/min (normal)	0	10	20	30	40	50
Output (HEX)	1024 (0400)	13024 (32E0)	25024 (61C0)	37024 (90A0)	49024 (BF80)	61024 (EE60)

Measurement conditions: Power-supply voltage 3.3 ± 0.1 VDC, ambient temperature $25 \pm 5^\circ\text{C}$ and ambient humidity 35 to 75%RH.

Flow rate = (Output value - 1,024)/60,000 x 50

D6F-70AB71D-000-0

Flow rate L/min (normal)	0	20	40	60	70
Output (HEX)	1024 (0400)	13024 (32E0)	25024 (61C0)	37024 (90A0)	43024 (A810)

Measurement conditions: Power-supply voltage 3.3 ± 0.1 VDC, ambient temperature $25 \pm 5^\circ\text{C}$ and ambient humidity 35 to 75%RH.

Flow rate = (Output value - 1,024)/60,000 x 100

Characteristics/Performance

Model	D6F-10A7D-000-0	D6F-20A7D-000-0	D6F-50A7D-000-0	D6F-70AB71D-000-0
Flow Range (See note 1.)	0 to 10L/min	0 to 20 L/min	0 to 50 L/min	0 to 70 L/min
Calibration Gas (See note 2.)	Air			
Flow Port Type	Quick joint P10			Quick joint P14
Electrical Connection	Four-pin connector			
Power Supply	3.0 to 3.6 VDC			
Current Consumption	10 mA max. with no load, Vcc = 3.3 VDC, GND = 0 VDC, 25°C			
Resolution	15 bit			
Accuracy (See note 3.)	±5%RD (10%F.S. ≤ Flow rate < 25%F.S.) ±3%RD (25%F.S. ≤ Flow rate ≤ 100%F.S.)			±5%RD (10L/min ≤ Flow rate < 20L/min) ±3%RD (20L/min ≤ Flow rate ≤ 70L/min)
Response time	90 ms max.			
Repeatability (See note 4.)	0.3 %RD	0.3%RD	0.5%RD	1.3%RD
Interface (See note 5.)	I2C			
Case	PPS			
Degree of Protection	IEC IP40 (Excluding tubing sections.)			
Maximum Allowable Withstand Pressure	100 kPa			
Pressure Drop (See note 4.)	0.034 kPa	0.083 kPa	0.28 kPa	0.57 kPa
Operating Temperature (See note 6.)	-10 to +60°C			
Operating Humidity (See note 6.)	35 to 85%RH			
Storage Temperature (See note 6.)	-30 to +80°C			
Storage Humidity (See note 6.)	35 to 85%RH			
Insulation Resistance	Between sensor outer cover and lead terminals: 20 MΩ min. (at 500 VDC)			
Dielectric Strength	Between sensor outer cover and lead terminals: 500 VAC, 50/60 Hz min. for 1 min (leakage current: 1 mA max.)			
Weight	57.3 g			64.4 g

Note: 1. Volumetric flow rate at 0°C, 101.3 kPa.

Note: 2. Dry gas (must not contain large particles, e.g., dust, oil, or mist.)

Note: 3. -10 ≤ Operating Temperature ≤ 60°C

Note: 4. Reference (typical)

Note: 5. Refer to the *MEMS Flow Sensor D6F-A7D/-AB71D User's Manual* for details.

Note: 6. With no condensation or icing.

Note: 7. The following custom options are available.

Ask your OMRON representative for details.

- Temperature measurement
- Address settings (up to four addresses)
- Fault detection
- Threshold setting

Communication

Serial Interface	I2C
Master/Slave	Slave / Address: HEX : 0x6C BIN : 110_1100 (7bit)
Speed mode	Fast Mode 400kHz
Signal	
SCL	Serial Clock
SDA	Data Signal

● Evaluation Board (Sold separately)

The D6F-A7D/-AB71D MEMS flow sensor can be connected to the OMRON sensor evaluation board.

The following three platforms are supported, and evaluation can easily be performed by connecting the flow sensor, evaluation board, and harness to the platform.

Platform	Evaluation board	Connection harness (between the evaluation board and sensor)	MEMS flow sensor	Sample code
For connecting to Raspberry Pi (See note 1.)	2JCIE-EV01-RP1	2JCIE-HARNESS-03	D6F-10A7D-000-0 D6F-20A7D-000-0 D6F-50A7D-000-0 D6F-70AB71D-000-0	https://github.com/omron-devhub/d6f-2jcieev01-raspberrypi
For connecting to Arduino (See note 2.)	2JCIE-EV01-AR1			https://github.com/omron-devhub/d6f-2jcieev01-arduino
For connecting to ESP32 Feather (See note 3.)	2JCIE-EV01-FT1			https://github.com/omron-devhub/d6f-2jcieev01-arduino

For more information about the evaluation board, please visit the following URL.

(<https://components.omron.com/sensor/evaluation-board/2jcie>)

Note: 1. Raspberry Pi is a registered trademark of the Raspberry Pi Foundation.

Note: 2. Arduino is a registered trademark of Arduino LLC and Arduino SRL.

Note: 3. Feather is a registered trademark of Adafruit Industries LLC.

Dimensions

CAD Data Please visit our CAD Data website, which is noted on the last page.

(Unit: mm)

MEMS Flow Sensors

D6F-10A7D-000-0
D6F-20A7D-000-0
D6F-50A7D-000-0

CAD Data

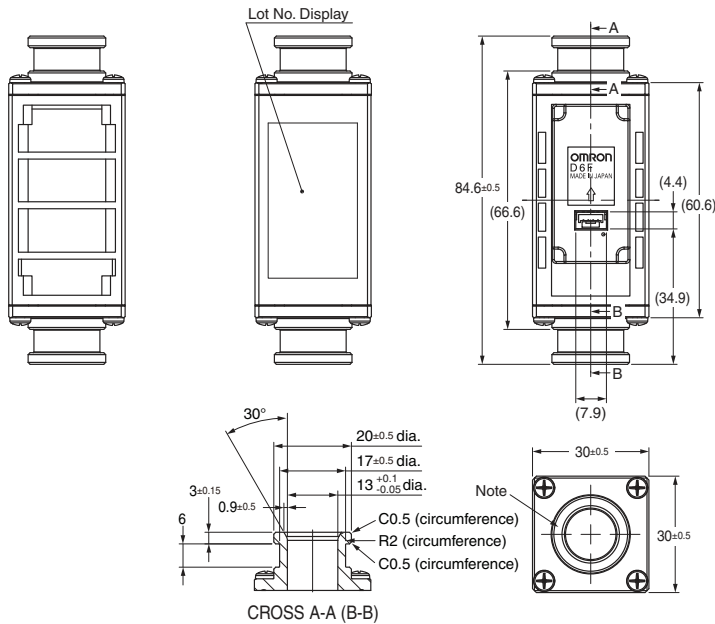

Recommended Quick joint male P10 type

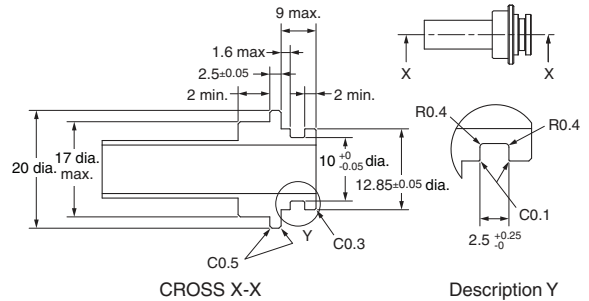

If using a Rc3/8 converter joint, the following is recommended.
REGAL JOINT CO., LTD <http://www.rgl.co.jp/>
Converter male joint (Rc3/8-Quick male joint): Adapter Rc3/8-QJM10
O ring: O ring P10 fluororubber (material)

- Note 1. Note . The Port type of pipe fitting based on "Quick Joint P10 Type".
* P10 shows the name of an O-ring prescribed by JIS B 2401.
* The port of O-ring ditch is based on P10 of JIS B 2406.
* Please obtain a male joint separately.
- Note 2. Use the following connectors to connect to the Sensor.
Connector :GHR-04V-S (JST)
Terminals :SSHL-002T-P0.2 (JST)
Wires :AWG26 to AWG30
Circuit numbers :1.Vcc, 2.SDA, 3.SCL, 4.GND

D6F-70AB71D-000-0

CAD Data

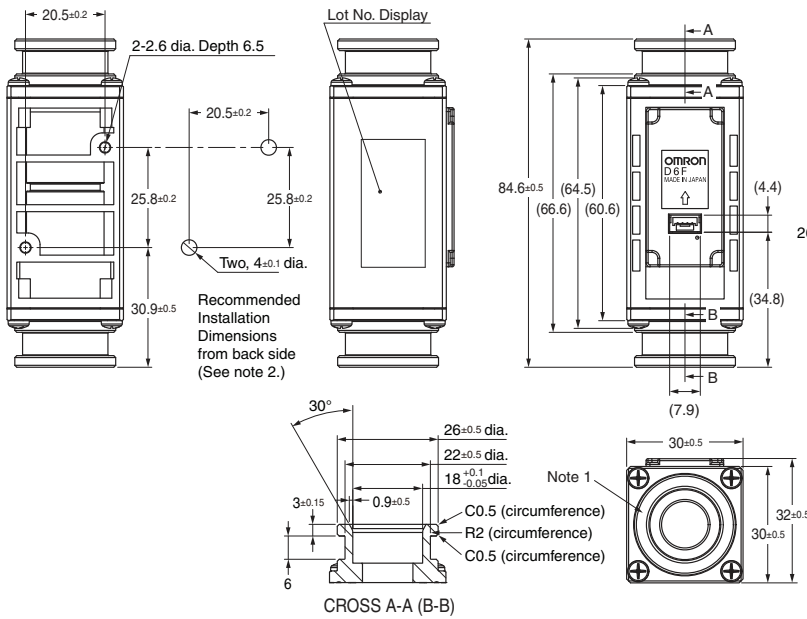

Recommended Quick joint male P14 type

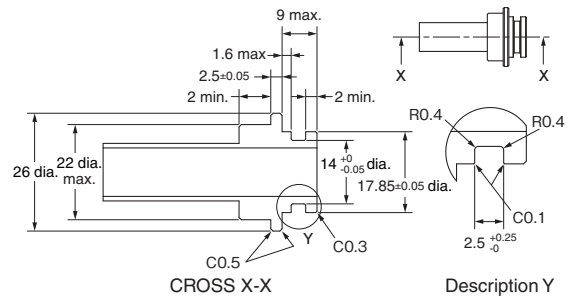

If using a Rc3/8 converter joint, the following is recommended.
REGAL JOINT CO., LTD <http://www.rgl.co.jp/>
Converter male joint (Rc3/8-Quick male joint): Adapter Rc3/8-QJM14
O ring: O ring P14 fluororubber (material)

- Note 1. The Port type of pipe fitting based on "Quick Joint P14 Type".
* P14 shows the name of an O-ring prescribed by JIS B 2401.
* The port of O-ring ditch is based on P14 of JIS B 2406.
* Please obtain a male joint separately.
- Note 2. To mount the Sensor with 2.6-dia. holes, use P-type self-tapping screws with a nominal diameter of 3 mm and tighten them to a torque of 1.2 N·m max. The screw threads must engage for 5.5 mm min.
- Note 3. Use the following connectors to connect to the Sensor.
Connector :GHR-04V-S (JST)
Terminals :SSHL-002T-P0.2 (JST)
Wires :AWG26 to AWG30
Circuit numbers :1.Vcc, 2.SDA, 3.SCL, 4.GND

D6F-AB71

MEMS Flow Sensor

Reduction of Piping Time by Quick Joint Connection

Air Analog

- Reduce the influence of pulsation flow by bypass flow path
- Compact size of 30 × 84.6 × 32 mm (H × W × D).

RoHS Compliant



Refer to the *Common Precautions for the D6F Series* on page 39.



Ordering Information

MEMS Flow Sensor

Flow Port Type	Applicable fluid	Flow rate range	Model
Quick joint P14	Air	0 to 30 L/min	D6F-30AB71-000
		0 to 70 L/min	D6F-70AB71-000

Accessory (Sold separately)

Type	Model
Cable	D6F-CABLE1

Note: Refer to *Accessories for the D6F Series* on page 38.

Connections

D6F-30AB71-000

D6F-70AB71-000

Pin No. 1: Vcc
2: Vout
3: GND

Connector 53398-03** (Made by Molex Japan)

Use the following connectors for connections to the D6F:

Housing 51021-0300 (Made by Molex Japan)
Terminals 50079 (Made by Molex Japan)
Wires AWG28 to AWG26

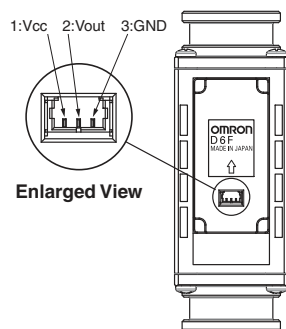

Output Voltage Characteristics

D6F-30AB71-000

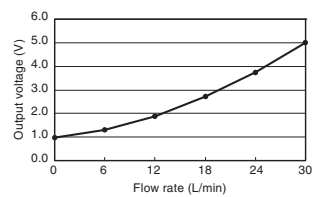

D6F-70AB71-000

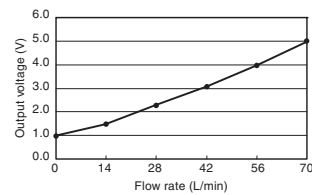

D6F-30AB71-000

Flow rate L/min (normal)	0	6	12	18	24	30
Output voltage V	1.00 ±0.12	1.25 ±0.12	1.91 ±0.12	2.75 ±0.12	3.78 ±0.12	5.00 ±0.12

D6F-70AB71-000

Flow rate L/min (normal)	0	14	28	42	56	70
Output voltage V	1.00 ±0.12	1.43 ±0.12	2.25 ±0.12	3.14 ±0.12	4.06 ±0.12	5.00 ±0.12

Measurement conditions: Power-supply voltage 12±0.1 VDC, ambient temperature 25±5°C and ambient humidity 35 to 75%RH.

Characteristics/Performance

Model	D6F-30AB71-000	D6F-70AB71-000
Flow Range (See note 1.)	0 to 30 L/min	0 to 70 L/min
Calibration Gas (See note 2.)	Air	
Flow Port Type	Quick joint P14	
Electrical Connection	Three-pin connector	
Power Supply	10.8 to 26.4 VDC	
Current Consumption	15 mA max. with no load and Vcc of 12 to 24 VDC, GND = 0 VDC, 25°C	
Output Voltage	1 to 5 VDC (non-linear output, load resistance of 10 kΩ min.)	
Accuracy	±3%F.S. (25°C characteristic)	
Repeatability (See note 3.)	±0.3%F.S.	
Output Voltage (Max.)	5.7 VDC (Load resistance: 10 kΩ)	
Output Voltage (Min.)	0 VDC (Load resistance: 10 kΩ)	
Rated Power Supply Voltage	26.4 VDC	
Rated Output Voltage	6 VDC	
Case	PPS	
Degree of Protection	IEC IP40 (Excluding tubing sections.)	
Withstand Pressure	100 kPa	
Pressure Drop (See note 3.)	0.88 kPa	3.49 kPa
Operating Temperature (See note 4.)	-10 to +60°C	
Operating Humidity (See note 4.)	35 to 85%RH	
Storage Temperature (See note 4.)	-30 to +80°C	
Storage Humidity (See note 4.)	35 to 85%RH	
Temperature Characteristics	±3%F.S. for 25°C characteristic at an ambient temperature of -10 to +60°C	
Insulation Resistance	Between sensor outer cover and lead terminals: 20 MΩ min. (at 500 VDC)	
Dielectric Strength	Between sensor outer cover and lead terminals: 500 VAC, 50/60 Hz min. for 1 min (leakage current: 1 mA max.)	
Weight	75 g	

Note 1. Volumetric flow rate at 0°C, 101.3 kPa.

Note 2. Dry gas (must not contain large particles, e.g., dust, oil, or mist.)

Note 3. Reference (typical)

Note 4. With no condensation or icing.

Dimensions

CAD Data Please visit our CAD Data website, which is noted on the last page.

(Unit: mm)

MEMS Flow Sensors

D6F-30AB71-000

D6F-70AB71-000

CAD Data

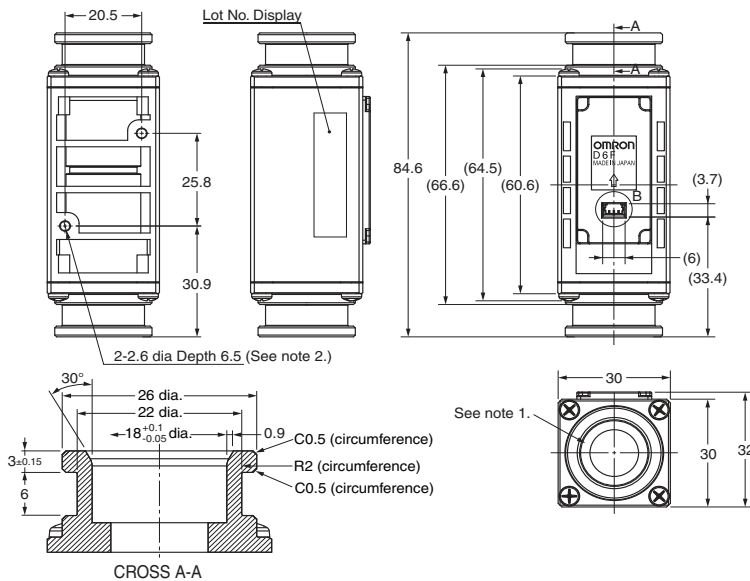

Recommended Quick joint male P14 type

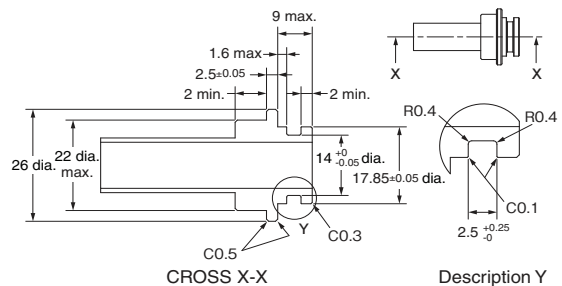

CROSS X-X

Description Y

If using a Rc3/8 converter joint, the following is recommended.
 REGAL JOINT CO., LTD <http://www.rgl.co.jp/>
 Converter male joint (Rc3/8-Quick male joint): Adapter Rc3/8-QJM14
 O ring: O ring P14 fluororubber (material)

- Note 1. The flow path inlet and outlet ports conform to P14-type female quick-connect joints.
 (The tube inlet and outlet ports have the same shape.)
 * P14 is the number of an O-ring specified in JIS B 2401.
 * The O-ring groove in the male joint must conform to P14 in JIS B 2406.
 * Please obtain a male joint separately.
- Note 2. To mount the Sensor with 2.6-dia. holes, use P-type self-tapping screws with a nominal diameter of 3 mm and tighten them to a torque of 1.2 N·m max. The screw threads must engage for 5.5 mm min.
- Note 3. Use the following connectors to connect to the Sensor.
 Connector : GHR-04V-S (JST)
 Terminals : SSLH-002T-P0.2 (JST)
 Wires : AWG26 to AWG30
 Circuit numbers : 1. Vcc, 2. SDA, 3. SCL, and 4. GND.

D6F-P

MEMS Flow Sensor

Air Analog

A Compact, High-Accuracy Flow Sensor with Superior Resistance to Environments.

- Anti-dust performance is improved using the Cyclon method.
- A full lineup of models with different connector types: bamboo joints, lead terminals for direct mounting on-board, and manifolds.
- High accuracy of $\pm 5\%$ FS.

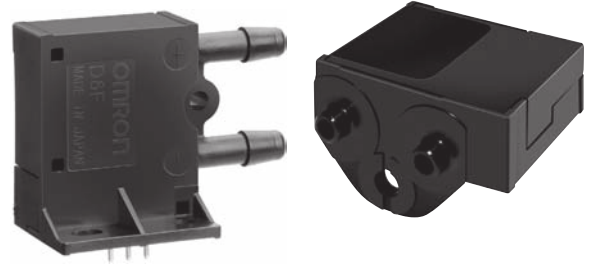

RoHS Compliant



Refer to the *Common Precautions for the D6F Series* on page 39.

Ordering Information

MEMS Flow Sensor

Flow Port Type	Connection	Applicable fluid	Flow Rate Change	Model
Bamboo joint	Lead terminals	Air	0 to 0.1 L/min	D6F-P0001A1
			0 to 1 L/min	D6F-P0010A1
Manifold	Connector		0 to 1 L/min	D6F-P0010A2
				D6F-P0010AM2

Accessory (Sold separately)

Type	Model
Cable	D6F-CABLE2
	D6F-CABLE2-L

Note: Refer to *Accessories for the D6F Series* on page 38.

Output Voltage Characteristics

D6F-P0001A1

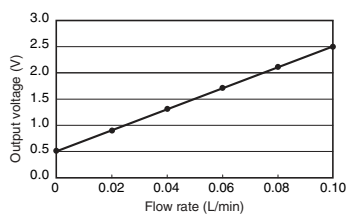

Flow rate L/min (normal)	0	0.02	0.04	0.06	0.08	0.10
Output voltage V	0.50	0.90	1.30	1.70	2.10	2.50
	± 0.10	± 0.10	± 0.10	± 0.10	± 0.10	± 0.10

Measurement conditions: Power supply voltage of 5.0 ± 0.1 VDC, ambient temperature of $25 \pm 5^\circ\text{C}$, and ambient humidity of 35% to 75%.

D6F-P0010A1/-P0010A2/-P0010AM2

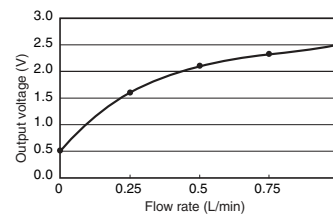

Flow rate L/min (normal)	0	0.25	0.50	0.75	1.00
Output voltage V	0.50	1.60	2.10	2.31	2.50
	± 0.10	± 0.10	± 0.10	± 0.10	± 0.10

Measurement conditions: Power supply voltage of 5.0 ± 0.1 VDC, ambient temperature of $25 \pm 5^\circ\text{C}$, and ambient humidity of 35% to 75%.

Characteristics/Performance

Model	D6F-P0001A1	D6F-P0010A1	D6F-P0010A2	D6F-P0010AM2
Flow Range (See note 1.)	0 to 0.1 L/min	0 to 1 L/min		
Calibration Gas (See note 2.)	Air			
Flow Port Type	Bamboo joint Maximum outside diameter: 4.9 mm, minimum outside diameter: 4.0 mm			Manifold
Electrical Connection	Lead terminals		Three-pin connector	
Power Supply	4.75 to 5.25 VDC			
Current Consumption	15 mA max. with no load and a Vcc of 5.0 V			
Output Voltage	0.5 to 2.5 VDC (Load resistance: 10 kΩ)			
Accuracy	±5% FS (25°C characteristic)			
Repeatability (See note 3.)	±1.0% FS	±0.4% FS		
Output Voltage (Max.)	3.1 VDC (Load resistance: 10 kΩ)			
Output Voltage (Min.)	0 VDC (Load resistance: 10 kΩ)			
Rated Power Supply Voltage	10 VDC			
Rated Output Voltage	4 VDC			
Case	PBT			
Degree of Protection	IEC IP40 (Excluding tubing sections.)			
Withstand Pressure (See note 3.)	50 kPa			
Pressure Drop (See note 3.)	0.005 kPa	0.19 kPa	0.67 kPa	
Operating Temperature (See note 4.)	-10 to +60°C			
Operating Humidity (See note 4.)	35% to 85%			
Storage Temperature (See note 4.)	-40 to +80°C			
Storage Humidity (See note 4.)	35% to 85%			
Temperature Characteristics	±5% FS for 25°C characteristic at an ambient temperature of -10 to +60°C			
Insulation Resistance	Between sensor outer cover and lead terminals: 20 MΩ min. (at 500 VDC)			
Dielectric Strength	Between sensor outer cover and lead terminals: 500 VAC, 50/60 Hz min. for 1 min (leakage current: 1 mA max.)			
Weight	8.5 g			8.0 g

Note: 1. Volumetric flow rate at 0°C, 101.3 kPa.

Note: 2. Dry gas. (must not contain large particles, e.g., dust, oil, or mist.)

Note: 3. Reference (typical)

Note: 4. With no condensation or icing.

Tubing

You can measure large flows by mounting the Sensor on a bypass.

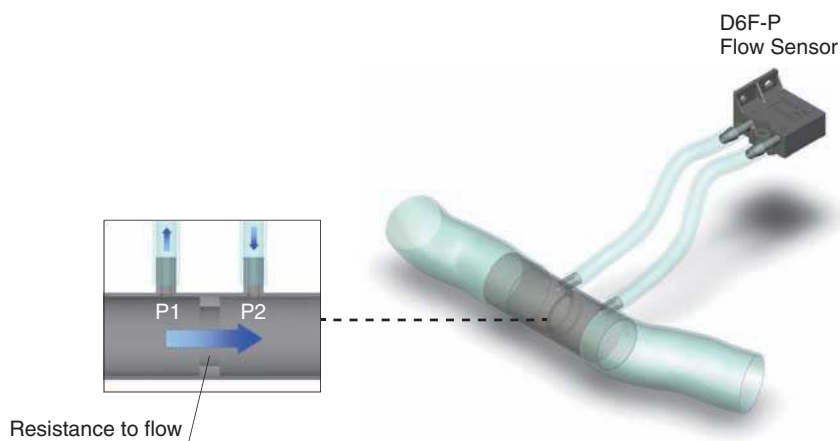

Mounting Direction Bamboo joint Sensor

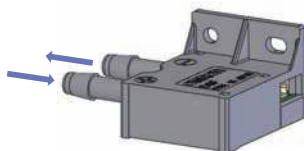

Manifold-type Sensor

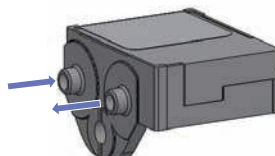

D6F-PH

MEMS Differential Pressure Sensor

A Compact, High-Accuracy Differential Pressure Sensor with Superior Resistance to Environments.

 Air  Digital



- High accuracy of $\pm 3\%$ RD
- Linearized and temperature compensated
- Digital output (I2C communication)
- High flow impedance to reduce the influence of bypass configuration

RoHS Compliant



Refer to the *Common Precautions for the D6F Series* on page 39.

Ordering Information

Applicable fluid (See note 1.)	Differential pressure range (See note 3.)	Flow Port Type	Connection	Model
Air (See note 2.)	0 to 250 Pa	Bamboo joint	Lead terminals	D6F-PH0025AD1
			Connector	D6F-PH0025AD2
		Manifold	Connector	D6F-PH0025AMD2
	± 50 Pa	Bamboo joint	Lead terminals	D6F-PH0505AD3
			Connector	D6F-PH0505AD4
		Manifold	Connector	D6F-PH0505AMD4
	± 500 Pa	Bamboo joint	Lead terminals	D6F-PH5050AD3
			Connector	D6F-PH5050AD4
		Manifold	Connector	D6F-PH5050AMD4

Note. Models with different slave addresses are also available. Consult your OMRON representative for details.

Note: 1. The Sensor be calibrated for different gas types. Consult your Omron representative.

Note: 2. Dry gas must not contain large particles, e.g., dust, oil, or mist.

Note: 3. At standard atmospheric pressure (1013.25 hPa)

● Accessory (Sold separately)

Type	Model
Cable	D6F-CABLE3

Note. This cable is for connection with the D6F-PH0025AD2, D6F-PH0025AMD2, D6F-PH0505AD4, D6F-PH0505AMD4, D6F-PH5050AD4, and D6F-PH5050AMD4 connector-type models. One side is a connector and the other side is a lead wire.

Note. Refer to *Accessories for the D6F Series* on page 38.

● Evaluation Board (Sold separately)

The D6F-PH MEMS differential pressure sensor can be connected to the OMRON sensor evaluation board.

The following three platforms are supported, and evaluation can easily be performed by connecting the differential pressure sensor, evaluation board, and harness to the platform.

Platform	Evaluation board	Sample code	Connection harness (between the evaluation board and D6F-PH)	Compatible differential pressure sensor D6F-PH
For connecting to Raspberry Pi (See note 1.)	2JCIE-EV01-RP1	https://github.com/omron-devhub/d6f-2jcieev01-raspberrypi	2JCIE-HARNESS-02 (See note 4.)	D6F-PH0025AD1 D6F-PH0505AD3 D6F-PH5050AD3
For connecting to Arduino (See note 2.)	2JCIE-EV01-AR1	https://github.com/omron-devhub/d6f-2jcieev01-arduino	2JCIE-HARNESS-03 (See note 5.)	D6F-PH0025AD2 D6F-PH0505AD4 D6F-PH5050AD4 D6F-PH0025AMD2 D6F-PH0505AMD4 D6F-PH5050AMD4
For connecting to ESP32 Feather (See note 3.)	2JCIE-EV01-FT1	https://github.com/omron-devhub/d6f-2jcieev01-arduino		

For more information about the evaluation board, please visit the following URL.

(<https://components.omron.com/sensor/evaluation-board/2jcie>)

For information on how to use the sample code, please refer to the D6F-PH User's Manual.

Note: 1. Raspberry Pi is a registered trademark of the Raspberry Pi Foundation.

Note: 2. Arduino is a registered trademark of Arduino LLC and Arduino SRL.

Note: 3. Feather is a registered trademark of Adafruit Industries LLC.

Note: 4. The 2JCIE-HARNESS-02 is a connector on one side and a lead wire on the other. The lead wire must be connected to the D6F-PH for use.

Note: 5. The 2JCIE-HARNESS-03 has connectors on both sides. Both the D6F-PH and the evaluation board can be easily connected using these connectors.

Output Characteristics

D6F-PH0025AD1
D6F-PH0025AD2
D6F-PH0025AMD2

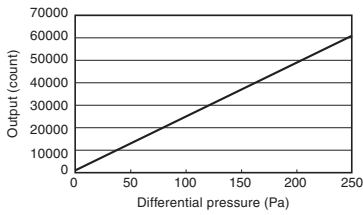

Differential pressure (Pa)	0	50	100	150	200	250
Output (HEX)	1024 (0400)	13024 (32E0)	25024 (61C0)	37024 (90A0)	49024 (BF80)	61024 (EE60)

Measurement conditions: Power supply voltage of 3.3 ± 0.1 VDC, ambient temperature of $25 \pm 5^\circ\text{C}$, and ambient humidity of 35% to 75%.

Differential pressure conversion formula: $Dp = (Op - 1024) / 60000 \times 250$
 Dp = Differential pressure, Op = Output

D6F-PH5050AD3
D6F-PH5050AD4
D6F-PH5050AMD4

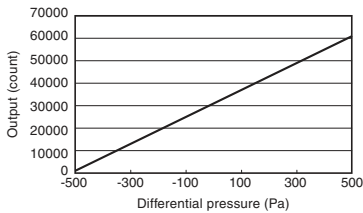

Differential pressure (Pa)	-500	-300	-100	0	100	300	500
Output (HEX)	1024 (0400)	13024 (32E0)	25024 (61C0)	31024 (7930)	37024 (90A0)	49024 (BF80)	61024 (EE60)

Measurement conditions: Power supply voltage of 3.3 ± 0.1 VDC, ambient temperature of $25 \pm 5^\circ\text{C}$, and ambient humidity of 35% to 75%.

Differential pressure conversion formula: $Dp = (Op - 1024) / 60000 \times 1000 - 500$
 Dp = Differential pressure, Op = Output

D6F-PH0505AD3
D6F-PH0505AD4
D6F-PH0505AMD4

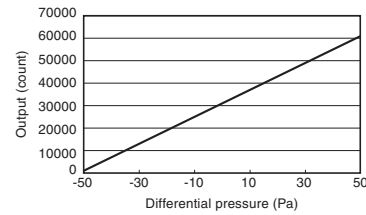

Differential pressure (Pa)	-50	-30	-10	0	10	30	50
Output (HEX)	1024 (0400)	13024 (32E0)	25024 (61C0)	31024 (7930)	37024 (90A0)	49024 (BF80)	61024 (EE60)

Measurement conditions: Power supply voltage of 3.3 ± 0.1 VDC, ambient temperature of $25 \pm 5^\circ\text{C}$, and ambient humidity of 35% to 75%.

Differential pressure conversion formula: $Dp = (Op - 1024) / 60000 \times 100 - 50$
 Dp = Differential pressure, Op = Output

Note. Change of gas density affects the sensor output.
 Change of atmospheric pressure is compensated by the following formula.
 $Dpeff = Dp \times (Pstd / Pamb)$
 Dpeff: Effective differential pressure
 Dp: Differential pressure of the sensor output
 Pstd: Standard atmospheric pressure (1013.25 hPa)
 Pamb: Actual ambient atmospheric pressure (hPa)

Characteristics/Performance

Model	D6F-PH0025AD1	D6F-PH0025AD2	D6F-PH0025AMD2	D6F-PH0505AD3	D6F-PH0505AD4	D6F-PH0505AMD4	D6F-PH5050AD3	D6F-PH5050AD4	D6F-PH5050AMD4
Differential pressure range (See note 1)	0 to 250 Pa			±50 Pa			±500 Pa		
Calibration Gas (See note 2.)	Air								
Port Type	Bamboo joint Maximum outside diameter: 4.9 mm, minimum outside diameter: 4.0 mm		Manifold	Bamboo joint Maximum outside diameter: 4.9 mm, minimum outside diameter: 4.0 mm		Manifold	Bamboo joint Maximum outside diameter: 4.9 mm, minimum outside diameter: 4.0 mm		Manifold
Electrical Connection	Lead terminals	Four-pin connector	Four-pin connector	Lead terminals	Four-pin connector	Four-pin connector	Lead terminals	Four-pin connector	Four-pin connector
Power Supply	2.3 to 3.6 VDC								
Current Consumption	6 mA max. with no load and Vcc of 3.3 VDC, GND = 0 VDC, 25°C								
Resolution	12 bit								
Zero point tolerance (See note 3.)	±0.2 Pa								
Span tolerance (See note 3.)	±3% RD								
Span shift due to temperature variation	< 0.5% RD per 10°C								
Response time	33 ms typical at 12 bit resolution (50 ms max.) The processing time is 6 ms typical at 12 bit resolution.								
Gas flow through sensor (See note 5.)	63 mL/min			23 mL/min			100 mL/min		
Interface	I2C								
Case material	PPS								
Degree of Protection	IEC IP40 (Excluding tubing sections.)								
Withstand Pressure	10 kPa								
Operating temperature (See note 4.)	-20 to +80°C								
Operating humidity (See note 4.)	35 to 85 %RH								
Storage temperature (See note 4.)	-40 to +80°C								
Storage humidity (See note 4.)	35 to 85 %RH								
Insulation Resistance	Between sensor outer cover and lead terminals: 20 MΩ min. (at 500 VDC)								
Dielectric Strength	Between sensor outer cover and lead terminals: 500 VAC, 50/60 Hz min. for 1 min (leakage current: 1 mA max.)								
Weight	5.0 g	5.0 g	5.4 g	5.0 g	5.0 g	5.4 g	5.0 g	5.0 g	5.4 g

Note: 1. At standard atmospheric pressure (1013.25 hPa)

Note: 2. Dry gas must not contain large particles, e.g., dust, oil, or mist.

Note: 3. The zero point tolerance and span tolerance are independent uncertainties and add according to the principles of error propagation.

Note: 4. With no condensation or icing.

Note: 5. Type D6F-PH is based on thermal flow principle. Air flow is needed to measure the differential pressure.

Typical characteristic of air flow by differential pressure is below.

Relation between pressure and flow rate

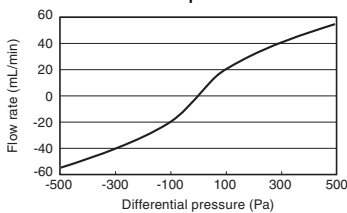

Tubing (Example for Bamboo Joint)

You can use the bypass method to connect and measure the differential pressure.

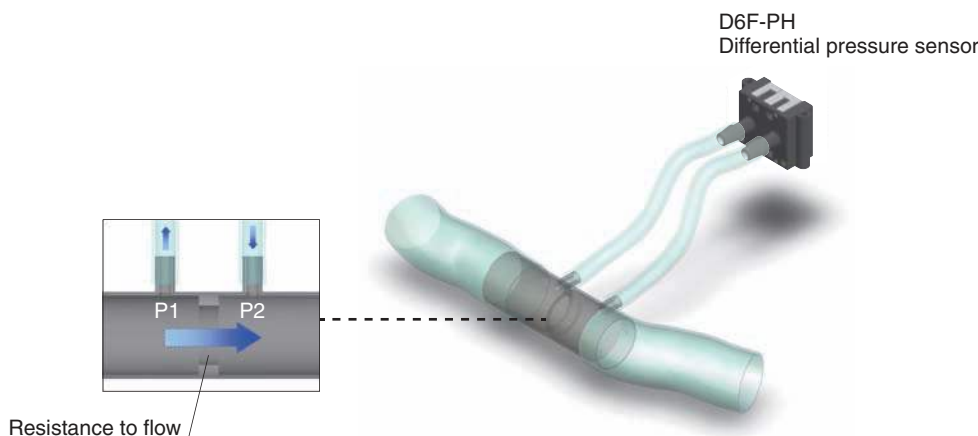

Connections/Dimensions

CAD Data Please visit our CAD Data website, which is noted on the last page.

(Unit: mm)

● Lead Terminals

D6F-PH0025AD1
D6F-PH0505AD3
D6F-PH5050AD3

CAD Data

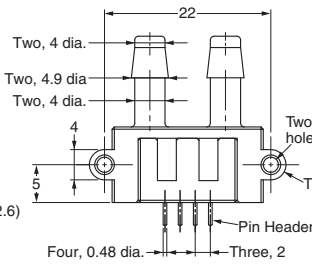
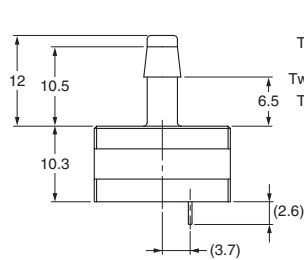
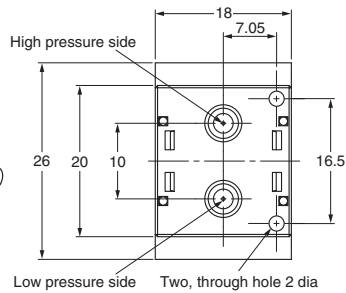
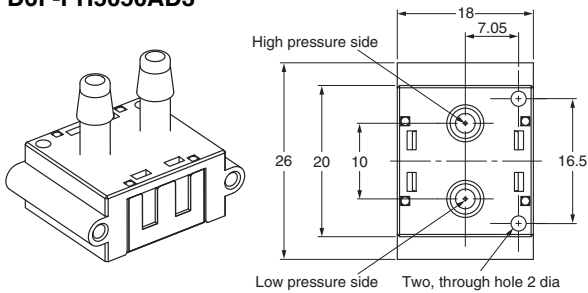

Recommendation size for pin header installation (tolerances: ± 0.1)

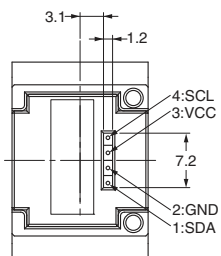
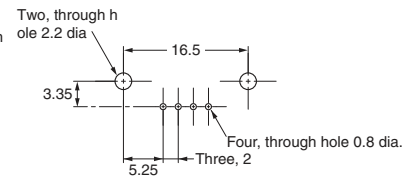

Tubes

Install tubes made of materials such as rubber, urethane or nylon so that they will not come out. For urethane tubes, tubes with an outer diameter of 6 mm and an inner diameter of 4 mm are recommended.

Soldering Conditions

Use a soldering iron for 5 s at 350°C with a pressure of 100 gf max.

D6F-PH

MEMS Differential Pressure Sensor

● Connectors

D6F-PH0025AD2
D6F-PH0505AD4
D6F-PH5050AD4

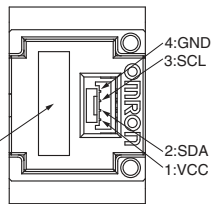
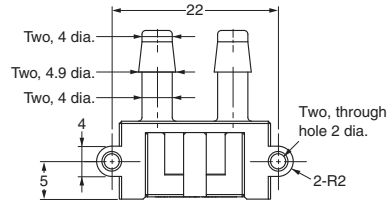
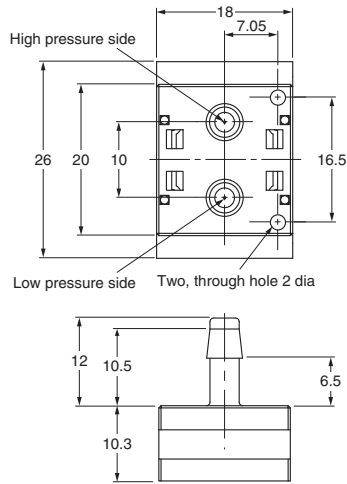
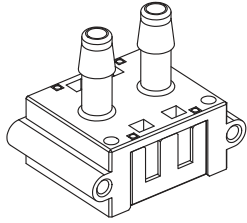

Label: Gives model and lot numbers.

CAD Data

D6F-PH0025AMD2
D6F-PH0505AMD4
D6F-PH5050AMD4

Note: 1. Use M3 screws (round head screws) or tapping screws as the installation screws, and tighten the screws to a maximum torque of 1.0 N·m.

Note: 2. The outer diameter of screw heads and washers must be 6 mm or less.

Note: 3. The sealing part of the inlet port must have a 7.0-dia. ditch and P4 O-ring. (Compliant with JIS B 2401)

Note: 4. Use the following connectors to connect to the Sensor.

Connector : GHR-04V-S (made by J.S.T. Mfg. Co.)

Terminals : SSSL-002T-P0.2 (made by J.S.T. Mfg. Co.)

Wires : AWG26 to AWG30

Recommended Installation Dimensions

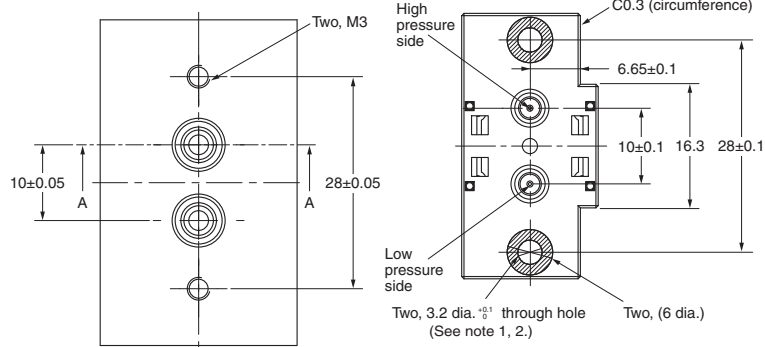
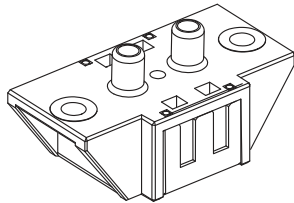

A-A inlet port Recommended dimensions of O-ring sealing surface (See note.3)

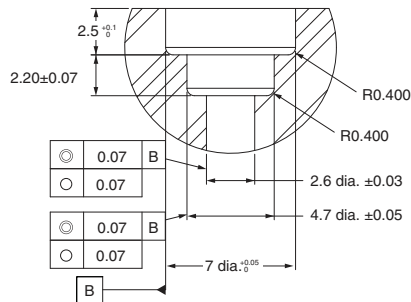

Label: Gives model and lot numbers.

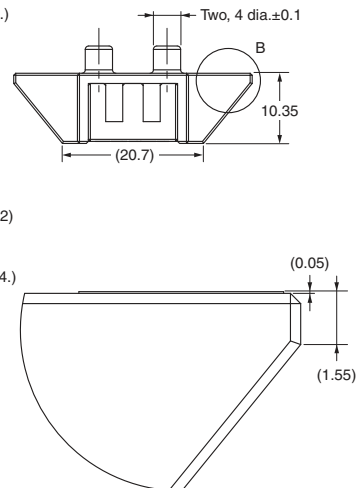
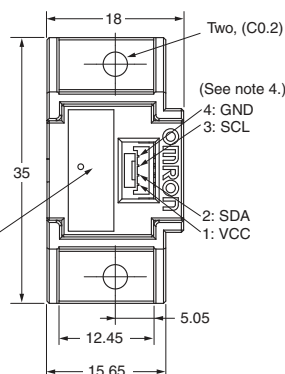
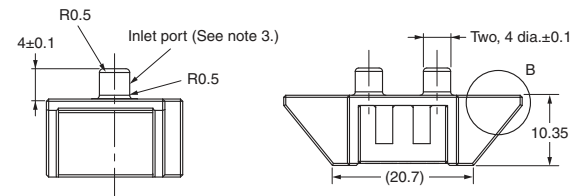

Detailed View of B
 Scale 10:1

CAD Data

Electrical connection

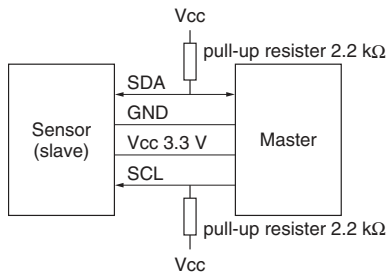

Communication

Serial Interface		I2C
Slave address	HEX	0x6C
	BIN (7bit)	0b110_1100
Speed mode		Max. 400kHz (Fast Mode)
Signal	SCL	Serial Clock
	SDA	Data Signal

D6F-W

MEMS Flow Sensor

A Compact Sensor That Uses OMRON's Unique Flow Path Structure for High-Performance Flow Velocity* Measurement.

Air Analog

- Anti-dust performance enhanced by OMRON's unique three-dimensional flow path structure.
- High accuracy of $\pm 5\%$ FS.

* The flow velocity is the value calculated from the mass flow rate in OMRON's specified wind tunnel. It does not indicate the flow velocity determined by the Measurement Law of JAPAN.



RoHS Compliant



Refer to the *Common Precautions for the D6F Series* on page 39.

Ordering Information

MEMS Flow Sensor

Applicable fluid	Flow rate range	Model
Air	0 to 1 m/s	D6F-W01A1
	0 to 4 m/s	D6F-W04A1
	0 to 10 m/s	D6F-W10A1

Accessory (Sold separately)

Type	Model
Cable	D6F-W CABLE
	D6F-W CABLE-L

Note: Refer to *Accessories for the D6F Series* on page 38.

Connections

D6F-W01A1
D6F-W04A1
D6F-W10A1

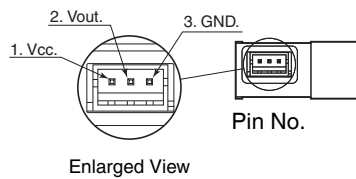

Pin No. 1: Vcc
2: Vout
3: GND
Connector S3B-ZR-SM2-TF
(made by J.S.T. Mfg. Co.)

Use the following connectors from J.S.T. Mfg. Co. Ltd. to connect the D6F:

Housing: ZHR-3

Contacts: SZH-002T-P0.5
Wires: AWG28 to AWG26
Or

Contacts: SZH-003T-P0.5
Wires: AWG32 to AWG28

Output Voltage Characteristics

D6F-W01A1

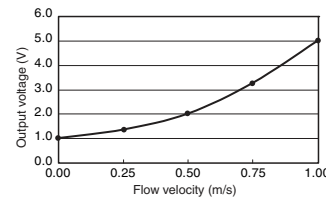

D6F-W04A1

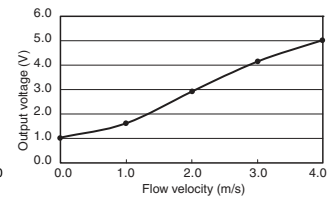

D6F-W10A1

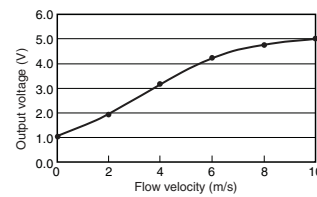

D6F-W01A1

Flow velocity m/s	0	0.25	0.50	0.75	1.00
Output voltage V	1.00 \pm 0.2	1.35 \pm 0.2	2.01 \pm 0.2	3.27 \pm 0.2	5.00 \pm 0.2

D6F-W04A1

Flow velocity m/s	0	1.0	2.0	3.0	4.0
Output voltage V	1.00 \pm 0.2	1.58 \pm 0.2	2.88 \pm 0.2	4.11 \pm 0.2	5.00 \pm 0.2

The flow velocity is the value calculated from the mass flow rate in OMRON's specified 48-mm-dia. wind tunnel. It does not indicate the flow velocity determined by the Measurement Law of Japan. The wind tunnel conditions are shown in *Figure 1*, below.

Figure 1: Wind Tunnel

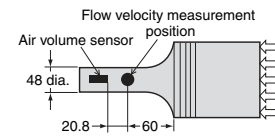

Measurement conditions: Power supply voltage of 12 VDC, ambient temperature of 25°C, and ambient humidity of 35% to 75%.

D6F-W10A1

Flow velocity m/s	0	2.0	4.0	6.0	8.0	10.0
Output voltage V	1.00 \pm 0.24	1.94 \pm 0.24	3.23 \pm 0.24	4.25 \pm 0.24	4.73 \pm 0.24	5.00 \pm 0.24

The flow velocity is the value calculated from the mass flow rate in OMRON's specified 155-mm-dia. wind tunnel. It does not indicate the flow velocity determined by the Measurement Law of Japan. The wind tunnel conditions are shown in *Figure 2*, below.

Figure 2: Wind Tunnel

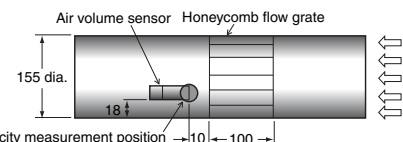

Measurement conditions: Power supply voltage of 12 VDC and ambient temperature of 25°C

Characteristics/Performance

Model	D6F-W01A1	D6F-W04A1	D6F-W10A1
Flow Range (See note 1.)	0 to 1 m/s	0 to 4 m/s	0 to 10 m/s
Calibration Gas (See note 2.)	Air		
Electrical Connection	Three-pin connector		
Power Supply	10.8 to 26.4 VDC		
Current Consumption	15 mA max. with no load, with a Vcc of 12 to 24 VDC, and at 25°C		
Output Voltage	1 to 5 VDC (non-linear output, load resistance of 10 kΩ)		
Accuracy	±5% FS (25°C characteristic)		±6% FS (25°C characteristic)
Repeatability (See note 3.)	±0.4% FS		
Output Voltage (Max.)	5.7 VDC (Load resistance: 10 kΩ)		
Output Voltage (Min.)	0 VDC (Load resistance: 10 kΩ)		
Rated Power Supply Voltage	26.4 VDC		
Rated Output Voltage	6 VDC		
Case	PPS		
Degree of Protection	IEC IP40 (except for flow inlet and outlet)		
Operating Temperature (See note 4.)	-10 to 60°C		
Operating Humidity (See note 4.)	35% to 85%		
Storage Temperature (See note 4.)	-40 to 80°C		
Storage Humidity (See note 4.)	35% to 85%		
Temperature Characteristics	±5% FS for 25°C characteristic at an ambient temperature of -10 to 60°C		
Insulation Resistance	Between sensor outer cover and lead terminals: 20 MΩ min. (at 500 VDC)		
Dielectric Strength	Between sensor outer cover and lead terminals: 500 VAC, 50/60 Hz min. for 1 min (leakage current: 1 mA max.)		
Weight	6.3 g		

Note: 1. Volumetric flow rate at 25°C, 101.3 kPa.

Note: 2. Dry gas. (must not contain large particles, e.g., dust, oil, or mist.)

Note: 3. Reference (typical)

Note: 4. With no condensation or icing.

Dimensions

[CAD Data](#) Please visit our CAD Data website, which is noted on the last page.

(Unit: mm)

MEMS Flow Sensors

D6F-W01A1

D6F-W04A1

D6F-W10A1

[CAD Data](#)

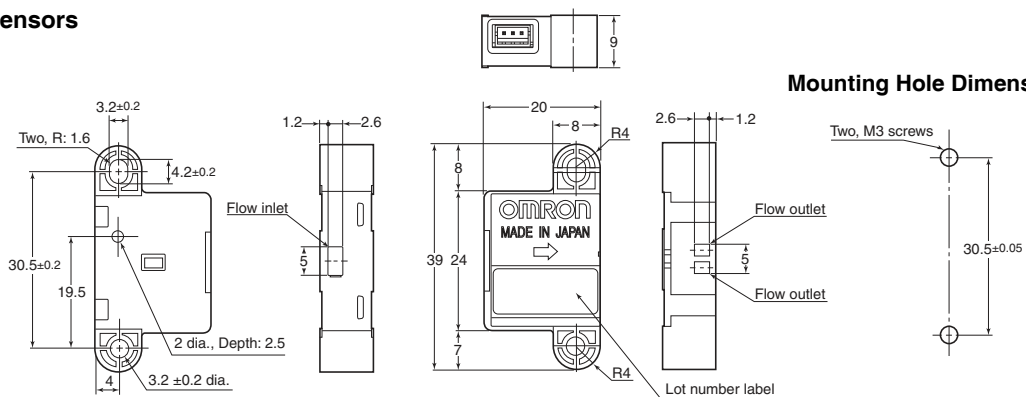

D6F-V

MEMS Flow Sensor

A Compact Sensor That Uses OMRON's Unique Flow Path Structure for High-Performance Flow Velocity* Measurement.

Air Analog



- Anti-dust performance enhanced by OMRON's unique three-dimensional flow path structure.
- Extremely compact, measuring only 24 × 14 × 8 mm.

* The flow velocity is the value calculated from the mass flow rate in OMRON's specified wind tunnel. It does not indicate the flow velocity determined by the Measurement Law of JAPAN.

RoHS Compliant



Refer to the *Common Precautions for the D6F Series* on page 39.

Ordering Information

MEMS Flow Sensor

Applicable fluid	Flow velocity range	Model
Air	0 to 3 m/s	D6F-V03A1

Accessory (Sold separately)

Type	Model
Cable	D6F-CABLE2
	D6F-CABLE2-L

Note: Refer to *Accessories for the D6F Series* on page 38.

Connections

D6F-V03A1

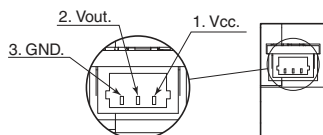

Enlarged View

Pin No. 1: Vcc
2: Vout
3: GND

Connector SM03B-SRSS-TB (made by J.S.T. Mfg. Co.)

Use the following connectors from J.S.T. Mfg. Co. Ltd. to connect the D6F:

- Pressure-welded Connectors
Socket: 03SR-3S
Wires: AWG30
Or
- Crimp Connectors
Contact: SSH-003T-P0.2
Housing: SHR-03V-S
- Wires: AWG32 to AWG28

Output Voltage Characteristics

D6F-V03A1

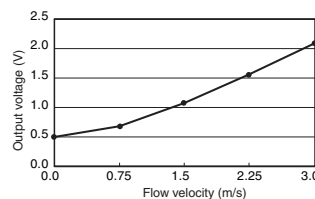

D6F-V03A1

Flow velocity m/s	0	0.75	1.5	2.25	3
Output voltage V	0.5±0.15	0.7±0.15	1.11±0.15	1.58±0.15	2±0.15

The flow velocity is the value calculated from the mass flow rate in OMRON's specified 48-mm-dia. wind tunnel. It does not indicate the flow velocity determined by the Measurement Law of Japan. The wind tunnel conditions are shown in Figure 1 below.

Figure 1: Wind Tunnel

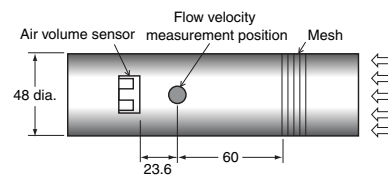

Measurement conditions: Power supply voltage of 3.3 VDC, ambient temperature of 25°C, and dry air.

Characteristics/Performance

Model	D6F-V03A1
Flow Range (See note 1.)	0 to 3 m/s
Calibration Gas (See note 2.)	Air
Electrical Connection	Three-pin connector
Power Supply	3.15 to 3.45 VDC
Current Consumption	15 mA max. with no load, with a Vcc of 3.3 VDC, and at 25°C
Output Voltage	0.5 to 2 VDC (non-linear output, load resistance of 10 kΩ)
Accuracy	±10% FS (25°C characteristic)
Repeatability (See note 3.)	±1.5% FS
Output Voltage (Max.)	2.7 VDC (Load resistance: 10 kΩ)
Output Voltage (Min.)	0 VDC (Load resistance: 10 kΩ)
Rated Power Supply Voltage	12 VDC
Rated Output Voltage	3 VDC
Case	PBT
Degree of Protection	IEC IP40 (except for flow inlet and outlet)
Operating Temperature (See note 4.)	-10 to 60°C
Operating Humidity (See note 4.)	35% to 85%
Storage Temperature (See note 4.)	-40 to 80°C
Storage Humidity (See note 4.)	35% to 85%
Temperature Characteristics	±20% FS for 25°C characteristic at an ambient temperature of -10 to 60°C
Insulation Resistance	Between sensor outer cover and lead terminals: 20 MΩ min. (at 500 VDC)
Dielectric Strength	Between sensor outer cover and lead terminals: 500 VAC, 50/60 Hz min. for 1 min (leakage current: 1 mA max.)
Weight	5.3 g

Note: 1. Volumetric flow rate at 25°C, 101.3 kPa.

Note: 2. Dry gas. (must not contain large particles, e.g., dust, oil, or mist.)

Note: 3. Reference (typical)

Note: 4. With no condensation or icing.

Dimensions

CAD Data Please visit our CAD Data website, which is noted on the last page.

(Unit: mm)

MEMS Flow Sensors D6F-V03A1

CAD Data

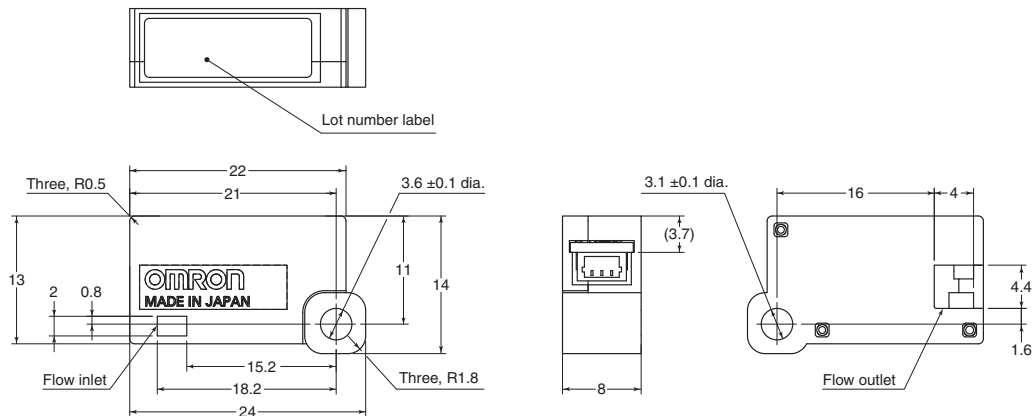

Accessories for the D6F Series

Dimensions

CAD Data Please visit our CAD Data website, which is noted on the last page.

(Unit: mm)

● Cable (Sold separately)

D6F-CABLE1

CAD Data

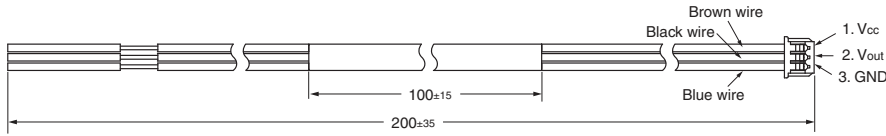

Connector :51021 (Manufactured by Molex, LLC)
Terminal :50079 (Manufactured by Molex, LLC)
Wire :.014SQ

D6F-CABLE2

CAD Data

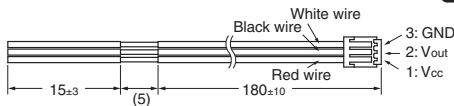

Contact :SSH-003T-P0.2 (Manufactured by J.S.T. Mfg. Co., Ltd.)
Housing :SHR-03V-S (Manufactured by J.S.T. Mfg. Co., Ltd.)
Wire :AWG#30

D6F-CABLE2-L

CAD Data

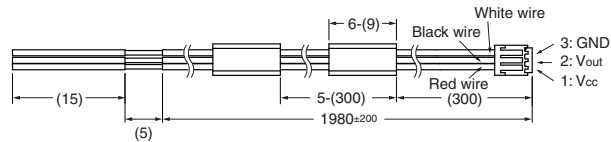

Contact :SSH-003T-P0.2 (Manufactured by J.S.T. Mfg. Co., Ltd.)
Housing :SHR-03V-S (Manufactured by J.S.T. Mfg. Co., Ltd.)
Wire :AWG#30

D6F-CABLE3

CAD Data

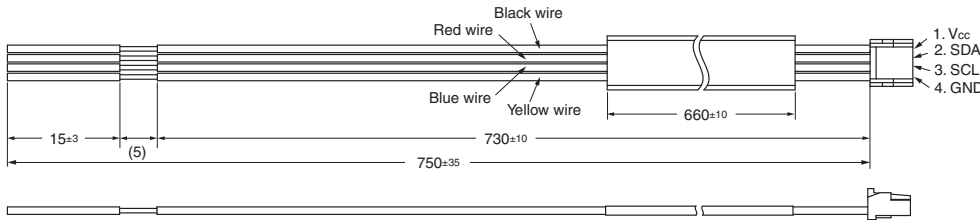

Contact :SSHL-002T-P0.2 (Manufactured by J.S.T. Mfg. Co., Ltd.)
Housing :GHR-04V-S (Manufactured by J.S.T. Mfg. Co., Ltd.)
Wire :AWG#28

D6F-W CABLE

CAD Data

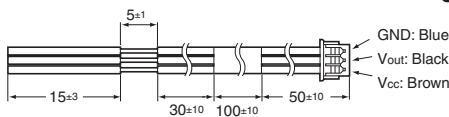

Contact :SZH-002T-P0.5 (Manufactured by J.S.T. Mfg. Co., Ltd.)
Housing :ZHR-3 (Manufactured by J.S.T. Mfg. Co., Ltd.)
Wire :AWG#26

D6F-W CABLE-L

CAD Data

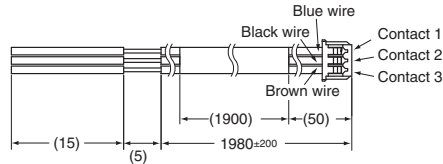

Contact :SZH-002T-P0.5 (Manufactured by J.S.T. Mfg. Co., Ltd.)
Housing :ZHR-3 (Manufactured by J.S.T. Mfg. Co., Ltd.)
Wire :AWG#26

● Quick fastener (Sold separately)

D6F-FASTENER-P10 (for P10)

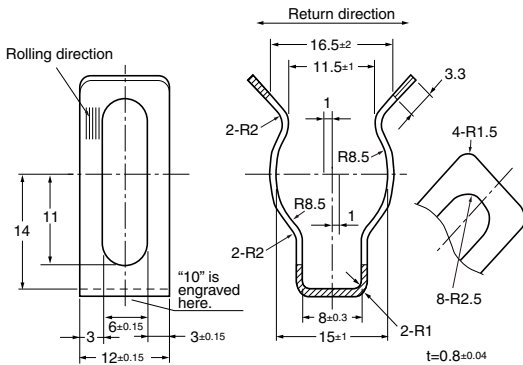

CAD Data

● Pipe fittings (Sold separately)

D6F-PLG1 (for P10)

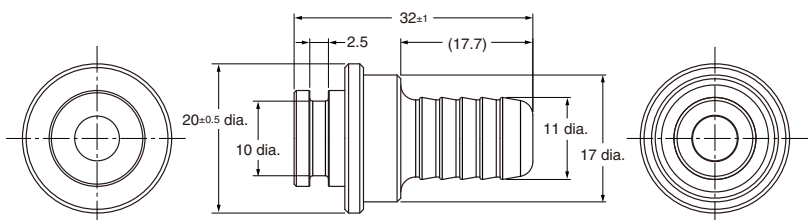

CAD Data

Common Precautions for the D6F Series

Safety Precautions

Precautions for Correct Use

● Sensor Applications

The D6F is built for use with general-purpose devices. In particular, when using the D6F for applications with the safety requirements described below, take steps to ensure system and device safety through measures such as fail-safe designs, redundant designs, and regular inspections.

- Safety devices for ensuring safety for persons
- Transportation equipment control (such as applications to stop operation)
- Aviation and space equipment
- Nuclear power equipment

Do not use the D6F for applications in which D6F operation would directly affect human life.

● Fluids, Pipe Mounting and Sensor Installation

All D6F Models

- (1) Use clean fluids. Install a filter or mist separator on the inflow pipe. Failure to do so may result in malfunction or changes in characteristics due to dust or mist. This does not apply to the D6F-W, D6F-V, D6F-P and D6F-PH.
- (2) Do not use corrosive gases other than the specified applicable fluids (such as chlorine, sulfur, acid, or alkali). Doing so may cause product failure.
- (3) The specified performance may not be obtained if the D6F is used for fluids other than the specified applicable fluids.
- (4) After removing the Sensor from the package, do not allow foreign particles to enter the piping. Foreign particles in the piping may cause product failure.
- (5) Install the sensor so that the fluid flows in the direction indicated by the arrow on the Sensor. Correct measurements cannot be obtained if the fluid flows in the wrong direction. This does not apply to the D6F-V, D6F-P and D6F-PH.
- (6) It is recommended that the Sensor (except for the D6F-A3) be mounted horizontally. If it is not mounted horizontally, an error of $\pm 1\%$ FS or higher may result.
- (7) Install the Sensor on a flat surface. Incorrect installation may damage the Sensor and make it impossible to obtain correct measurements.
- (8) Make sure that the power to all equipment is turned OFF before you install the Sensor. Installing the Sensor while the power supply is ON may result in electrical shock or abnormal operation.
- (9) Always check operation after installation.
- (10) Do not drop the Sensor or disassemble the cover.

D6F-A1

- (1) Make sure that pipes with bamboo joints are airtight. Correct measurements cannot be obtained if there is leakage from joints.
- (2) Use M3 panhead screws to install the Sensor, and tighten them to a maximum torque of 0.59 N•m.

D6F-N2/-L2

- (1) Use the Rc 1/4 tapped threads for the pipes, and tighten the threads to a maximum torque of 5 N•m. Tightening beyond this value may result in fractures, which can cause leaks. Apply a suitable amount of pipe sealer. Do not apply sealer on the first two threads from the end of the threaded section. When you tighten the pipes, do not allow foreign matter or oil on the joint area.
- (2) Use M3 panhead screws to install the Sensor, and tighten them to a maximum torque of 0.59 N•m.

D6F-A3

- (1) When installing the pipes, use M5 screws for the joints and tighten to a torque of 1.5 N•m maximum. Use sealing tape to make the joints airtight. Incorrect installation may make it impossible to obtain correct measurements.
- (2) It is recommended that the Sensor be mounted either horizontally or vertically. Mounting the Sensor at an angle may make it impossible to obtain correct measurements.
- (3) Use M3 panhead screws to install the Sensor, and tighten them to a maximum torque of 0.59 N•m.

D6F-A5

- (1) Use M3 panhead screws to install the Sensor, and tighten them to a maximum torque of 0.59 N•m.
- (2) Install O-rings to seal the fluid inlet and outlet points. The recommended O-ring is JIS B 2401, nominal number P5.

Installation Example

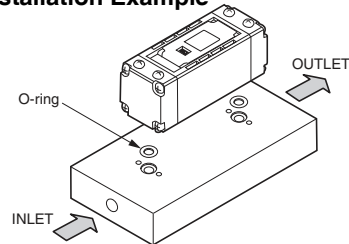

D6F-A6

- (1) Use the appropriate threads (R1/4, NPT1/8 or NPT1/2) for the pipes, and tighten the pipes to a maximum torque of 5 N•m. Tightening beyond this value may result in fractures, which can cause leaks. When you tighten the pipes, do not allow foreign matter or oil on the joint area. Use a spanner or adjustable wrench to turn the connecting section (aluminum alloy) and connect the pipe. Do not place the spanner or wrench on the Sensor (PPS). Doing so may damage the Sensor or result in leaks. Apply a suitable amount of pipe sealer. Do not apply sealer on the first two threads from the end of the threaded section. When you tighten the pipes, do not allow foreign matter or oil on the joint area.
- (2) Use M3 panhead screws to install the Sensor, and tighten them to a maximum torque of 0.59 N•m.

Common Precautions for the D6F Series

D6F-A7/-L7/-N7/-A7D/-AB71/-AB71D

- (1) Use male quick couplings for the piping, and secure them with the applicable quick fasteners.
- (2) Do not apply excessive force to the adapter section when connecting the pipes. If strong force is applied to the connected pipes, or if strong force is applied directly to the adapter section while holding the Sensor, it may damage the Sensor or cause leakage.

Installation Example

Use male, P10-type quick-connect joints for the D6F-A7/-L7/-N7/-A7D and P14-type quick-connect joints for the D6F-AB71/-AB71D.

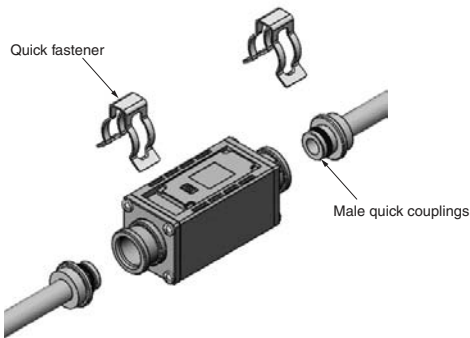

Applicable male quick coupling dimensions (Unit: mm)

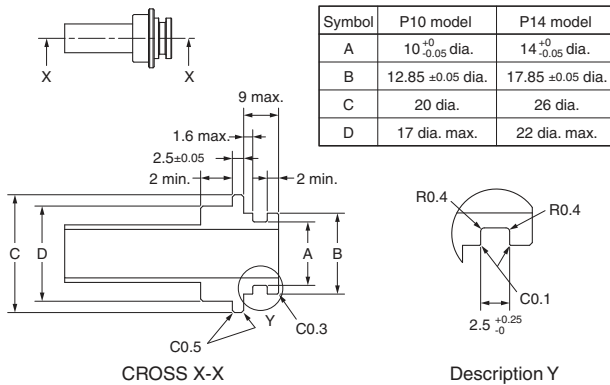

Note. There is a possibility that leak damage or faulty of the body occurs when static load of more than 40 N is applied to 300 mm from the center of product as fulcrum point.

D6F-P0001A1/-P0010A1/-P0010A2

- (1) Depending on the ambient environment and installation location, dust, dirt, and other foreign matter may come in inside the Sensor and block a part or all of the flow path or accumulate on internal components. This may result in the Sensor not being able to perform to the specifications given above. Always perform a pre-evaluation on your actual equipment and be aware of the possible problems that may occur before you use the Sensor with the actual equipment.
- (2) Attach all tubes so that the fluid flows only in the direction from the positive side (+) to the negative side (-). Refer to the figure on page 26 for the installation direction.
- (3) For PCB-mounting Sensors, perform terminal soldering only after the Sensor is secured into place on the PCB. Use a soldering iron for 5 s at 350°C with a pressure of 100 gf max. (This applies only to PCB-mounting Sensors.)
- (4) Use M2.6 panhead screws or equivalent tapping screws to mount the Sensor, and tighten the screws to a maximum torque of 0.59 N•m.

D6F-P0010AM2

- (1) Depending on the ambient environment and installation location, dust, dirt, and other foreign matter may come in inside the Sensor and block a part or all of the flow path or accumulate on internal components. This may result in the Sensor not being able to perform to the specifications given above. Always perform a pre-evaluation on your actual equipment and be aware of the possible problems that may occur before you use the Sensor with the actual equipment.
- (2) Attach all tubes so that the fluid flows only in the direction from the positive side (+) to the negative side (-). Install the Sensor with the manifold facing downward. Refer to the figure on page 26 for the installation direction.
- (3) Use M3 panhead screws or equivalent tapping screws to mount the Sensor, and tighten the screws to a maximum torque of 0.59 N•m.
- (4) Install O-rings to seal the fluid inlet and outlet points. The recommended O-ring is JIS B 2401, nominal number P4.

Installation Example

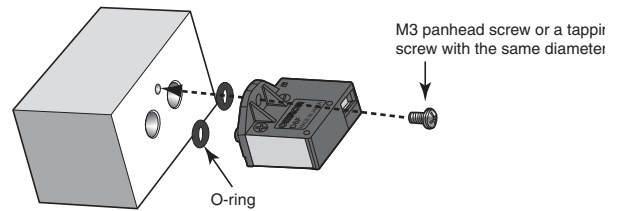

D6F-PHAD1/-PHAD2/-PHAD3/-PHAD4

- (1) Depending on the ambient environment and installation location, dust, dirt, and other foreign matter may come in inside the Sensor and block a part or all of the flow path or accumulate on internal components. This may result in the Sensor not being able to perform to the specifications given above. Always perform a pre-evaluation on your actual equipment and be aware of the possible problems that may occur before you use the Sensor with the actual equipment.
- (2) Attach all tubes so that the fluid flows only in the direction from the high pressure side (+) to the low pressure side (-).
- (3) Use M1.8 panhead screws or equivalent tapping screws to mount the Sensor, and tighten the screws to a maximum torque of 0.36 N•m.
- (4) The sensor output is affected with the length of a tube. The error is less than 1% with a tube (ID:4mm) length up to 800mm.
- (5) Connection (D6F-PHAD1/-PHAD3)
 - Wire with the correct terminal names and polarities. Incorrect wiring will cause failure of internal components.
 - Do not use flow soldering.
 - Please solder after fixed on the circuit board by screw.
 - Use a soldering iron:
 - Soldering condition Pressure Max.100gf
 - Temperature 350 degree C
 - Time Max. 5s

Common Precautions for the D6F Series

D6F-PHAMD2/-PHAMD4

- (1) Depending on the ambient environment and installation location, dust, dirt, and other foreign matter may come in inside the Sensor and block a part or all of the flow path or accumulate on internal components. This may result in the Sensor not being able to perform to the specifications given above. Always perform a pre-evaluation on your actual equipment and be aware of the possible problems that may occur before you use the Sensor with the actual equipment.
- (2) Attach all tubes so that the fluid flows only in the direction from the high pressure side (+) to the low pressure side (-).
- (3) Use M3 screws (round head screws) to install the Sensor, and tighten them to a maximum torque of 1.0 N•m. The outer diameter of screw heads and washers must be 6 mm or less. Check that the Sensor is securely fastened by the screws.
- (4) Seal the sealing part of the inlet port with an O-ring. The recommended O-ring is JIS B 2401, nominal number P4.

D6F-W

- (1) Depending on the ambient environment and installation location, dust, dirt, and other foreign matter may come in inside the Sensor and block a part or all of the flow path or accumulate on internal components. This may result in the Sensor not being able to perform to the specifications given above. Always perform a pre-evaluation on your actual equipment and be aware of the possible problems that may occur before you use the Sensor with the actual equipment.
- (2) Use M3 panhead screws to install the Sensor, and tighten them to a maximum torque of 0.59 N•m.

D6F-V

- (1) Depending on the ambient environment and installation location, dust, dirt, and other foreign matter may come in inside the Sensor and block a part or all of the flow path or accumulate on internal components. This may result in the Sensor not being able to perform to the specifications given above. Always perform a pre-evaluation on your actual equipment and be aware of the possible problems that may occur before you use the Sensor with the actual equipment.
- (2) Use M3 panhead screws to install the Sensor, and tighten them to a maximum torque of 0.59 N•m.
- (3) This Sensor does not contain any protective circuits. Never allow the electrical load to exceed the maximum ratings. Doing so may damage the circuits. Install protective circuits if required.
- (4) Mount the Sensor so that the flow inlet side (the side with the logo) is perpendicular to the windward side and ensure that the flow inlet and flow outlet are not blocked in any way. If the Sensor is not mounted correctly, accurate measurements cannot be made.

Installation Example

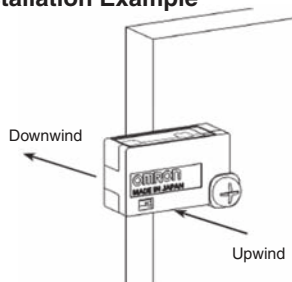

● Operating Environment

Do not use the Sensor in the following locations:

- Locations directly subject to heat radiated from heating equipment
- Locations subject to water or oil
- Locations subject to direct sunlight
- Locations subject to intense temperature changes
- Locations subject to icing or condensation
- Locations subject to excessive vibration or shock

● Countermeasures against Noise

Noise may make it impossible to obtain correct measurements. Consider the following countermeasures.

- Allow as much space as possible between the Sensor and devices that generates high frequencies (such as high-frequency welders and high-frequency sewing machines) or surges.
- Attach surge absorbers or noise filters to noise-generating devices that are near the Sensor (in particular, equipment with inductance, such as motors, transformers, solenoids, and magnetic coils).
(It also helps to separate pipes and ducts, and to use shielded cables.)

● Power Supply

- Force of connector terminal is 20 N max. Do not add strength more than tension of wire bending to connector at wiring. Install the connector coaxially to the fitting axis with holding all wires. And pulling angle should be within 15 degrees.
- Use the applicable connectors. Directly soldering the connection terminals will cause product failure. (except for the D6F-PH)
- Check the terminal names and polarity and wire the power supply correctly. Incorrect wiring will cause failure of internal components.
- When using a commercially available switching regulator, ground the FG (frame ground) and G (ground) terminals.

● Handling

The sensor is a precision device, and if large shock and load is applied, it may cause a failure or characteristic change. Do not drop it, disassemble it, or apply force to the terminals more than necessary. And please do not use dropped product.

- The sensor shall only be handled in electrostatic discharge protected areas (EPA) under protected and controlled conditions

RoHS Directive

The RoHS mark is displayed on the packing of products for which the six substances banned by the RoHS Directive have been abolished (both in processing and in the electronic components mounted to the PCBs).

* RoHS marking may be terminated if it is later determined that parts that were previously treated as RoHS compliant are not compliant due to circumstances at the supplier of the parts.

● RoHS Compliance Criteria

The following standards are used to determine RoHS compliance for the six banned substances.

(Items to which the RoHS Directive is not applicable are not given.)

- Lead: 1,000 ppm max.
- Hexavalent chromium: 1,000 ppm max.
- Mercury: 1,000 ppm max.
- PBB: 1,000 ppm max.
- Cadmium: 100 ppm max.
- PBDE: 1,000 ppm max.

For correct way of use, please check respective User's Manuals below.

- 1) MEMS Flow Sensor D6F Series User's Manual (Manual No. A286-E1)
- 2) MEMS Flow Sensor D6F-A7D/-AB71D User's Manual (Manual No. A302-E1)
- 3) MEMS Flow Sensor D6F-P User's Manual (Manual No. A299-E1)
- 4) MEMS Flow Sensor D6F-W/D6F-V User's Manual (Manual No. A300-E1)
- 5) MEMS Flow Sensor D6F-PH User's Manual (Manual No. A288-E1)

Please check each region's Terms & Conditions by region website.

OMRON Corporation

Electronic and Mechanical Components Company

Regional Contact

Americas

<https://www.components.omron.com/>

Asia-Pacific

<https://ecb.omron.com.sg/>

Korea

<https://www.omron-ecb.co.kr/>

Europe

<http://components.omron.eu/>

China

<https://www.ecb.omron.com.cn/>

Japan

<https://www.omron.co.jp/ecb/>