

RIF-1-RSC-LV-230AC/2X21 - Relay Module



2903347

<https://www.phoenixcontact.com/us/products/2903347>

Please be informed that the data shown in this PDF document is generated from our online catalog. Please find the complete data in the user documentation. Our general terms of use for downloads are valid.



Preassembled relay module with screw connection, consisting of: relay base, power contact relay, plug-in display/interference suppression module, and retaining bracket. Contact switching type: 2 changeover contacts. Input voltage: 230 V AC

Product description

The pluggable electromechanical and solid-state relays in the RIFLINE complete product range and the base are recognized and approved in accordance with UL 508. The relevant approvals can be called up at the individual components in question.

Commercial data

Item number	2903347
Packing unit	1 pc
Minimum order quantity	10 pc
Sales key	C465
Product key	CK6519
Catalog page	Page 329 (C-5-2019)
GTIN	4046356732819
Weight per piece (including packing)	69 g
Weight per piece (excluding packing)	69 g
Customs tariff number	85364900
Country of origin	CN

RIF-1-RSC-LV-230AC/2X21 - Relay Module



2903347

<https://www.phoenixcontact.com/us/products/2903347>

Technical data

Notes

General	FBS 2-6... plug-in bridge for the input side (A2) and FBS-2-8... plug-in bridge for the output side (11/21)
---------	---

Product properties

Product type	Relay Module
Product family	RIFLINE complete
Application	Universal
Operating mode	100% operating factor
Mechanical service life	approx. 10^7 cycles

Insulation characteristics

Insulation	Safe isolation between input and output
	Basic insulation between the changeover contacts

Insulation characteristics

Insulation	Safe isolation between input and output
	Basic insulation between the changeover contacts
Overvoltage category	III
Pollution degree	2

Electrical properties

Service life electrical	see diagram
Maximum power dissipation for nominal condition	1.38 W
Test voltage (Winding/contact)	4 kV _{rms} (50 Hz, 1 min., winding/contact)
Test voltage (Changeover contact/changeover contact)	2.5 kV _{rms} (50 Hz, 1 min., changeover contact/changeover contact)
Rated insulation voltage	250 V AC
Rated surge voltage	6 kV (Input/output)
	4 kV (between the changeover contacts)

Input data

Coil side

Nominal input voltage U_N	230 V AC
Input voltage range	184 V AC ... 264.5 V AC (20 °C)
Input voltage range in reference to U_N	see diagram
Mains frequency	50/60 Hz
Drive and function	monostable
Drive (polarity)	polarized
Typical input current at U_N	6 mA
Typical response time	3 ms ... 12 ms
Typical release time range	3 ms ... 20 ms

RIF-1-RSC-LV-230AC/2X21 - Relay Module



2903347

<https://www.phoenixcontact.com/us/products/2903347>

Coil voltage	230 V AC
Protective circuit	Varistor
Operating voltage display	Yellow LED

Output data

Switching

Contact switching type	2 changeover contacts
Type of switch contact	Single contact
Contact material	AgNi
Maximum switching voltage	250 V AC/DC
Minimum switching voltage	5 V (10 mA)
Limiting continuous current	8 A (see diagram)
Maximum inrush current	12 A (20 ms, N/O contacts)
Min. switching current	10 mA (5 V)
Interrupting rating (ohmic load) max.	192 W (at 24 V DC) 124 W (at 48 V DC) 108 W (at 60 V DC) 52 W (at 110 V DC) 48 W (at 220 V DC) 2500 VA (for 250 V AC)
Utilization category CB Scheme (IEC 60947-5-1)	AC15, 1.5 A/240 V (N/O contact) AC15, 2 A/250 V (N/C contact) DC13, 2 A/24 V (N/C contact) DC13, 0.2 A/250 V (N/O contact)

Connection data

Connection method	Screw connection
Stripping length	8 mm
Conductor cross section rigid	0.5 mm ² ... 4 mm ²
Conductor cross-section rigid (2 conductors with same cross section)	0.5 mm ² ... 2.5 mm ²
Conductor cross section flexible	0.5 mm ² ... 4 mm ² 0.5 mm ² ... 4 mm ² (Ferrule with plastic sleeve)
Conductor cross section flexible (2 conductors with same cross section)	0.5 mm ² ... 2.5 mm ² 0.5 mm ² ... 1.5 mm ² (TWIN ferrule with plastic sleeve)
Conductor cross section AWG	20 ... 10 (solid) 20 ... 12 (flexible)
Tightening torque	0.5 Nm ... 0.6 Nm

Dimensions

Width	16 mm
Height	90 mm
Depth	75 mm

RIF-1-RSC-LV-230AC/2X21 - Relay Module



2903347

<https://www.phoenixcontact.com/us/products/2903347>

Material specifications

Flammability rating according to UL 94	V2 (Housing)
--	--------------

Environmental and real-life conditions

Ambient conditions

Degree of protection (Relay base)	IP20 (Relay base)
Degree of protection (Relay)	RT III (Relay)
Ambient temperature (operation)	-40 °C ... 50 °C
Ambient temperature (storage/transport)	-40 °C ... 85 °C

Approvals

Corrosive gas test

Identification	ISA-S71.04. G3 Harsh Group
	EN 60068-2-60

Standards and regulations

Standards/regulations	IEC 60947-5-1
-----------------------	---------------

Mounting

Mounting type	DIN rail mounting
Assembly instructions	in rows with zero spacing
Mounting position	any

Drawings

Diagram

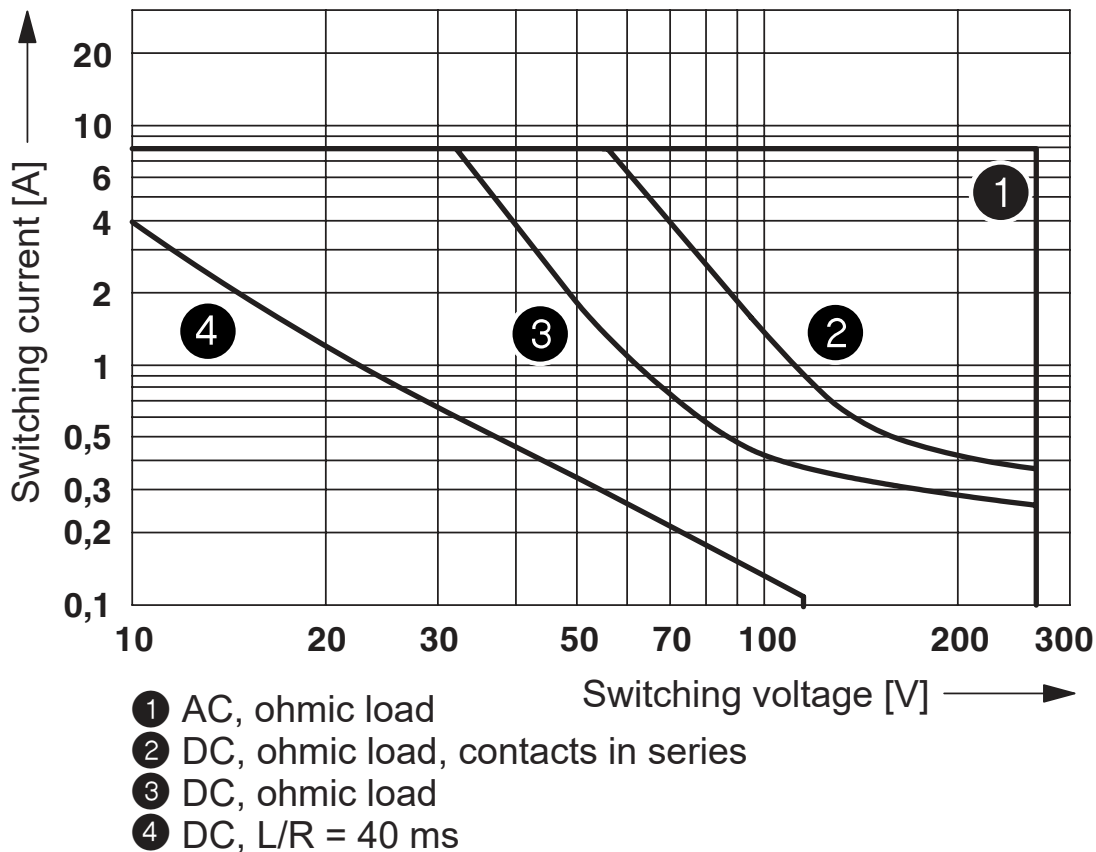

Interrupting rating

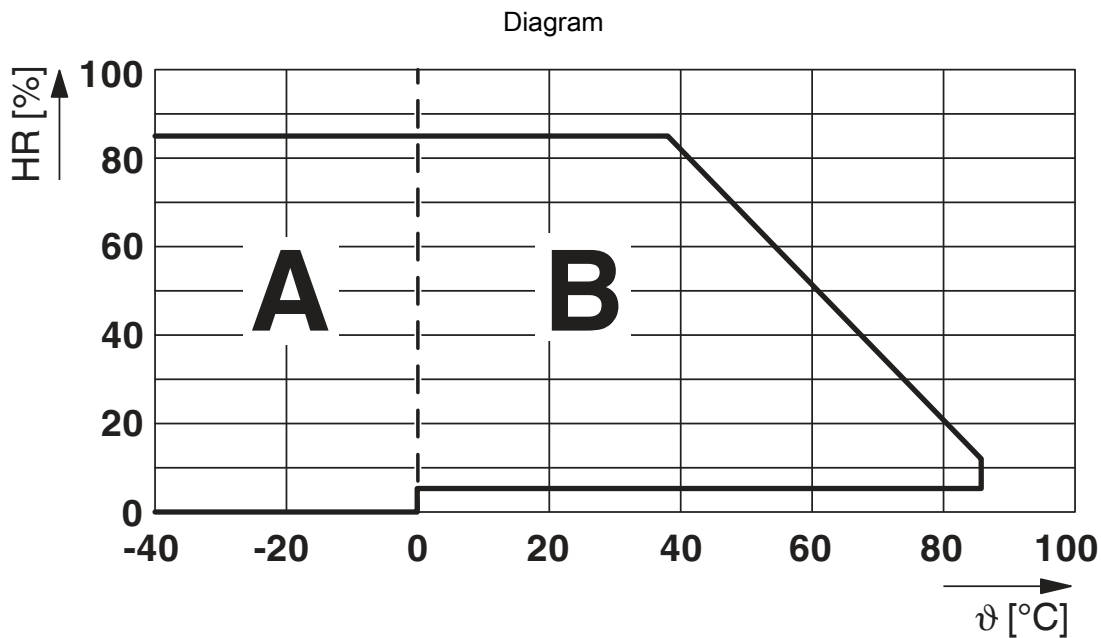

Permissible humidity for operation and storage.

The maximum permissible ambient temperature as specified in the data sheet must be observed.

Area A: Ice buildup at ambient temperatures $\leq 0^\circ\text{C}$ must be prevented

Area B: Condensation at ambient temperatures $> 0^\circ\text{C}$ must be prevented

On 30 full days that are naturally distributed across an entire year, a humidity level of 95% is permissible at an ambient temperature $\leq 25^\circ\text{C}$.

Diagram

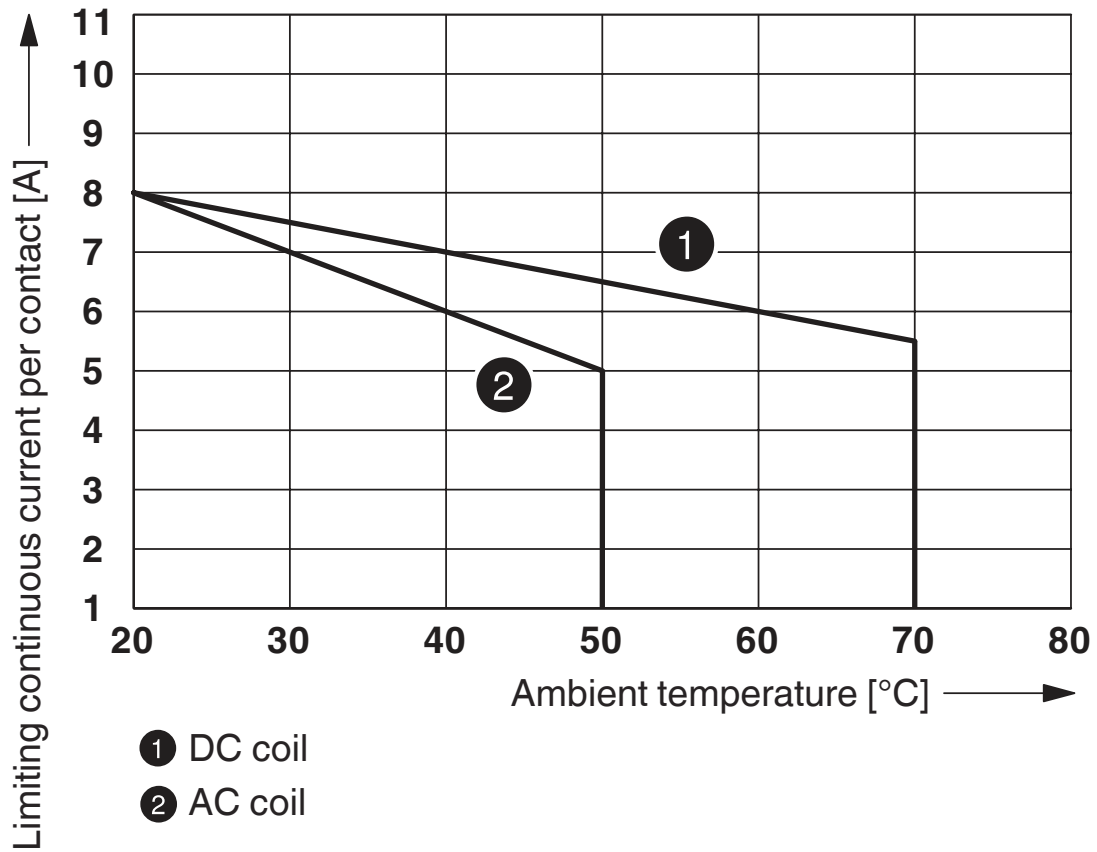

Contact derating

RIF-1-RSC-LV-230AC/2X21 - Relay Module



2903347

<https://www.phoenixcontact.com/us/products/2903347>

Circuit diagram

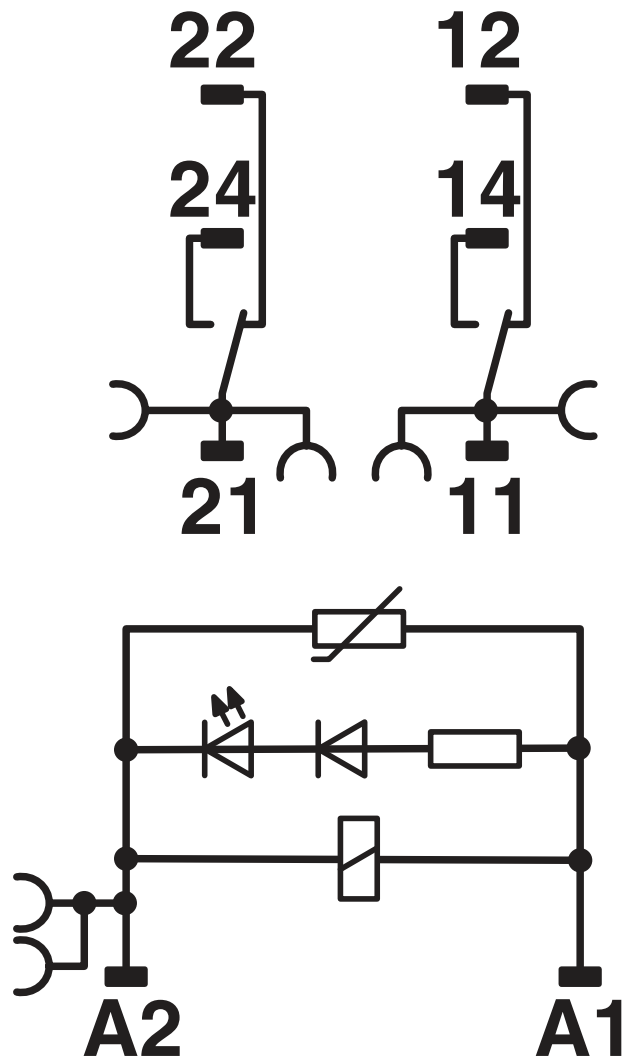

2903347

<https://www.phoenixcontact.com/us/products/2903347>

Diagram

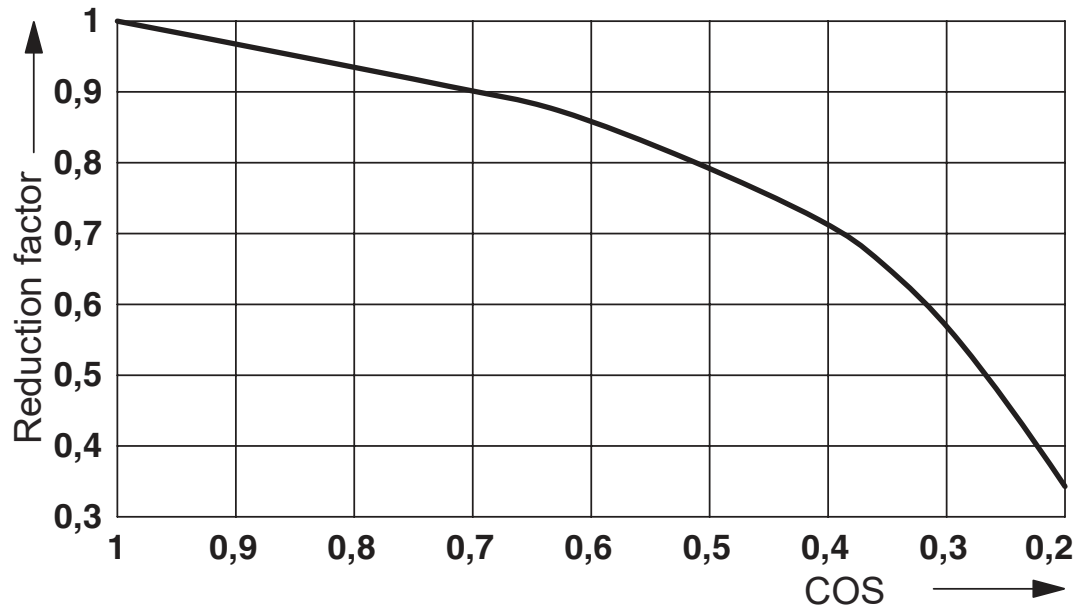

Service life reduction factor

Diagram

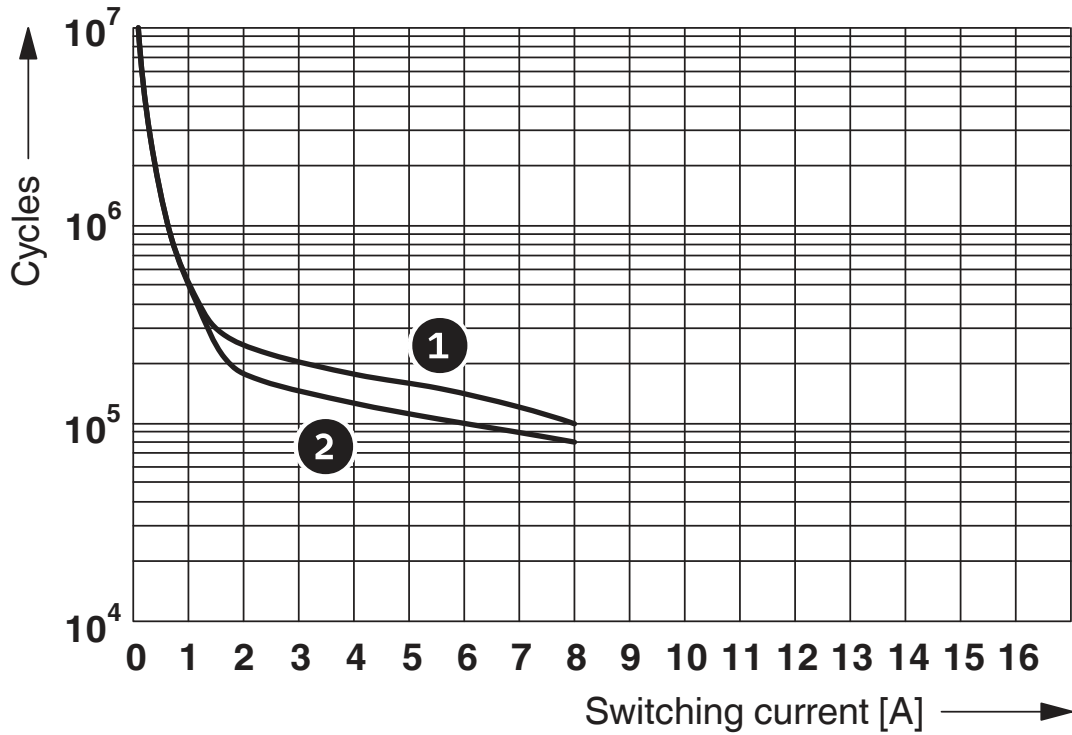

- ① 250 V AC, ohmic load (DC coils)
- ② 250 V AC, ohmic load (AC coils)

Electrical service life

Diagram

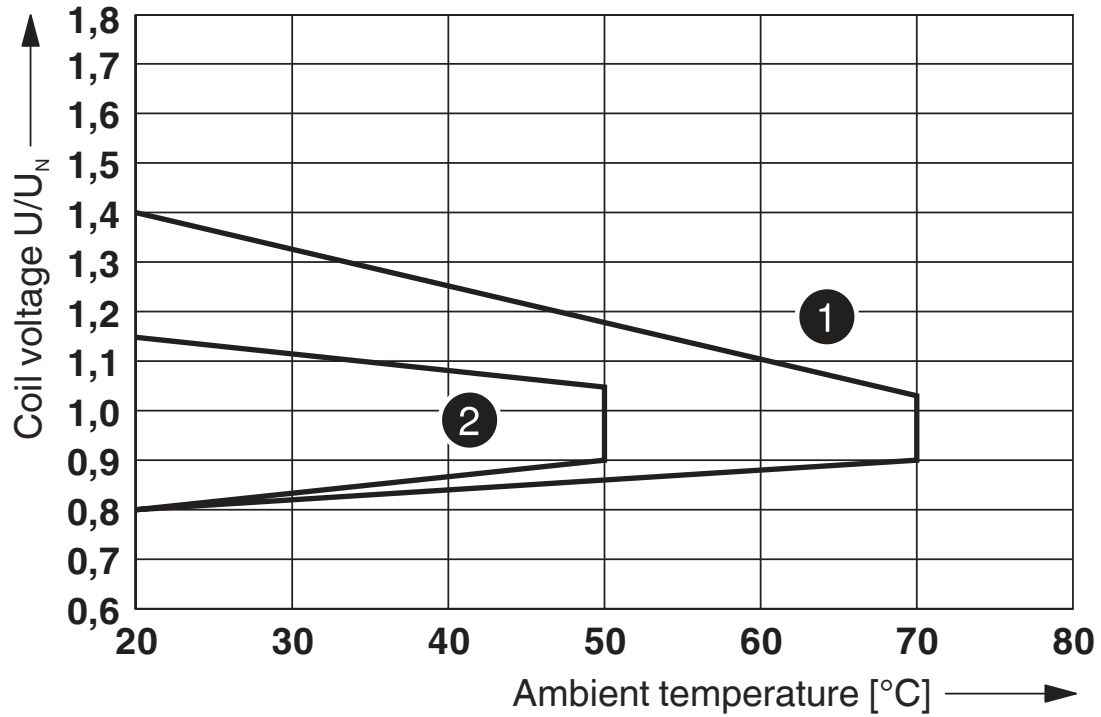

- ① DC coils
- ② AC coils

Operating voltage range

RIF-1-RSC-LV-230AC/2X21 - Relay Module



2903347

<https://www.phoenixcontact.com/us/products/2903347>

Approvals

To download certificates, visit the product detail page: <https://www.phoenixcontact.com/us/products/2903347>



EAC

Approval ID: TR_TS_D_00573_c



DNV GL

Approval ID: TAA000018V



EAC

Approval ID: RU*C-DE.*08.B.00010

RIF-1-RSC-LV-230AC/2X21 - Relay Module



2903347

<https://www.phoenixcontact.com/us/products/2903347>

Classifications

ECLASS

ECLASS-11.0	27371601
ECLASS-12.0	27371601
ECLASS-13.0	27371601

ETIM

ETIM 8.0	EC001437
----------	----------

UNSPSC

UNSPSC 21.0	39122300
-------------	----------

RIF-1-RSC-LV-230AC/2X21 - Relay Module



2903347

<https://www.phoenixcontact.com/us/products/2903347>

Environmental product compliance

REACH SVHC	Lead 7439-92-1
China RoHS	Environmentally Friendly Use Period = 50 years
	For information on hazardous substances, refer to the manufacturer's declaration available under "Downloads"

RIF-1-RSC-LV-230AC/2X21 - Relay Module



2903347

<https://www.phoenixcontact.com/us/products/2903347>

Accessories

FBS 2-6 - Plug-in bridge

3030336

<https://www.phoenixcontact.com/us/products/3030336>



Plug-in bridge, pitch: 6.2 mm, number of positions: 2, color: red

FBS 2-6 BU - Plug-in bridge

3036932

<https://www.phoenixcontact.com/us/products/3036932>



Plug-in bridge, pitch: 6.2 mm, number of positions: 2, color: blue

RIF-1-RSC-LV-230AC/2X21 - Relay Module



2903347

<https://www.phoenixcontact.com/us/products/2903347>

FBS 2-6 GY - Plug-in bridge

3032237

<https://www.phoenixcontact.com/us/products/3032237>



Plug-in bridge, pitch: 6.2 mm, number of positions: 2, color: gray

FBS 2-8 - Plug-in bridge

3030284

<https://www.phoenixcontact.com/us/products/3030284>



Plug-in bridge, pitch: 8.2 mm, number of positions: 2, color: red

RIF-1-RSC-LV-230AC/2X21 - Relay Module



2903347

<https://www.phoenixcontact.com/us/products/2903347>

FBS 2-8 BU - Plug-in bridge

3032567

<https://www.phoenixcontact.com/us/products/3032567>



Plug-in bridge, pitch: 8.2 mm, number of positions: 2, color: blue

FBS 2-8 GY

7042 - Plug-in bridge

3032541

<https://www.phoenixcontact.com/us/products/3032541>



Bridge for potential distribution

RIF-1-RSC-LV-230AC/2X21 - Relay Module



2903347

<https://www.phoenixcontact.com/us/products/2903347>

STP 5-2 - Marker carriers

0800967

<https://www.phoenixcontact.com/us/products/0800967>



Marker carriers, snaps into STTB 2,5, STTB 4, PTTB 2,5, and PTTB 4 double-level spring-cage terminal blocks, can be marked with UC-TM 5, UC-TMF 5, UCT-TM 5, UCT-TMF 5, ZB 5, or ZBF 5, gray, unlabeled, mounting type: plug in, lettering field size: 5 x 10.5 mm

NS 35/ 7,5 PERF 2000MM - DIN rail perforated

0801733

<https://www.phoenixcontact.com/us/products/0801733>



DIN rail perforated, acc. to EN 60715, material: Steel, galvanized, passivated with a thick layer, Standard profile, color: silver, Pack of 25 (50 m)

RIF-1-RSC-LV-230AC/2X21 - Relay Module



2903347

<https://www.phoenixcontact.com/us/products/2903347>

NS 35/ 7,5 UNPERF 2000MM - DIN rail, unperforated

0801681

<https://www.phoenixcontact.com/us/products/0801681>



DIN rail, unperforated, acc. to EN 60715, material: Steel, galvanized, passivated with a thick layer, Standard profile, color: silver, Pack of 25 (50 m)

NS 35/ 7,5 WH PERF 2000MM - DIN rail perforated

1204119

<https://www.phoenixcontact.com/us/products/1204119>



DIN rail perforated, acc. to EN 60715, material: Steel, Galvanized, white passivated, Standard profile, color: silver, Pack of 25 (50 m)

RIF-1-RSC-LV-230AC/2X21 - Relay Module



2903347

<https://www.phoenixcontact.com/us/products/2903347>

NS 35/ 7,5 WH UNPERF 2000MM-VPE 10 - DIN rail, unperforated

1204122

<https://www.phoenixcontact.com/us/products/1204122>



DIN rail, unperforated, acc. to EN 60715, material: Steel, Galvanized, white passivated, Standard profile, color: silver, Pack of 10 (20 m)

NS 35/ 7,5 AL UNPERF 2000MM - DIN rail, unperforated

0801704

<https://www.phoenixcontact.com/us/products/0801704>



DIN rail, unperforated, acc. to EN 60715, material: Aluminum, uncoated, Standard profile, color: silver, Pack of 25 (50 m)

RIF-1-RSC-LV-230AC/2X21 - Relay Module



2903347

<https://www.phoenixcontact.com/us/products/2903347>

NS 35/ 7,5 ZN PERF 2000MM - DIN rail perforated

1206421

<https://www.phoenixcontact.com/us/products/1206421>



DIN rail perforated, acc. to EN 60715, material: Steel, galvanized, Standard profile, color: silver, Pack of 25 (50 m)

NS 35/ 7,5 ZN UNPERF 2000MM - DIN rail, unperforated

1206434

<https://www.phoenixcontact.com/us/products/1206434>



DIN rail, unperforated, acc. to EN 60715, material: Steel, galvanized, Standard profile, color: silver, Pack of 25 (50 m)

RIF-1-RSC-LV-230AC/2X21 - Relay Module



2903347

<https://www.phoenixcontact.com/us/products/2903347>

NS 35/ 7,5 CU UNPERF 2000MM-VPE 10 - DIN rail, unperforated

0801762

<https://www.phoenixcontact.com/us/products/0801762>



DIN rail, unperforated, acc. to EN 60715, material: Copper, uncoated, Standard profile, color: copper-colored, Pack of 10 (20 m)

NS 35/ 7,5 CAP - End cap

1206560

<https://www.phoenixcontact.com/us/products/1206560>

DIN rail end piece, for DIN rail NS 35/7.5



RIF-1-RSC-LV-230AC/2X21 - Relay Module



2903347

<https://www.phoenixcontact.com/us/products/2903347>

NS 35/15 PERF 2000MM - DIN rail perforated

1201730

<https://www.phoenixcontact.com/us/products/1201730>



DIN rail perforated, similar to EN 60715, material: Steel, galvanized, passivated with a thick layer, Standard profile, color: silver, Pack of 25 (50 m)

NS 35/15 UNPERF 2000MM - DIN rail, unperforated

1201714

<https://www.phoenixcontact.com/us/products/1201714>



DIN rail, unperforated, similar to EN 60715, material: Steel, galvanized, passivated with a thick layer, Standard profile, color: silver, Pack of 25 (50 m)

RIF-1-RSC-LV-230AC/2X21 - Relay Module



2903347

<https://www.phoenixcontact.com/us/products/2903347>

NS 35/15 WH PERF 2000MM - DIN rail perforated

0806602

<https://www.phoenixcontact.com/us/products/0806602>



DIN rail perforated, similar to EN 60715, material: Steel, Galvanized, white passivated, Standard profile, color: white, Pack of 25 (50 m)

NS 35/15 WH UNPERF 2000MM-VPE 10 - DIN rail, unperforated

1204135

<https://www.phoenixcontact.com/us/products/1204135>



DIN rail, unperforated, similar to EN 60715, material: Steel, Galvanized, white passivated, Standard profile, color: silver, Pack of 10 (20 m)

RIF-1-RSC-LV-230AC/2X21 - Relay Module



2903347

<https://www.phoenixcontact.com/us/products/2903347>

NS 35/15 AL UNPERF 2000MM - DIN rail, unperforated

1201756

<https://www.phoenixcontact.com/us/products/1201756>



DIN rail, unperforated, similar to EN 60715, material: Aluminum, uncoated, Standard profile, color: silver

NS 35/15 ZN PERF 2000MM - DIN rail perforated

1206599

<https://www.phoenixcontact.com/us/products/1206599>



DIN rail perforated, similar to EN 60715, material: Steel, galvanized, Standard profile, color: silver, Pack of 25 (50 m)

RIF-1-RSC-LV-230AC/2X21 - Relay Module



2903347

<https://www.phoenixcontact.com/us/products/2903347>

NS 35/15 ZN UNPERF 2000MM - DIN rail, unperforated

1206586

<https://www.phoenixcontact.com/us/products/1206586>



DIN rail, unperforated, similar to EN 60715, material: Steel, galvanized, Standard profile, color: silver, Pack of 25 (50 m)

NS 35/15 CU UNPERF 2000MM-VPE 10 - DIN rail, unperforated

1201895

<https://www.phoenixcontact.com/us/products/1201895>



DIN rail, unperforated, similar to EN 60715, material: Copper, uncoated, Standard profile, color: copper-colored, Pack of 10 (20 m)

RIF-1-RSC-LV-230AC/2X21 - Relay Module



2903347

<https://www.phoenixcontact.com/us/products/2903347>

NS 35/15 CAP - End cap

1206573

<https://www.phoenixcontact.com/us/products/1206573>

DIN rail end piece, for DIN rail NS 35/15



NS 35/15-2,3 UNPERF 2000MM-VPE 10 - DIN rail, unperforated

1201798

<https://www.phoenixcontact.com/us/products/1201798>

DIN rail, unperforated, acc. to EN 60715, material: Steel, galvanized, passivated with a thick layer, Standard profile 2.3 mm, color: silver, Pack of 10 (20 m)



RIF-1-RSC-LV-230AC/2X21 - Relay Module



2903347

<https://www.phoenixcontact.com/us/products/2903347>

MPS-MT - Test plugs

0201744

<https://www.phoenixcontact.com/us/products/0201744>



Test plugs, with solder connection up to 1 mm² conductor cross section, number of positions: 1, color: gray

MPS-IH WH - Insulating sleeve

0201663

<https://www.phoenixcontact.com/us/products/0201663>

Insulating sleeve, color: white



RIF-1-RSC-LV-230AC/2X21 - Relay Module



2903347

<https://www.phoenixcontact.com/us/products/2903347>

MPS-IH RD - Insulating sleeve

0201676

<https://www.phoenixcontact.com/us/products/0201676>

Insulating sleeve, color: red



MPS-IH BU - Insulating sleeve

0201689

<https://www.phoenixcontact.com/us/products/0201689>

Insulating sleeve, color: blue



RIF-1-RSC-LV-230AC/2X21 - Relay Module



2903347

<https://www.phoenixcontact.com/us/products/2903347>

MPS-IH YE - Insulating sleeve

0201692

<https://www.phoenixcontact.com/us/products/0201692>

Insulating sleeve, color: yellow



MPS-IH GN - Insulating sleeve

0201702

<https://www.phoenixcontact.com/us/products/0201702>

Insulating sleeve, color: green



RIF-1-RSC-LV-230AC/2X21 - Relay Module



2903347

<https://www.phoenixcontact.com/us/products/2903347>

MPS-IH GY - Insulating sleeve

0201728

<https://www.phoenixcontact.com/us/products/0201728>

Insulating sleeve, color: gray



MPS-IH BK - Insulating sleeve

0201731

<https://www.phoenixcontact.com/us/products/0201731>

Insulating sleeve, color: black



RIF-1-RSC-LV-230AC/2X21 - Relay Module



2903347

<https://www.phoenixcontact.com/us/products/2903347>

ZB 5 :UNBEDRUCKT - Zack marker strip

1050004

<https://www.phoenixcontact.com/us/products/1050004>



Zack marker strip, Strip, white, unlabeled, can be labeled with: PLOTMARK, CMS-P1-PLOTTER, mounting type: snapped, for terminal block width: 5.2 mm, lettering field size: 5.1 x 10.5 mm, Number of individual labels: 10

ZB 5 CUS - Zack marker strip

0824962

<https://www.phoenixcontact.com/us/products/0824962>



Zack marker strip, can be ordered: Strip, white, labeled according to customer specifications, mounting type: snap into tall marker groove, for terminal block width: 5.2 mm, lettering field size: 5.15 x 10.5 mm, Number of individual labels: 10

RIF-1-RSC-LV-230AC/2X21 - Relay Module



2903347

<https://www.phoenixcontact.com/us/products/2903347>

ZB 5,LGS:FORTL.ZAHLEN - Zack marker strip

1050017

<https://www.phoenixcontact.com/us/products/1050017>



Zack marker strip, Strip, white, labeled, printed horizontally: consecutive numbers 1 ... 10, 11 ... 20, etc. up to 491 ... 500, mounting type: snapped, for terminal block width: 5.2 mm, lettering field size: 5.15 x 10.5 mm, Number of individual labels: 10

ZB 5,QR:FORTL.ZAHLEN - Zack marker strip

1050020

<https://www.phoenixcontact.com/us/products/1050020>



Zack marker strip, white, Printed vertically: consecutive numbers 1 ... 10, 11 ... 20, etc. up to 491 ... 500, mounting type: snapped, for terminal block width: 5.2 mm, lettering field size: 5.15 x 10.5 mm

RIF-1-RSC-LV-230AC/2X21 - Relay Module

2903347

<https://www.phoenixcontact.com/us/products/2903347>

ZB 5,LGS:GLEICHE ZAHLEN - Zack marker strip

1050033

<https://www.phoenixcontact.com/us/products/1050033>



Zack marker strip, Strip, white, labeled, can be labeled with: CMS-P1-PLOTTER, printed horizontally: Identical numbers 1 or 2, etc. up to 100, mounting type: snapped, for terminal block width: 5.2 mm, lettering field size: 5.15 x 10.5 mm, Number of individual labels: 10

ZB 5,LGS:L1-N,PE - Zack marker strip

1050415

<https://www.phoenixcontact.com/us/products/1050415>



Zack marker strip, Strip, white, labeled, horizontal: L1, L2, L3, N, PE, L1, L2, L3, N, PE, mounting type: snapped, for terminal block width: 5.2 mm, lettering field size: 5.15 x 10.5 mm, Number of individual labels: 10

RIF-1-RSC-LV-230AC/2X21 - Relay Module



2903347

<https://www.phoenixcontact.com/us/products/2903347>

UC-TM 5 - Marker for terminal blocks

0818108

<https://www.phoenixcontact.com/us/products/0818108>



Marker for terminal blocks, Sheet, white, unlabeled, can be labeled with: BLUEMARK ID COLOR, BLUEMARK ID, BLUEMARK CLED, PLOTMARK, CMS-P1-PLOTTER, mounting type: snapped, for terminal block width: 5.2 mm, lettering field size: 4.6 x 10.5 mm, Number of individual labels: 96

UC-TM 5 CUS - Marker for terminal blocks

0824581

<https://www.phoenixcontact.com/us/products/0824581>



Marker for terminal blocks, can be ordered: by sheet, white, labeled according to customer specifications, mounting type: snap into tall marker groove, for terminal block width: 5.2 mm, lettering field size: 10.5 x 4.6 mm, Number of individual labels: 96

RIF-1-RSC-LV-230AC/2X21 - Relay Module



2903347

<https://www.phoenixcontact.com/us/products/2903347>

UCT-TM 5 - Marker for terminal blocks

0828734

<https://www.phoenixcontact.com/us/products/0828734>



Marker for terminal blocks, Sheet, white, unlabeled, can be labeled with: TOPMARK NEO, TOPMARK LASER, BLUEMARK ID COLOR, BLUEMARK ID, BLUEMARK CLED, THERMOMARK PRIME, THERMOMARK CARD 2.0, THERMOMARK CARD, mounting type: snapped, for terminal block width: 5.2 mm, lettering field size: 4.6 x 10.5 mm, Number of individual labels: 72

UCT-TM 5 CUS - Marker for terminal blocks

0829595

<https://www.phoenixcontact.com/us/products/0829595>



Marker for terminal blocks, can be ordered: by sheet, white, labeled according to customer specifications, mounting type: snap into tall marker groove, for terminal block width: 5.2 mm, lettering field size: 4.6 x 10.5 mm, Number of individual labels: 72

RIF-1-RSC-LV-230AC/2X21 - Relay Module



2903347

<https://www.phoenixcontact.com/us/products/2903347>

GBS 5-25X12 - Group marker label for terminal marking

0810588

<https://www.phoenixcontact.com/us/products/0810588>



Group marker label, snaps onto terminal center for screw, spring-cage and quick connection terminal blocks, labeled with a 25 x 12 mm label or manually with the B-STIFT, in the foot part with ZB 5

GBS 5-25X5 - Group marker label for terminal marking

0829126

<https://www.phoenixcontact.com/us/products/0829126>



Group marking label, can be snapped into terminal center for screw, spring-cage, push-in, and fast connection terminal blocks, can be labeled with a 24 x 4 mm label or manually using B-STIFT, in the foot part with ZB 5

RIF-1-RSC-LV-230AC/2X21 - Relay Module



2903347

<https://www.phoenixcontact.com/us/products/2903347>

STP 5-2-ZB - Marker carriers

3037643

<https://www.phoenixcontact.com/us/products/3037643>



Marker carriers, snaps into ST 2,5 spring-cage terminal blocks, can be marked with UC-TM 5, UC-TMF 5, UCT-TM 5, UCT-TMF 5, ZB 5, or ZBF 5, gray, unlabeled, mounting type: snapped

ZB 15:UNBEDRUCKT - Zack marker strip

0811972

<https://www.phoenixcontact.com/us/products/0811972>



Zack marker strip, Strip, white, unlabeled, can be labeled with: PLOTMARK, CMS-P1-PLOTTER, mounting type: snapped, for terminal block width: 15.2 mm, lettering field size: 10.5 x 15.1 mm, Number of individual labels: 5

RIF-1-RSC-LV-230AC/2X21 - Relay Module

2903347

<https://www.phoenixcontact.com/us/products/2903347>

ZB 15 CUS - Zack marker strip

0824945

<https://www.phoenixcontact.com/us/products/0824945>



Zack marker strip, can be ordered: Strip, white, labeled according to customer specifications, mounting type: snap into tall marker groove, for terminal block width: 15.2 mm, lettering field size: 10.5 x 15.1 mm, Number of individual labels: 5

ZB 15,LGS:L1-N,PE - Zack marker strip

0811998

<https://www.phoenixcontact.com/us/products/0811998>



Zack marker strip, Strip, white, labeled, printed horizontally: L1, L2, L3, N, PE, mounting type: snapped, for terminal block width: 15.2 mm, lettering field size: 10.5 x 15.1 mm, Number of individual labels: 5

RIF-1-RSC-LV-230AC/2X21 - Relay Module



2903347

<https://www.phoenixcontact.com/us/products/2903347>

UC-TM 16 - Marker for terminal blocks

0819217

<https://www.phoenixcontact.com/us/products/0819217>



Marker for terminal blocks, Sheet, white, unlabeled, can be labeled with: BLUEMARK ID COLOR, BLUEMARK ID, BLUEMARK CLED, PLOTMARK, CMS-P1-PLOTTER, mounting type: snapped, for terminal block width: 16 mm, lettering field size: 15.45 x 10.5 mm, Number of individual labels: 32

UC-TMF 16 - Marker for terminal blocks

0819262

<https://www.phoenixcontact.com/us/products/0819262>



Marker for terminal blocks, Sheet, white, unlabeled, can be labeled with: BLUEMARK ID COLOR, BLUEMARK ID, BLUEMARK CLED, PLOTMARK, CMS-P1-PLOTTER, mounting type: snapped, for terminal block width: 16 mm, lettering field size: 15.45 x 5.1 mm, Number of individual labels: 32

RIF-1-RSC-LV-230AC/2X21 - Relay Module



2903347

<https://www.phoenixcontact.com/us/products/2903347>

RIF-1-BSC/2X21 - Relay base

2900930

<https://www.phoenixcontact.com/us/products/2900930>



RIF-1... relay base, for miniature power relay with 1 or 2 changeover contacts or identical solid-state relays, screw connection, plug-in option for input/interference suppression modules, for mounting on NS 35/7,5

REL-MR-230AC/21-21 - Single relay

2961451

<https://www.phoenixcontact.com/us/products/2961451>



Plug-in miniature power relay, with power contact, 2 changeover contacts, input voltage 230 V AC

RIF-1-RSC-LV-230AC/2X21 - Relay Module



2903347

<https://www.phoenixcontact.com/us/products/2903347>

RIF-LV-120-230 AC/110 DC - Plug-in module

2900944

<https://www.phoenixcontact.com/us/products/2900944>



Plug-in module, for mounting on RIF-1, RIF-2, RIF-3, and RIF-4, with varistor and yellow LED, input voltage: 120 V AC... 230 V AC / 110 V DC $\pm 20\%$

RIF-RH-1 - Retaining bracket

2900953

<https://www.phoenixcontact.com/us/products/2900953>



Relay retaining bracket, with ejector function and holder for marking material, suitable for RIF-1 relay base, for 16 mm tall miniature power relay and solid-state relay

Phoenix Contact 2023 © - all rights reserved
<https://www.phoenixcontact.com>

Phoenix Contact USA
586 Fulling Mill Road
Middletown, PA 17057, United States
(+717) 944-1300
info@phoenixcon.com