

PROPRIETARY INFORMATION:
 PROPRIETARY OF GLOBTEK, INC. ANY REPRODUCTION, DISCLOSURE OR USE OF THIS DRAWING, IN WHOLE OR IN PART, IS HEREBY PROHIBITED EXCEPT AS SPECIFIED IN WRITING BY GLOBTEK, INC.

REVISION			
REV	DESCRIPTION	DATE	APPROVED
A	INITIAL RELEASE, RFS. 27115, SV	06/29/18	MK
B	ADD ACCESSORY INPUT PLUG ADAPTORS FOR VARIOUS COUNTRIES, RFS. 27590, DR	12/28/20	DR
C	ADD P/N 602-701(R) TO ADAPTORS FOR VARIOUS COUNTRIES, RFS. 27857, DR	08/13/21	DR
D	UPDATE TABLE FOR VARIOUS COUNTRIES, RFS. 27680, DR	10/28/21	DR

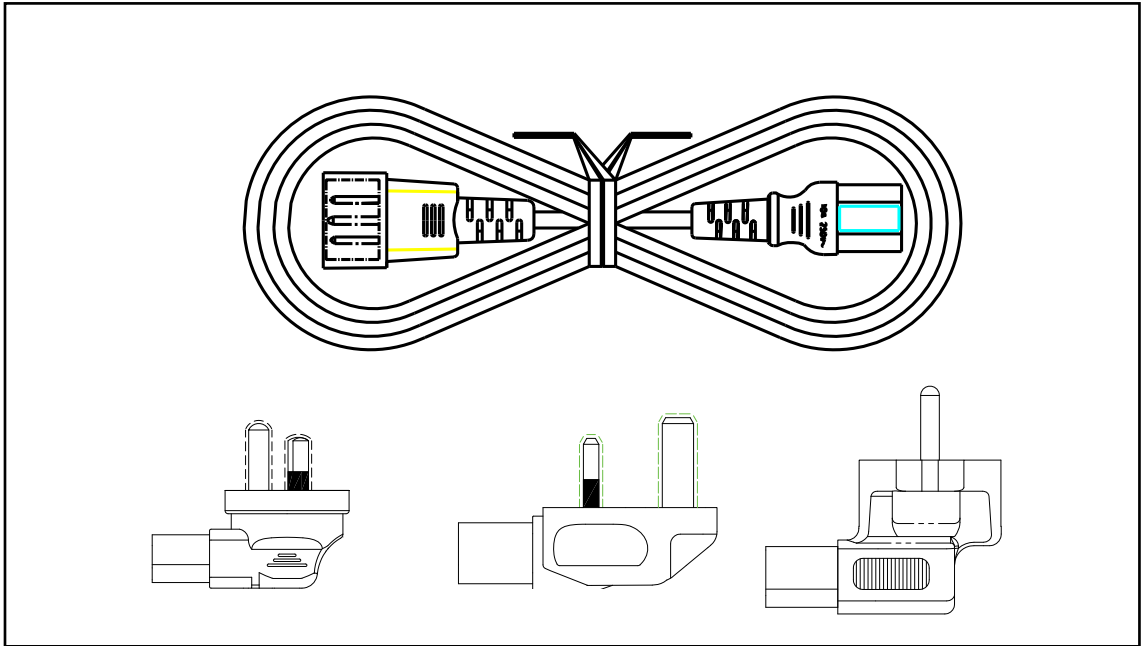

705-701-KIT-RA-INT-R INCLUDING:

1. 1 PC CORDSET P/N: 7055002M0701(R)
2. 1 PC ADAPTOR: 701-2314R(R)
3. 1 PC ADAPTOR: 701-550R(R)
4. 1 PC ADAPTOR: 701-610R(R)
5. 1 PC ZIP POLY BAG

DASH NO.	PART NO	REV.	DESCRIPTION	NOTES
TABULATION BLOCK				
		TOLERANCES: DECIMALS ANGULAR .xx +/- 0.1 +/- 1° .xxx +/- .005		GlobTek, Inc. www.globtek.com 186 Veterans Dr. Northvale, NJ 07647 Tel. 201-784-1000 Fax 201.784.0111
		MILLIMETERS ANGULAR .xx +/- 0.3 +/- 1° .xxx +/- .013		
INIT.BY: SV DATE: 06/29/18		DWG TITLE: INTERNATIONAL JUMPER CORDSET P/N: 7055002M0701(R) WITH 3 PC SET ADATOR: 701-2314R(R), 701-610R(R), 701-550R(R)		
DRAWN: NF DATE: 06/29/18		FSCN No.: G, CC	SIZE: A	REV. D
APRVD: MK DATE: 06/29/18		SCALE: NONE		PART NO: 705-701-KIT-RA-INT-R SHEET 1/6

Foot Note:
 Globtek Inc. will not be liable for the safety and performance of these power products if unauthorized access and repair occurs. End user should consult the applicable UL, CSA or EN Standards for proper installation instruction.

Limitation of Use:
 Globtek product are not authorized for use as mission critical components in life support, hazardous environment, nuclear or aircraft applications without prior written approval from the CEO of Globtek Inc.

Contents of this document are subject to change without prior notice

PROPRIETARY INFORMATION:

PROPRIETARY OF GLOBTEK, INC. ANY REPRODUCTION, DISCLOSURE OR USE OF THIS DRAWING, IN WHOLE OR IN PART, IS HEREBY PROHIBITED EXCEPT AS SPECIFIED IN WRITING BY GLOBTEK, INC.

CORDSET P/N: 7055002M0701(R)

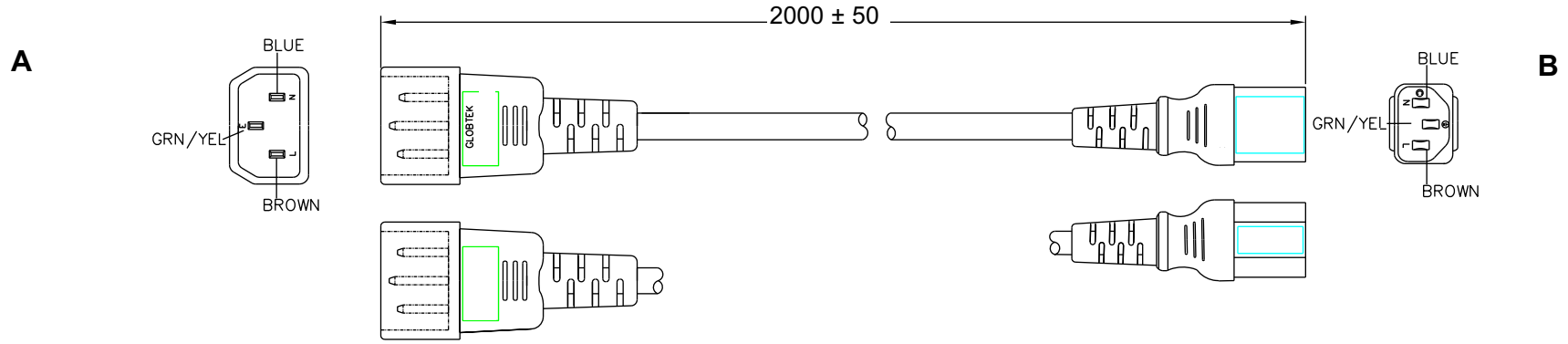

GENERAL SPECIFICATIONS:

- RATING: 10A / 250V AC
- CABLE TYPE / SIZE: SJT AWG 18X3 / H05VV-F 3X1.0 mm²
- TEMPERATURE RATING: 60° C
- CONDUCTOR COLORS: BLUE / BROWN / GREEN-YELLOW
- CABLE JACKET COLOR: BLACK
- OVERALL LENGTH (L): 2000 ± 50 mm
- CABLE OUTER DIAMETER: 8.3 ± 0.2 mm
- END 'A' PLUG; IEC 320 / C14
- END 'B' IEC 320 / C13
- APPROVALS PLUG: UL, CSA or cUL, VDE, N, S, D, FI, KEMA, SAA, UTE, CEBEC, OVE, IMQ, SEV
- APPROVALS CABLE: UL, CSA or cUL, VDE, N, S, D, FI, KEMA, SAA, SEV, CEBEC, OVE, IMQ
- APPROVALS CONNECTOR: UL, CSA or cUL, VDE, N, S, D, FI, BSI, KEMA, SEV, SAA, IMQ, UTE, CEBEC, OVE

PACKING:

HANKED

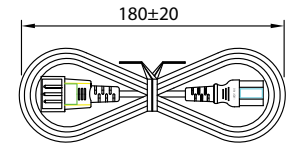

NOTES:

1. CORD, PLUG AND CONNECTOR MUST BE MARKED WITH APPROVAL SYMBOLS OR FILE NUMBER(S).



2. CABLE IS 3C/18 AWG/SJT AND 3C/1mm²/H05VV-F DUAL APPROVED FOR US AND EUROPE.

GlobTek, Inc.
www.globtek.com

186 Veterans Dr. Northvale, NJ 07647
Tel. 201-784-1000 Fax 201.784.0111

DWG TITLE: INTERNATIONAL JUMPER CORDSET P/N: 7055002M0701(R) WITH 3 PC SET ADATOR:
701-2314R(R), 701-610R(R), 701-550R(R)

PART NO: 705-701-KIT-RA-INT-R

REV.
D

SHEET 2/6

PROPRIETARY INFORMATION:

PROPRIETARY OF GLOBTEK, INC. ANY REPRODUCTION, DISCLOSURE OR USE OF THIS DRAWING, IN WHOLE OR IN PART, IS HEREBY PROHIBITED EXCEPT AS SPECIFIED IN WRITING BY GLOBTEK, INC.

Adaptor AUSTRALIAN 3 BLADES to IEC 320 C13: 701-550R(R)

Note:

1. Rating: 10A 250V
2. Insulation Resistance: 100MΩ
3. Dielectric Voltage: 2000V/sec

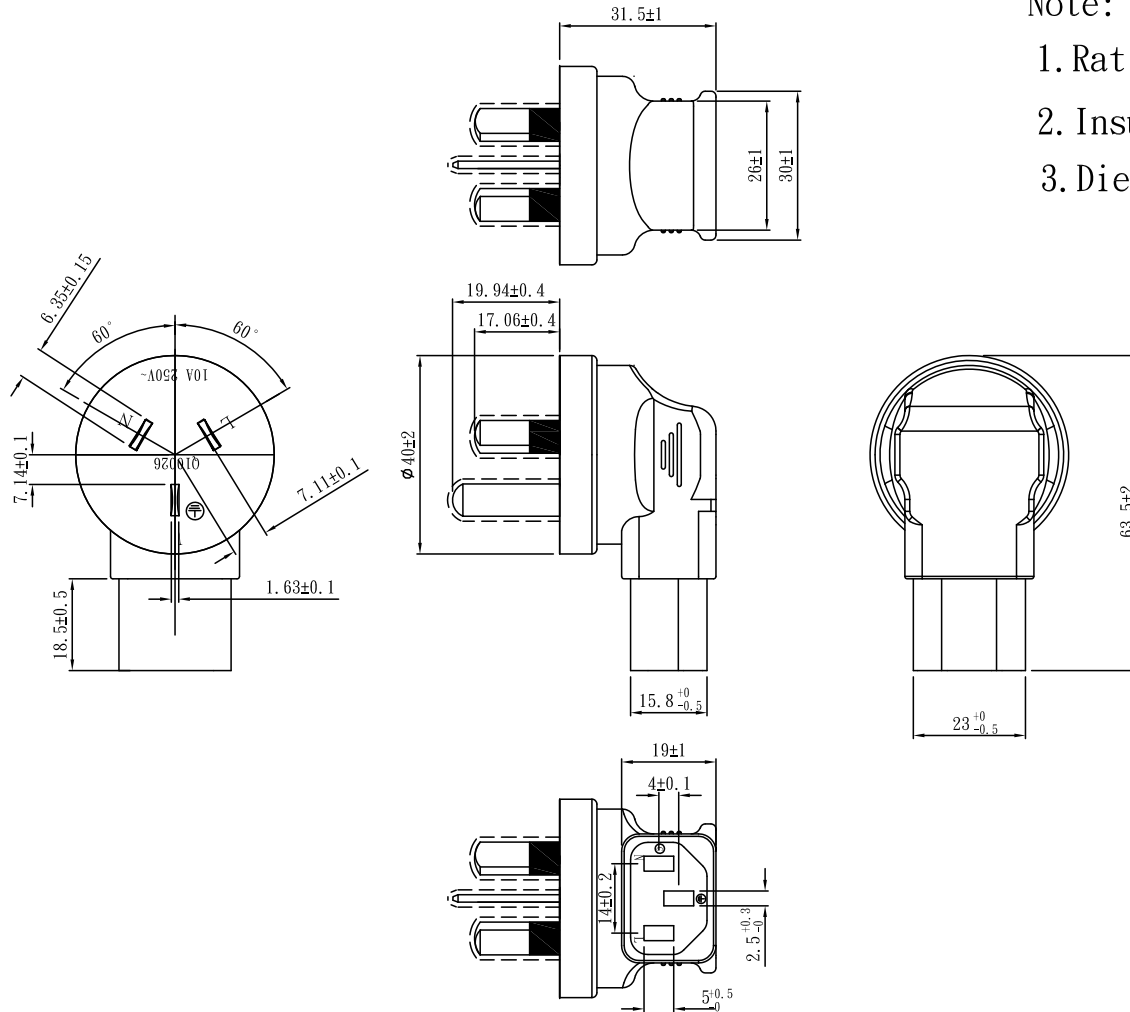

GlobTek, Inc.
www.globtek.com

186 Veterans Dr. Northvale, NJ 07647
Tel. 201-784-1000 Fax 201.784.0111

DWG TITLE: INTERNATIONAL JUMPER CORDSET P/N: 7055002M0701(R) WITH 3 PC SET ADATOR:
701-2314R(R), 701-610R(R), 701-550R(R)

PART NO: 705-701-KIT-RA-INT-R

REV.
D

SHEET 3/6

PROPRIETARY INFORMATION:
 PROPRIETARY OF GLOBTEK, INC. ANY REPRODUCTION, DISCLOSURE OR
 USE OF THIS DRAWING, IN WHOLE OR IN PART, IS HEREBY
 PROHIBITED EXCEPT AS SPECIFIED IN WRITING BY GLOBTEK, INC.

Adaptor UK PLUG to IEC 320 C13: 701-610R(R)

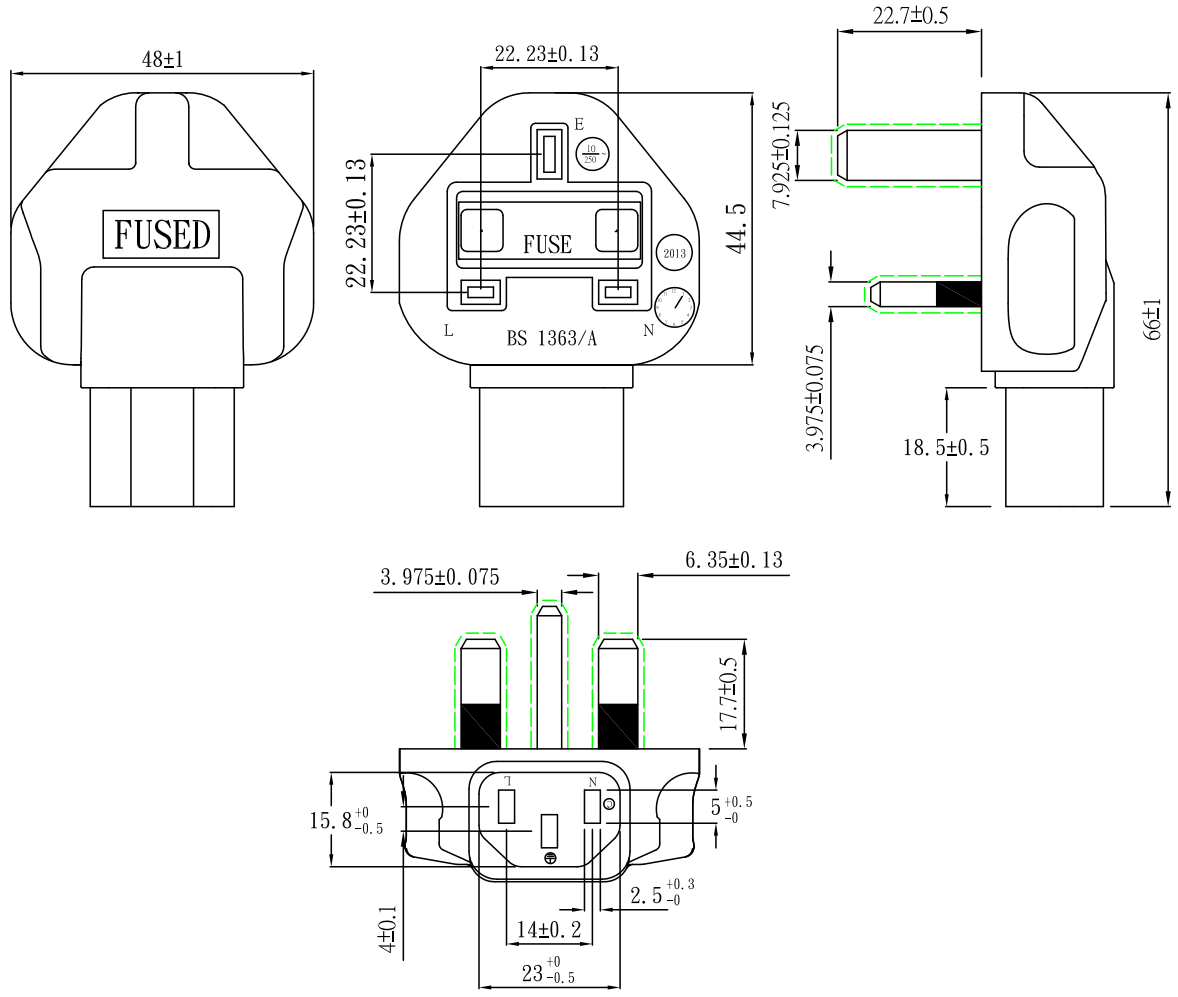

Note:

1. Rating: 10A 250V
2. Insulation Resistance: 100MΩ
3. Dielectric Voltage: 2000V/sec

GlobTek, Inc.
 www.globtek.com

186 Veterans Dr. Northvale, NJ 07647
 Tel. 201-784-1000 Fax 201.784.0111

DWG TITLE: INTERNATIONAL JUMPER CORDSET P/N: 7055002M0701(R) WITH 3 PC SET ADATOR:
 701-2314R(R), 701-610R(R), 701-550R(R)

REV.
 D

PART NO: 705-701-KIT-RA-INT-R SHEET 4/6

PROPRIETARY INFORMATION:
 PROPRIETARY OF GLOBTEK, INC. ANY REPRODUCTION, DISCLOSURE OR
 USE OF THIS DRAWING, IN WHOLE OR IN PART, IS HEREBY
 PROHIBITED EXCEPT AS SPECIFIED IN WRITING BY GLOBTEK, INC.

Adaptor EUROPEAN SCHUKO to IEC 320 C13: 701-2314R(R)

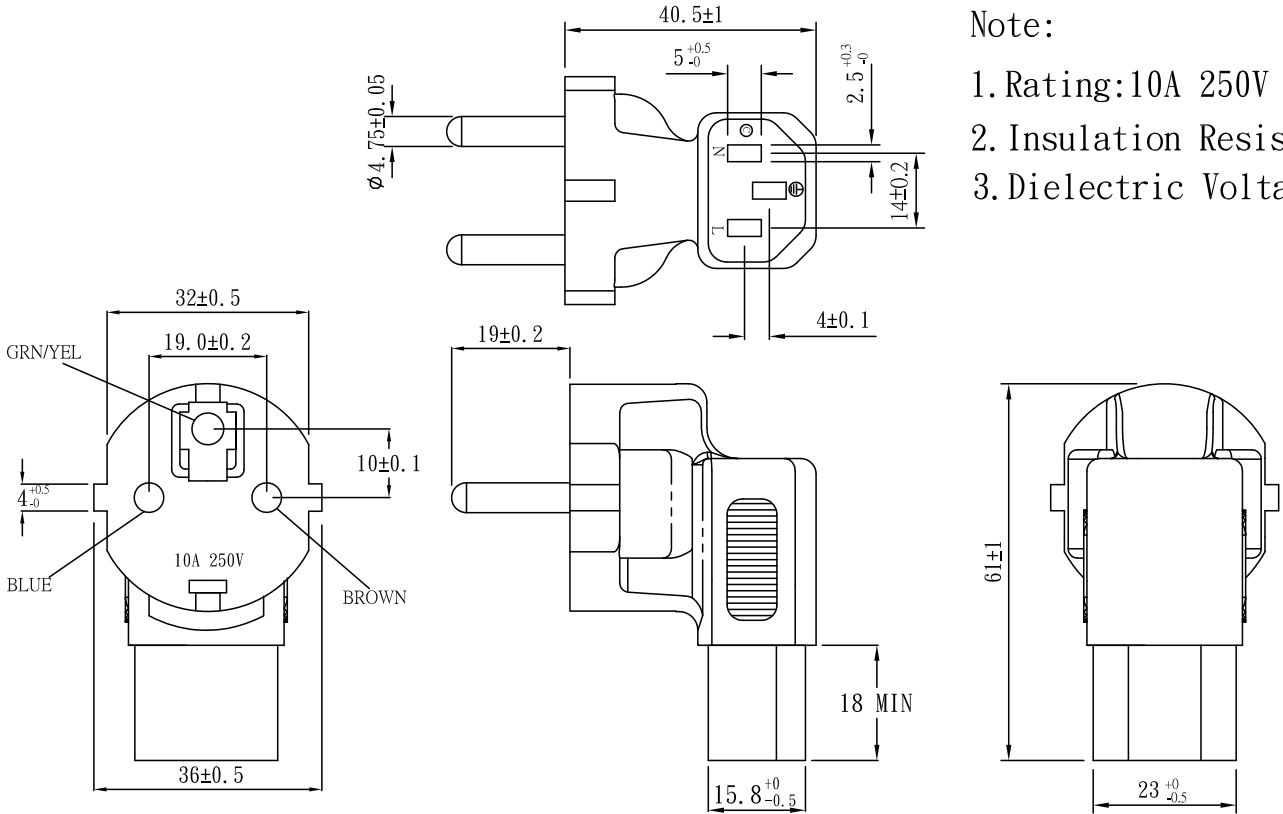

Note:

- 1. Rating: 10A 250V
- 2. Insulation Resistance: 100MΩ
- 3. Dielectric Voltage: 2000V/sec

 GlobTek, Inc. www.globtek.com		186 Veterans Dr. Northvale, NJ 07647 Tel. 201-784-1000 Fax 201.784.0111	
DWG TITLE: INTERNATIONAL JUMPER CORDSET P/N: 7055002M0701(R) WITH 3 PC SET ADATOR: 701-2314R(R), 701-610R(R), 701-550R(R)			
			REV. D
PART NO: 705-701-KIT-RA-INT-R			SHEET 5/6

PROPRIETARY INFORMATION:

PROPRIETARY OF GLOBTEK, INC. ANY REPRODUCTION, DISCLOSURE OR USE OF THIS DRAWING, IN WHOLE OR IN PART, IS HEREBY PROHIBITED EXCEPT AS SPECIFIED IN WRITING BY GLOBTEK, INC.

Accessory input plug adapters for various countries:

Accessory input plug adapters for various countries:		
Part #	Description	Included in this item
302-701(R)	NORTH AMER. PLUG ADAPTER, N5-15P (Type B) TO IEC60320/C13	X
302R-701R(R)	NORTH AMERICAN PLUG ADAPTER, ANGLED, NEMA 5-15P (TYPE B) TO IEC60320 C13	Order Separately
2314-701(R)	EURO PLUG ADAPTER CEE7/7 (Type E) TO IEC60320/C13	X
2314R-701R(R)	EUROPEAN PLUG ADAPTER, ANGLED, CEE 7/7 (TYPE F) TO IEC60320 C13	Order Separately
550-701(R)	AUSTRALIA PLUG ADAPTER AS/NZ 3112 (Type I) TO IEC60320/C13	X
550R-701(R)	AUSTRALIA PLUG, ANGLED, ADAPTER AS/NZ 3112 (Type I) TO IEC60320/C13	Order Separately
2302-701(R)	Plug Adapter, CEI 23-16 (Italy)(TYPE L) Plug to IEC 60320 C13 Connector	Order Separately
2321-701(R)	Plug Adapter, Switzerland SEV1011 (TYPE J) Plug to IEC60320 C13 Connector	Order Separately
610-701(R)	UK PLUG ADAPTER BS1363 (Type G) TO IEC60320/C13	X
610R-701(R)	UK PLUG ADAPTER. Angled, BS1363 (Type G) TO IEC60320/C13	Order Separately
208IN-701(R)	India Type M IS 1293:2005 Three Prong India BIS Plug 10A Max to IEC 60320 C13 Plug	Order Separately
C13C17-SLEEVE-BLKR(R)	INSERT SLEEVE, SPACER, FOR IEC 60320 C13 OR C17, BLACK, TO CREATE A TIGHT FIT	Order Separately
602-701(R)	China Plug Adapter, Output 3 Prongs China (Type I). Type GR2099, input IEC60320/C13	Order Separately



186 Veterans Dr. Northvale, NJ 07647
Tel. 201-784-1000 Fax 201.784.0111

DWG TITLE: INTERNATIONAL JUMPER CORDSET P/N: 7055002M0701(R) WITH 3 PC SET ADATOR:
701-2314R(R), 701-610R(R), 701-550R(R)

REV.
D

PART NO: **705-701-KIT-RA-INT-R**

SHEET 6/6