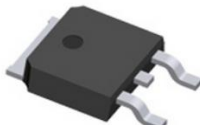
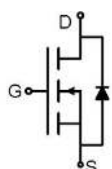

**60V N-Channel Enhancement Mode Power MOSFET**

# UMW 40N06

<p><b>General Description</b></p> <p>The 40N06 uses advanced trench technology and design to provide excellent <math>R_{DS(ON)}</math> with low gate charge. It can be used in a wide variety of applications.</p> <p><b>Features</b></p> <ul style="list-style-type: none"> <li>● <math>V_{DS} = 60V, I_D = 40A</math></li> <li>● <math>R_{DS(ON)}, 14m\Omega</math> (Typ) @ <math>V_{GS} = 10V</math></li> <li>● <math>R_{DS(ON)}, 16m\Omega</math> (Typ) @ <math>V_{GS} = 4.5V</math></li> <li>● Advanced Trench Technology</li> <li>● Excellent <math>R_{DS(ON)}</math> and Low Gate Charge</li> <li>● Lead free product is acquired</li> </ul> <p><b>Application</b></p> <ul style="list-style-type: none"> <li>● Load Switch</li> <li>● PWM Application</li> <li>● Power management</li> </ul>	 <p><b>TO-252(DPAK) top view</b></p>  <p><b>Schematic Diagram</b></p>
--	--

**Package Marking and Ordering Information**

Device Marking	Device	Device Package	Reel Size	Tape width	Quantity
40N06	40N06	TO-252	330mm	12mm	2500

**Absolute Maximum Ratings(TA=25°C unless otherwise noted)**

Parameter	Symbol	Value	Unit	
Drain-Source Voltage	$V_{DS}$	60	V	
Gate-Source Voltage	$V_{GS}$	±20	V	
Drain Current-Continuous <sup>Note3</sup>	$I_D$	TC=25°C	50	A
		TC=100°C	33	A
Drain Current-Pulsed <sup>Note1</sup>	$I_{DM}$	200	A	
Avalanche Energy <sup>Note4</sup>	$E_{AS}$	64	mJ	
Maximum Power Dissipation	$P_D$	105	W	
Storage Temperature Range	$T_{STG}$	-55 to +150	°C	
Operating Junction Temperature Range	$T_J$	-55 to +150	°C	

**Thermal Resistance**

Parameter	Symbol	Min.	Typ.	Max	Unit
Thermal Resistance, Junction-to-Case	$R_{\theta JC}$	-	-	1.4	°C/W

**Electrical Characteristics(T<sub>J</sub>=25°C unless otherwise noted)**

OFF CHARACTERISTICS						
Parameter	Symbol	Conditions	Min.	Typ.	Max.	Unit
Drain-Source Breakdown Voltage	BV <sub>DSS</sub>	V <sub>GS</sub> =0V, I <sub>DS</sub> =250uA	60	-	-	V
Zero Gate Voltage Drain Current	I <sub>DSS</sub>	V <sub>DS</sub> =60V, V <sub>GS</sub> =0V	-	-	1.0	uA
Gate-Body Leakage	I <sub>GSS</sub>	V <sub>GS</sub> =±20V, V <sub>DS</sub> =0V	-	-	±100	nA

ON CHARACTERISTICS						
Parameter	Symbol	Conditions	Min.	Typ.	Max.	Unit
Gate Threshold Voltage	V <sub>GS(TH)</sub>	V <sub>DS</sub> =V <sub>GS</sub> , I <sub>DS</sub> =250uA	1.0	1.6	2.5	V
Drain-Source On-State Resistance	R <sub>DS(ON)</sub>	V <sub>GS</sub> =10V, I <sub>DS</sub> =30A	-	14	18	mΩ
		V <sub>GS</sub> =4.5V, I <sub>DS</sub> =20A	-	16	22	mΩ

DYNAMIC CHARACTERISTICS						
Parameter	Symbol	Conditions	Min.	Typ.	Max.	Unit
Input Capacitance	C <sub>ISS</sub>	V <sub>DS</sub> =25V, V <sub>GS</sub> = 0V, f=1MHz	-	2928	-	pF
Output Capacitance	C <sub>OSS</sub>		-	141	-	
Reverse Transfer Capacitance	C <sub>rss</sub>		-	120	-	

SWITCHING CHARACTERISTICS						
Parameter	Symbol	Conditions	Min.	Typ.	Max.	Unit
Turn-On Delay Time	T <sub>d(on)</sub>	V <sub>GS</sub> =10V, V <sub>DS</sub> =30V, R <sub>GEN</sub> =1.8Ω I <sub>D</sub> =25A	-	7.5	-	ns
Rise Time	t <sub>r</sub>		-	6.0	-	
Turn-Off Delay Time	T <sub>d(off)</sub>		-	28.4	-	
Fall Time	t <sub>f</sub>		-	5.5	-	
Total Gate Charge at 10V	Q <sub>g</sub>	V <sub>DS</sub> =30V, I <sub>DS</sub> =25A, V <sub>GS</sub> =10V	-	50	-	nC
Gate to Source Gate Charge	Q <sub>gs</sub>		-	6	-	
Gate to Drain"Miller"Charge	Q <sub>gd</sub>		-	15	-	

DRAIN-SOURCE DIODE CHARACTERISTICS AND MAXIMUM RATINGS						
Parameter	Symbol	Conditions	Min.	Typ.	Max.	Unit
Drain-Source Diode Forward Voltage	V <sub>SD</sub>	V <sub>GS</sub> =0V, I <sub>DS</sub> =30A	-	-	1.2	V
Reverse Recovery Time	t <sub>rr</sub>	T <sub>J</sub> =25°C, I <sub>F</sub> =25A di/dt=100A/us	-	29	-	nS
Reverse Recovery Charge	Q <sub>rr</sub>		-	42	-	nC

**Notes:**

- 1: Repetitive rating, pulse width limited by maximum junction temperature.
- 2: Surface mounted on FR4 Board, t<sub>s</sub>≤10sec.
- 3: Pulse width ≤ 300μs, duty cycle ≤ 2%.
- 4: EAS condition: L=0.5mH, VDD=10V, VG=10V, V<sub>GATE</sub>=20V, Start T<sub>J</sub>=25°C.

**Figure 1: Output Characteristics**

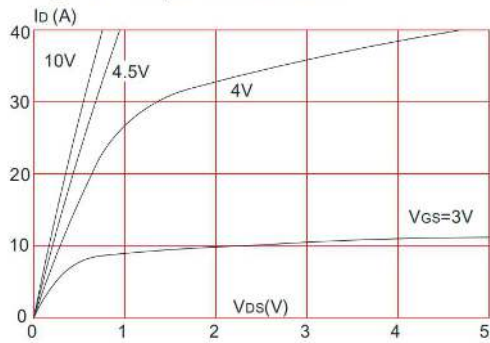

**Figure 2: Typical Transfer Characteristics**

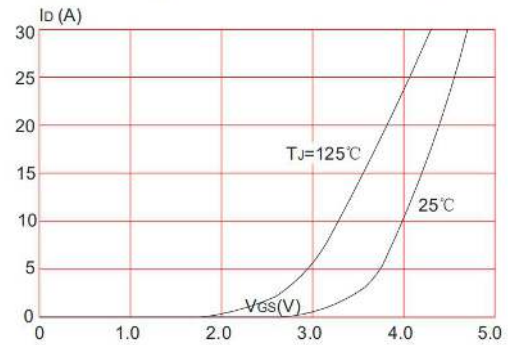

**Figure 3: On-resistance vs. Drain Current**

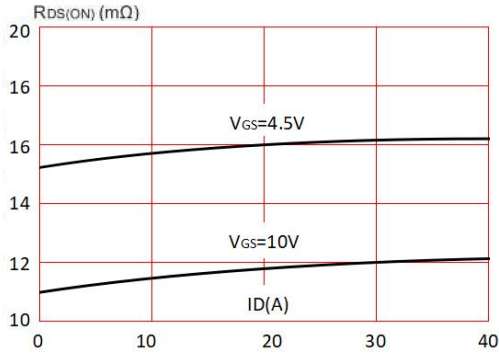

**Figure 4: Body Diode Characteristics**

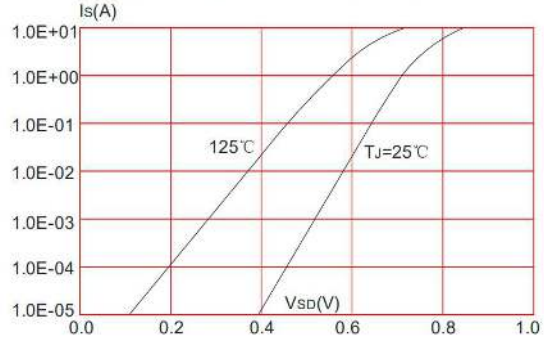

**Figure 5: Gate Charge Characteristics**

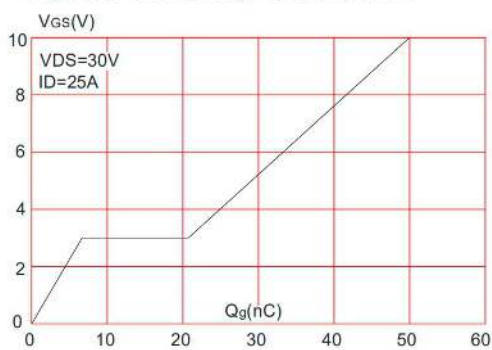

**Figure 6: Capacitance Characteristics**

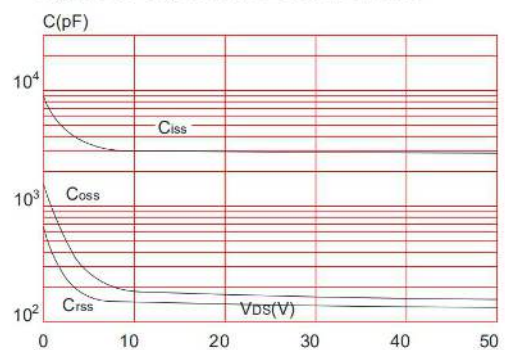

**Figure 7: Normalized Breakdown Voltage vs. Junction Temperature**

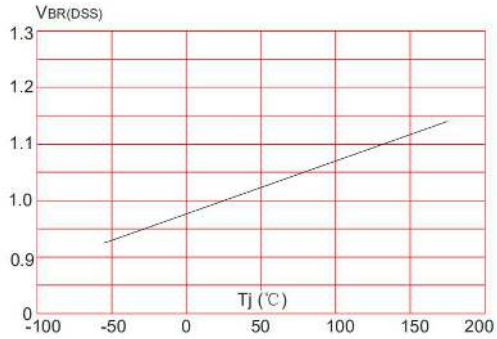

**Figure 8: Normalized on Resistance vs. Junction Temperature**

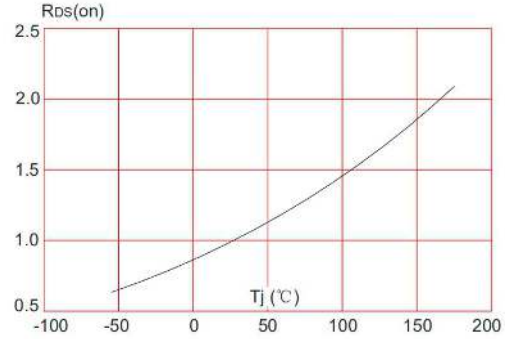

**Figure 9: Maximum Safe Operating Area**

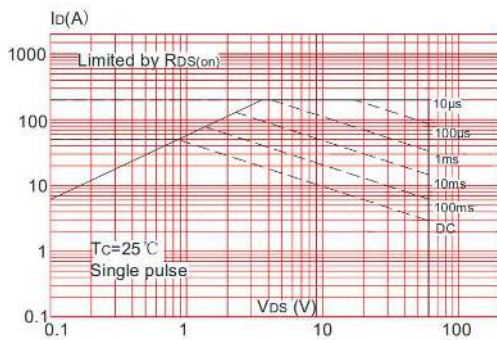

**Figure 10: Maximum Continuous Drain Current vs. Case Temperature**

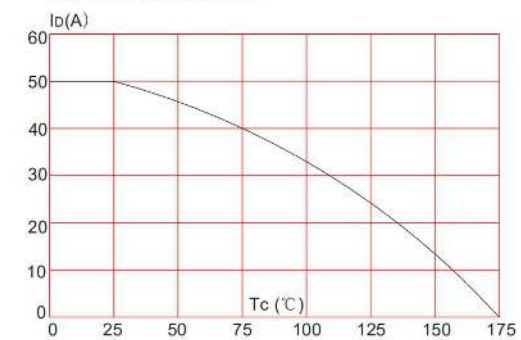

**Figure.11: Maximum Effective Transient Thermal Impedance, Junction-to-Case**

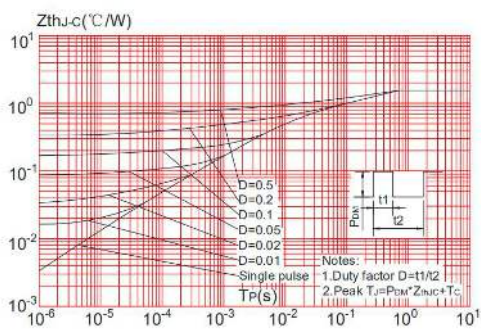

**Test Circuit**

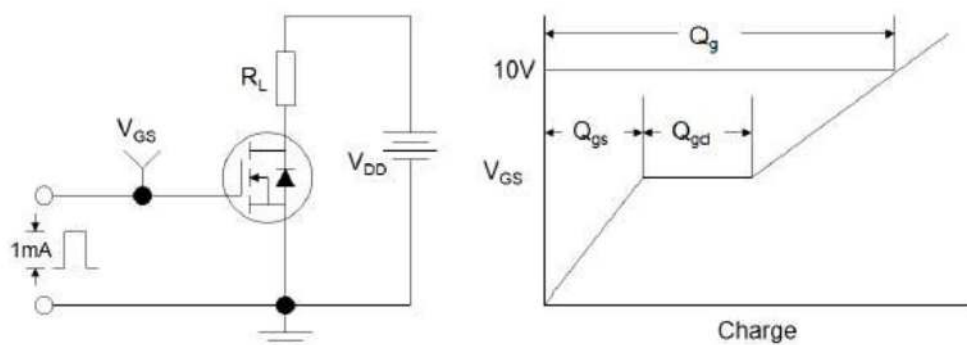

Figure1:Gate Charge Test Circuit & Waveform

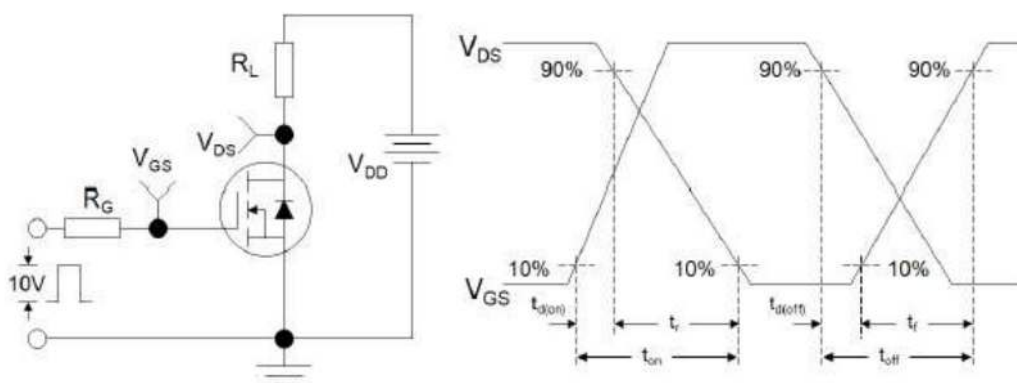

Figure 2: Resistive Switching Test Circuit & Waveforms

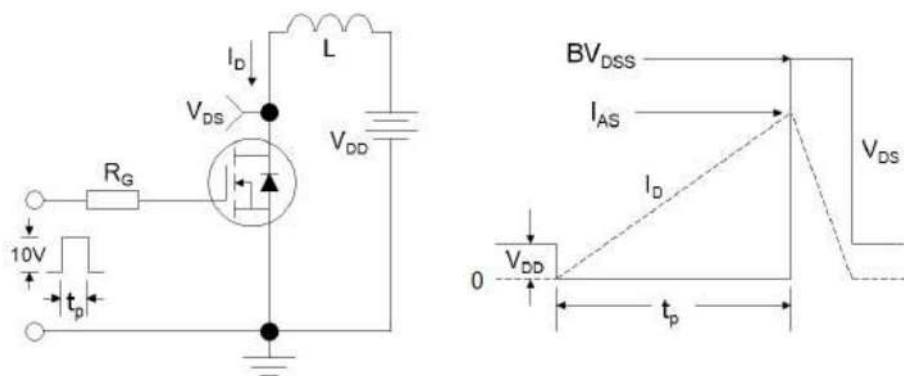
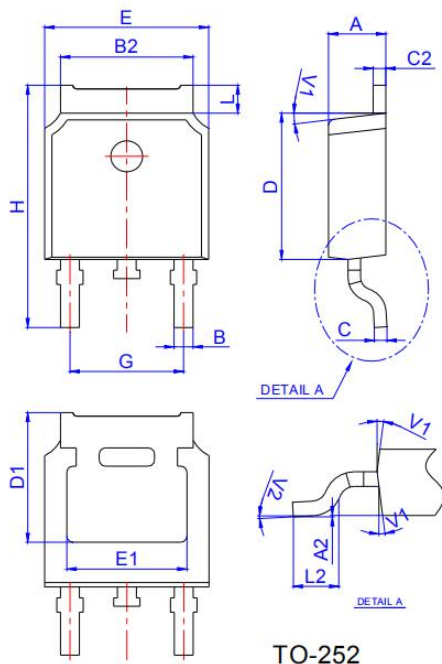

Figure 3:Unclamped Inductive Switching Test Circuit & Waveforms

**Package Mechanical Data**



Ref.	Dimensions					
	Millimeters			Inches		
	Min.	Typ.	Max.	Min.	Typ.	Max.
A	2.10		2.50	0.083		0.098
A2	0		0.10	0		0.004
B	0.66		0.86	0.026		0.034
B2	5.18		5.48	0.202		0.216
C	0.40		0.60	0.016		0.024
C2	0.44		0.58	0.017		0.023
D	5.90		6.30	0.232		0.248
D1	5.30REF			0.209REF		
E	6.40		6.80	0.252		0.268
E1	4.63			0.182		
G	4.47		4.67	0.176		0.184
H	9.50		10.70	0.374		0.421
L	1.09		1.21	0.043		0.048
L2	1.35		1.65	0.053		0.065
V1		7°			7°	
V2	0°		6°	0°		6°

**Reel Specification-TO-252**

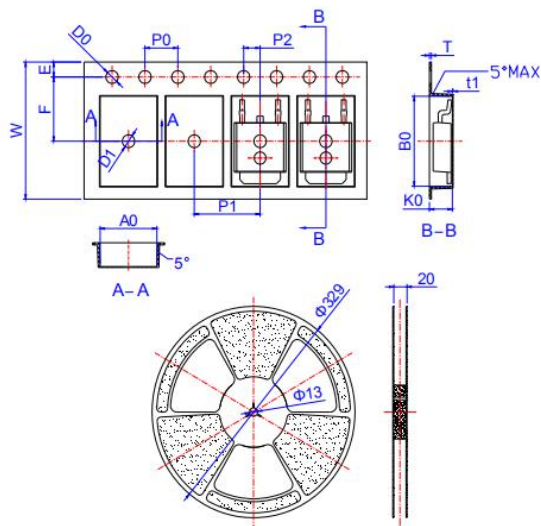

Ref.	Dimensions					
	Millimeters			Inches		
	Min.	Typ.	Max.	Min.	Typ.	Max.
W	15.90	16.00	16.10	0.626	0.630	0.634
E	1.65	1.75	1.85	0.065	0.069	0.073
F	7.40	7.50	7.60	0.291	0.295	0.299
D0	1.40	1.50	1.60	0.055	0.059	0.063
D1	1.40	1.50	1.60	0.055	0.059	0.063
P0	3.90	4.00	4.10	0.154	0.157	0.161
P1	7.90	8.00	8.10	0.311	0.315	0.319
P2	1.90	2.00	2.10	0.075	0.079	0.083
A0	6.85	6.90	7.00	0.270	0.271	0.276
B0	10.45	10.50	10.60	0.411	0.413	0.417
K0	2.68	2.78	2.88	0.105	0.109	0.113
T	0.24		0.27	0.009		0.011
t1	0.10			0.004		
10P0	39.80	40.00	40.20	1.567	1.575	1.583