

| REVISIONS | | | | | |
|-----------|-----|---------------------|-----------|--------|-------|
| REV | ECO | DESCRIPTION | DATE | BY | APPR |
| A1 | - | RELEASE NEW DRAWING | 05/APR/21 | SULLEN | TOMMY |

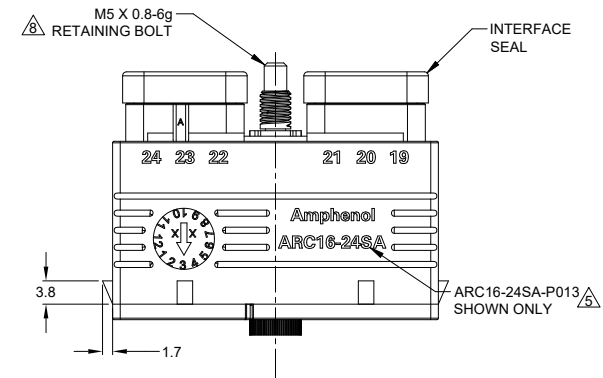
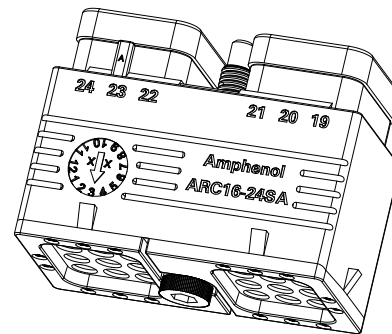
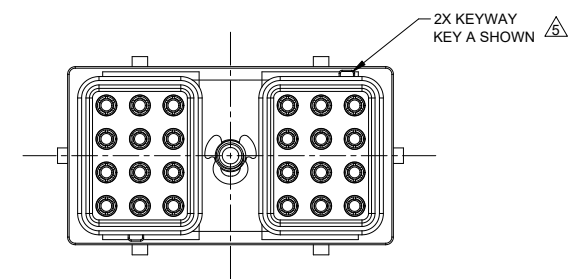
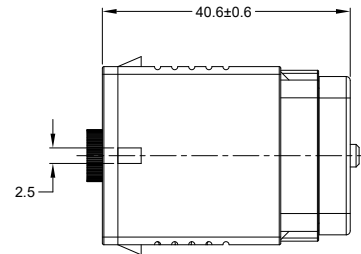
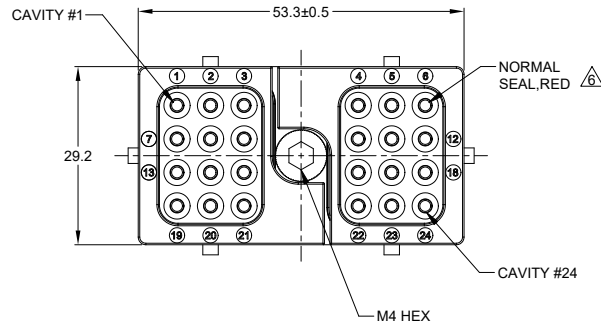

NOTES: UNLESS OTHERWISE SPECIFIED

- MATERIAL:
 - HOUSING: THERMOPLASTIC, BLACK
 - SEAL: SILICONE RUBBER
 - CLIP: STAINLESS STEEL
 - BOLD: STAINLESS STEEL
- MODIFICATIONS: NORMAL DIA. WIRE SEAL; INTERFACE SEALS ARE BONDED TO PLUG HOUSING
- SPECIFICATIONS:
 - 3.1 CURRENT RATING: 13 AMPS
 - 3.2 OPERATING TEMPERATURE: -55°C TO +125°C
 - 3.3 DIELECTRIC WITHSTANDING VOLTAGE: LESS THAN 2 MILLIAMPS CURRENT LEAKAGE @ 1500 VOLTS AC
 - 3.4 INSULATION RESISTANCE: 1000 MEGOHMS MIN @ 25°C
 - 3.5 MOISTURE RESISTANCE: IP68 (IM OF WATER FOR A PERIOD OF 24 HOURS, MATED CONDITION) IP69K (MATED CONDITION)
 - 3.6 MATING CYCLE DURABILITY: 100 CYCLES
 - 3.7 RoHS COMPLIANT
- MATING PART: ARC12-24PX* RECEPTACLE (* X = A,B,C,D KEYS ; * = ALL MODIFICATIONS)

SEE SHEET 2 FOR OTHER KEY ARRANGEMENTS

CONTACT SIZE AND REAR SEAL WIRE RANGE:

| CONTACT SIZE | MIN. INSUL O.D. | MAX. INSUL O.D. | TYPICAL WIRE RANGE |
|--------------|-------------------|-------------------|--|
| 16 | 2.54 mm (.100 in) | 3.40 mm (.134 in) | 14 - 20 AWG (2.0 - 0.5 mm ²) |

7. PLUG IS SUPPLIED WITH DUST CAP

8. MATING TORQUE REQUIREMENT: 25 - 28 IN-LB [2.82 - 3.16 Nm]

9. ALL DIMENSIONS ARE FOR REFERENCE USE ONLY

| SEE SHEET 2 | | DESCRIPTION | | ITEM |
|--------------------------------------|-------------|--|-----------|-----------------|
| QUANTITY | PART NUMBER | MATERIALS LIST | | |
| UNLESS OTHERWISE SPECIFIED | | SIGNATURES | | DATE |
| 1) All dimensions are in metric(mm). | | DRAWN: SULLEN,ZHANG | 05/APR/21 | |
| 2) Tolerances are as follows: | | CHECKED: ORION,LI | 06/APR/21 | |
| 1 PL DEC ±0.30 | | ENGINEER: | | |
| 2 PL DEC ±0.15 | | APPROVAL: TOMMY,XIE | 07/APR/21 | |
| 3 PL DEC ±0.08 | | CUSTOMER: | | |
| 3) Note reference = | | THIS DRAWING IS SUPPLIED FOR INFORMATION ONLY. DESIGN FEATURES, SPECIFICATIONS AND PERFORMANCE DATA SHOWN HEREON ARE THE PROPERTY OF THE AMPHENOL CORPORATION. NO RIGHTS OF REPRODUCTION ARE IMPLIED. ALL DIMENSIONS ARE SUBJECT TO NORMAL MANUFACTURING VARIATIONS. | | |
| MATERIAL SPECIFICATIONS: | | Sine Systems - www.amphenol-sine.com 44724 Morley Drive Clinton Township, MI 48036 | | |
| PROCESS SPECIFICATIONS: | | 24 POS, PLUG, SOCKET,ARC SERIES, KEYS, NORMAL SEAL,BLACK | | |
| NEXT ASSY: | | SIZE | TYPE | DWG NO. |
| | | B | C- | ARC16-24SX-P013 |
| | | SCALE: | NONE | REVISION |
| | | | | A1 |
| | | | | SHEET 1 OF 2 |

TITLE: 24 POS, PLUG, SOCKET,ARC SERIES,KEYED, NORMAL SEAL,BLACK
DWG NO: ARC16-24SX-P013
REV: A1
SH: 1
OF: 2

| REVISIONS | | | | | |
|-----------|-----|---------------------|-----------|--------|-------|
| REV | ECO | DESCRIPTION | DATE | BY | APPR |
| A1 | - | RELEASE NEW DRAWING | 05/APR/21 | SULLEN | TOMMY |

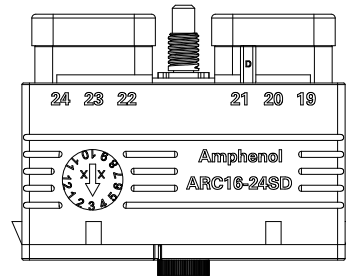
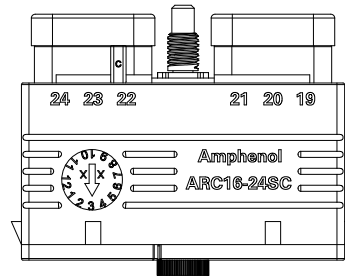
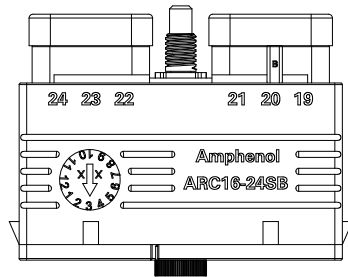
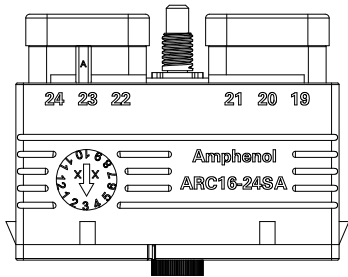
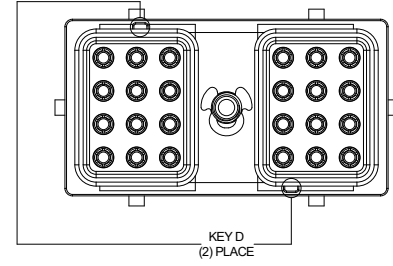
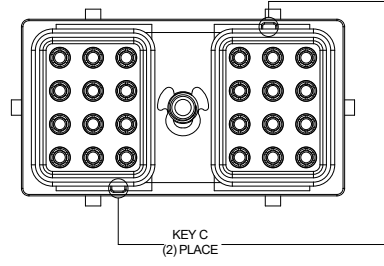
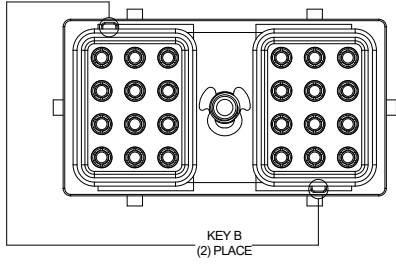
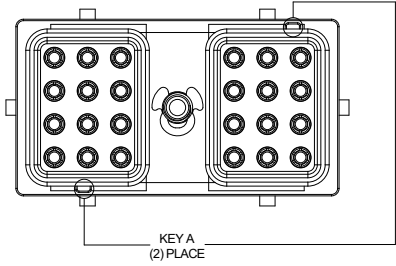

| ARC16-24SX-P013 VARIANTS | |
|--------------------------|-----------------|
| PART NUMBER | REF |
| ARC16-24SA-P013 | DRC16-24SA-P013 |

| ARC16-24SX-P013 VARIANTS | |
|--------------------------|-----------------|
| PART NUMBER | REF |
| ARC16-24SB-P013 | DRC16-24SB-P013 |

| ARC16-24SX-P013 VARIANTS | |
|--------------------------|-----------------|
| PART NUMBER | REF |
| ARC16-24SC-P013 | DRC16-24SC-P013 |



| ARC16-24SX-P013 VARIANTS | |
|--------------------------|-----------------|
| PART NUMBER | REF |
| ARC16-24SD-P013 | DRC16-24SD-P013 |



| ARC16-24SX-P013 | | DESCRIPTION | | ITEM |
|---|-------------|---|--|---|
| QUANTITY | PART NUMBER | | | |
| MATERIALS LIST | | | | |
| <small>UNLESS OTHERWISE SPECIFIED</small> 1) All dimensions are in metric(mm). 2) Tolerances are as follows: 1 PL DEC ±0.30 2 PL DEC ±0.15 3 PL DEC ±0.08 3) Note reference = | | <small>SIGNATURES</small> DRAWN: SULLEN,ZHANG 05/APR/21 CHECKED: ORIONLI 06/APR/21 ENGINEER: APPROVAL: TOMMY,XIE 07/APR/21 | | Amphenol Sine Systems - www.amphenol-sine.com 44724 Morley Drive Clinton Township, MI 48036 |
| <small>MATERIAL SPECIFICATIONS:</small> THIS DRAWING IS SUPPLIED FOR INFORMATION ONLY. DESIGN FEATURES, SPECIFICATIONS AND PERFORMANCE DATA SHOWN HEREON ARE THE PROPERTY OF THE AMPHENOL CORPORATION. NO RIGHTS OF REPRODUCTION ARE IMPLIED. ALL DIMENSIONS ARE SUBJECT TO NORMAL MANUFACTURING VARIATIONS. | | <small>CUSTOMER:</small> 24 POS, PLUG, SOCKET,ARC SERIES, KEYED, NORMAL SEAL,BLACK | | |
| <small>PROCESS SPECIFICATIONS:</small> | | <small>THIS DRAWING IS SUPPLIED FOR INFORMATION ONLY. DESIGN FEATURES, SPECIFICATIONS AND PERFORMANCE DATA SHOWN HEREON ARE THE PROPERTY OF THE AMPHENOL CORPORATION. NO RIGHTS OF REPRODUCTION ARE IMPLIED. ALL DIMENSIONS ARE SUBJECT TO NORMAL MANUFACTURING VARIATIONS.</small> | | <small>REVISION</small> A1 |
| <small>NEXT ASSY:</small> | | <small>SCALE:</small> NONE | | <small>SHEET</small> 2 <small>OF</small> 2 |





TITLE: 24 POS, PLUG, SOCKET,ARC SERIES,KEYED, NORMAL SEAL,BLACK
 DWG NO: ARC16-24SX-P013
 REV: A1
 SH: 2
 OF: 2

AT Series™ - Contact Size 16 Options



| Machined Contacts, Sockets & Pins | | | | |
|-----------------------------------|--|------|-------|----------|
| Part Number | Description | Size | AWG | Type |
| AT60-215-1631 | Male Contact - Pin, Gold-plated | 16 | 14 | Machined |
| AT62-209-1631 | Female Contact - Socket, Gold-plated | 16 | 14 | Machined |
| AT60-215-16141 | Male Contact - Pin, Nickel-plated | 16 | 14 | Machined |
| AT62-209-16141 | Female Contact - Socket, Nickel-plated | 16 | 14 | Machined |
| AT60-202-1631 | Male Contact - Pin, Gold-plated | 16 | 16-20 | Machined |
| AT62-201-1631 | Female Contact - Socket, Gold-plated | 16 | 16-20 | Machined |
| AT60-202-16141 | Male Contact - Pin, Nickel-plated | 16 | 16-20 | Machined |
| AT62-201-16141 | Female Contact - Socket, Nickel-plated | 16 | 16-20 | Machined |
| AT60-202-1631-22 | Male Contact - Pin, Gold-plated | 16 | 22-24 | Machined |
| AT62-201-1631-22 | Female Contact - Socket, Gold-plated | 16 | 22-24 | Machined |
| AT60-202-16141-22 | Male Contact - Pin, Nickel-plated | 16 | 22-24 | Machined |
| AT62-201-16141-22 | Female Contact - Socket, Nickel-plated | 16 | 22-24 | Machined |

| Tooling - Machined Contacts | | |
|---|-------------|---|
| Part | Part Number | Description |
|  | CA-5D12 | Universal Hand Crimp Tool, Size 12/16/20 (Machined contacts only) |
|  | CA-5E12 | Pneumatic Crimp Tool, Size 12/16/20 (Machined contacts only) |

| Contact Removal Tools | | |
|---|---------------|---|
| Part | Part Number | Description |
|  | ART-100 | Used for removal of contacts for A Series™ products |
|  | AT11-310-1605 | Contact Removal Tool, Plastic, Size 16 |

| Sealing Plugs | | |
|---|------------------|---|
| Part | Part Number | Description |
|  | A114017 | Sealing Plug, Size 16, White |
|  | A114017-SR | Sealing Plug, Size 16, SR01 Series, Black |
|  | AT13-217-1605 | Locking Sealing Plug, Size 16, Grey |
|  | AT13-217-1605-SR | Locking Sealing Plug, Size 16, SR01 Series, Red |

| Stamped & Formed Contacts, Sockets & Pins | | | | |
|---|--|------|-------|------------------|
| Part Number | Description | Size | AWG | Type |
| AT60-14-0144 | Male Contact - Pin, Gold-plated | 16 | 14-16 | Stamped & Formed |
| AT62-14-0144 | Female Contact - Socket, Gold-plated | 16 | 14-16 | Stamped & Formed |
| AT60-14-0122 | Male Contact - Pin, Nickel-plated | 16 | 14-16 | Stamped & Formed |
| AT62-14-0122 | Female Contact - Socket, Nickel-plated | 16 | 14-16 | Stamped & Formed |
| AT60-16-0144 | Male Contact - Pin, Gold-plated | 16 | 16-18 | Stamped & Formed |
| AT62-16-0144 | Female Contact - Socket, Gold-plated | 16 | 16-18 | Stamped & Formed |
| AT60-16-0122 | Male Contact - Pin, Nickel-plated | 16 | 16-18 | Stamped & Formed |
| AT62-16-0122 | Female Contact - Socket, Nickel-plated | 16 | 16-18 | Stamped & Formed |
| AT60-16-0644 | Male Contact - Pin, Gold-plated | 16 | 18-20 | Stamped & Formed |
| AT62-16-0644 | Female Contact - Socket, Gold-plated | 16 | 18-20 | Stamped & Formed |
| AT60-16-0622 | Male Contact - Pin, Nickel-plated | 16 | 18-20 | Stamped & Formed |
| AT62-16-0622 | Female Contact - Socket, Nickel-plated | 16 | 18-20 | Stamped & Formed |
| AT60-16-0844 | Male Contact - Pin, Gold-plated | 16 | 20-22 | Stamped & Formed |
| AT62-16-0844 | Female Contact - Socket, Gold-plated | 16 | 20-22 | Stamped & Formed |
| AT60-16-0822 | Male Contact - Pin, Nickel-plated | 16 | 20-22 | Stamped & Formed |
| AT62-16-0822 | Female Contact - Socket, Nickel-plated | 16 | 20-22 | Stamped & Formed |

| Tooling - Stamped & Formed Contacts | | |
|--|-------------|---|
| Part | Part Number | Description |
|  | MF-3950 | Crimp Die - Size 16, 18-20AWG (S&F contacts only) |
| | MF-3953 | Crimp Die - Size 16, 16-18AWG (S&F contacts only) |
| | MF-3975 | Crimp Die - Size 16, 14-16AWG (S&F contacts only) |
| | MF-3990 | Crimp Die - Size 16, 20-22AWG (S&F contacts only) |
|  | ATT-16-00 | Hand Crimp Tool - Size 16, 14-16AWG (S&F contacts only) |
| | ATT-16-01 | Hand Crimp Tool - Size 16, 18-20AWG (S&F contacts only) |
| | ATT-1612-03 | Hand Crimp Tool - Size 16, 20-22AWG (S&F contacts only) |

Amphenol Sine Systems
 44724 Morley Drive
 Clinton Township, MI 48036 USA
www.amphenol-sine.com
 03/2022