

SENSOR TEMPERATURE SENSING CRYSTAL

HTS-206

- Crystal used to sense the change in temperature.
- 2 mm in diameter and 6 mm in length.
- Good linearity frequency and temperature.
- Low frequency (32.4 kHz) enables low current consumption.
- Wide temperature range (-40 °C to +85 °C).
- Suitable for DTCXO and temperature equipment.



Product number (please contact us)
Q19HT2060xxxx00

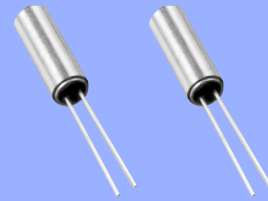

Actual size



Specifications (characteristics)

Item	Symbol	Specifications	Conditions / Remarks
Nominal frequency range	f_nom	32.4 kHz	
Temperature range	Storage temperature	T_stg	-55 °C to +125 °C
	Operating temperature	T_use	-40 °C to +85 °C
Level of drive	DL	0.1 μW Typ.	GL:1.0 μW Max.
Frequency tolerance	f_tol	±2 %	Ta=+25 °C ,DL=0.1 μW
1st.Temperature coefficient	α	-26.0 × 10 ⁻⁶ / °C (±2 %)	
2nd.Temperature coefficient	β	-5.8 × 10 ⁻⁸ / °C ² (±8 %)	
3rd.Temperature coefficient	γ	-1.5 × 10 ⁻¹⁰ / °C ³ Max.	
Motional resistance (ESR)	R1	35 kΩ Max.	Ta=+25 °C,DL=0.1 μW
Motional capacitance	C1	1.8 fF Typ.	
Shunt capacitance	C0	0.8 pF Typ.	
Frequency aging	f_age	± 3 × 10 ⁻⁶ / year Max.	Ta=+25 °C

Product Name HTS-206 32.40000kHz 11.0 +20000-20000
(Standard form) ① ② ③ ④

①Model ②Frequency ③Load capacitance(pF) ④Frequency tolerance(× 10⁻⁶,+25 °C) (②③④: Fixed.)

External dimensions

(Unit:mm)

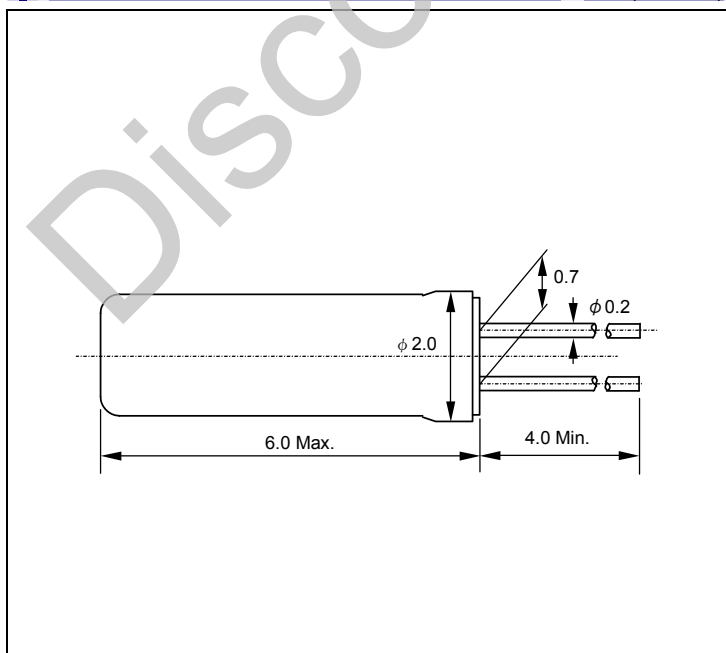

Frequency Temperature coefficient

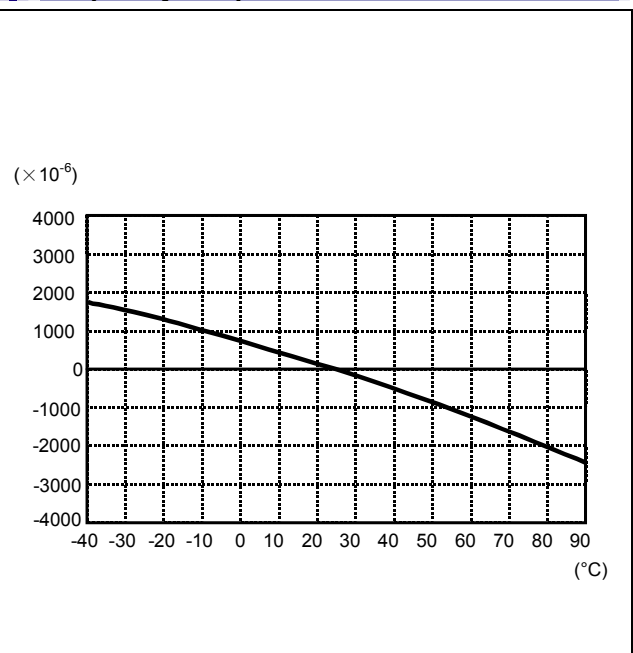

PROMOTION OF ENVIRONMENTAL MANAGEMENT SYSTEM CONFORMING TO INTERNATIONAL STANDARDS

At Seiko Epson, all environmental initiatives operate under the Plan-Do-Check-Action (PDCA) cycle designed to achieve continuous improvements. The environmental management system (EMS) operates under the ISO 14001 environmental management standard.

All of our major manufacturing and non-manufacturing sites, in Japan and overseas, completed the acquisition of ISO 14001 certification.

ISO 14000 is an international standard for environmental management that was established by the International Standards Organization in 1996 against the background of growing concern regarding global warming, destruction of the ozone layer, and global deforestation.





WORKING FOR HIGH QUALITY

In order provide high quality and reliable products and services than meet customer needs,

Seiko Epson made early efforts towards obtaining ISO9000 series certification and has acquired ISO9001 for all business establishments in Japan and abroad. We have also acquired ISO/TS 16949 certification that is requested strongly by major automotive manufacturers as standard.

ISO/TS 16949 is the international standard that added the sector-specific supplemental requirements for automotive industry based on ISO9001.

► Explanation of the mark that are using it for the catalog

	► Pb free.
	► Complies with EU RoHS directive. *About the products without the Pb-free mark. Contains Pb in products exempted by EU RoHS directive. (Contains Pb in sealing glass, high melting temperature type solder or other.)
	► Designed for automotive applications such as Car Multimedia, Body Electronics, Remote Keyless Entry etc.
	► Designed for automotive applications related to driving safety (Engine Control Unit, Air Bag, ESC etc.)

Notice

- This material is subject to change without notice.
- Any part of this material may not be reproduced or duplicated in any form or any means without the written permission of Seiko Epson.
- The information about applied circuitry, software, usage, etc. written in this material is intended for reference only. Seiko Epson does not assume any liability for the occurrence of infringing on any patent or copyright of a third party. This material does not authorize the licensing for any patent or intellectual copyrights.
- When exporting the products or technology described in this material, you should comply with the applicable export control laws and regulations and follow the procedures required by such laws and regulations.
- You are requested not to use the products (and any technical information furnished, if any) for the development and/or manufacture of weapon of mass destruction or for other military purposes. You are also requested that you would not make the products available to any third party who may use the products for such prohibited purposes.
- These products are intended for general use in electronic equipment. When using them in specific applications that require extremely high reliability, such as the applications stated below, you must obtain permission from Seiko Epson in advance.
/ Space equipment (artificial satellites, rockets, etc.) / Transportation vehicles and related (automobiles, aircraft, trains, vessels, etc.) / Medical instruments to sustain life / Submarine transmitters / Power stations and related / Fire work equipment and security equipment / traffic control equipment / and others requiring equivalent reliability.
- All brands or product names mentioned herein are trademarks and/or registered trademarks of their respective.