

Notes:
No. of Positions 64 with three key; Other positions with one key

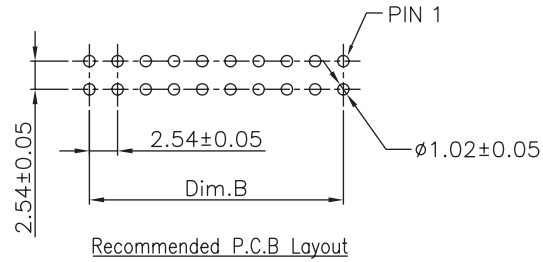

TECHNICAL CHARACTERISTICS

MATERIAL
INSULATOR: PBT
FLAMMABILITY RATING: UL94-V0
COLOR: BLACK
CONTACT MATERIAL: COPPER ALLOY
CONTACT TYPE: STAMPED
CONTACT PLATING: GOLD
QUALITY CLASS: 3 AS PER CECC 75 301-802
PITCH: 2.54 MM

ENVIRONMENTAL
OPERATING TEMPERATURE: -40 UP TO 125°C
COMPLIANCE: LEAD FREE AND ROHS

ELECTRICAL
CURRENT RATING: 3A MAX
WORKING VOLTAGE: 250 VAC
INSULATOR RESISTANCE: >1000 MOHM
DIELECTRIC WITHSTANDING VOLTAGE: 500 VAC/MN
CONTACT RESISTANCE: 20 mOHM MAX

STANDARD
CERTIFIED: E323964

SOLDERING
JEDEC LEAD FREE WAVE SOLDERING PROCESS

PACKAGING
TRAY

DIMENSION

No. of Positions	Dim A	Dim B	No. of Positions	Dim A	Dim B
10	32.00	10.16	40	70.10	48.26
14	37.08	15.24	50	82.85	60.96
16	39.62	17.78	60	95.50	73.66
20	44.70	22.86			
24	49.78	27.94			
26	52.30	30.48			
30	57.40	35.56			
34	62.50	40.64			

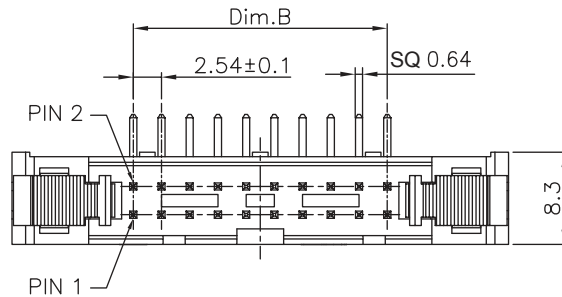
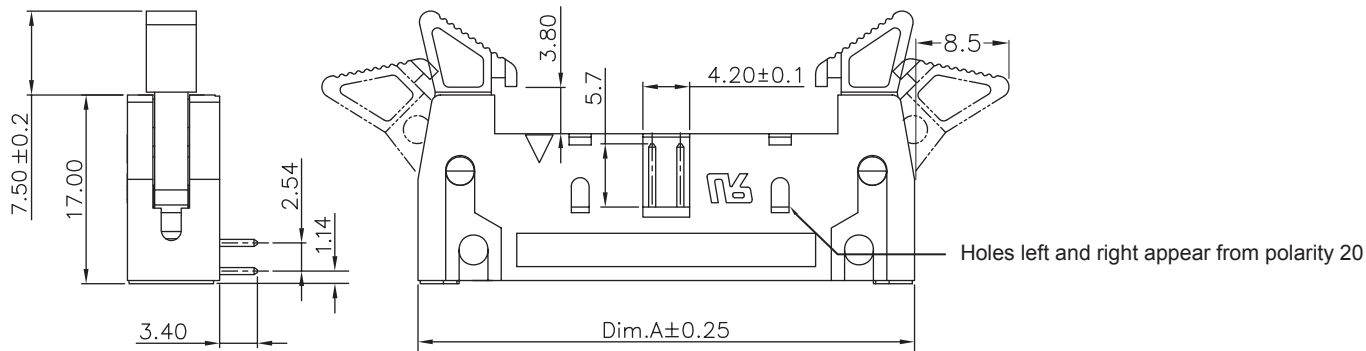

RoHS Compliant			
L	19-JAN-17	SILHOUETTE	AK
K	20-OCT-15	NOTES	AK
J	24-SEP-13	TABLE PINNING	QL
I	19-MAR-13	NOTES	AR
H	20-FEB-13	OVERALL LENGHT	QL
REV	DATE	FILE	BY

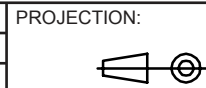

GENERAL TOLERANCE
.X = +/- 0.2
.XX = +/- 0.15



APPROVAL: GMo

UNIT: MM

DESCRIPTION: 2.54MM MALE ANGLED BOX HEADER WITH SHORT LEVER

SIZE

SCALE:

WERI PART NO: 612 0xx 221 21

A4

DRAW: MIKE

1

2

3

4

5

Note:

1.Dimension:

Tray Size:460(L)x260(W)x33(H) (mm)

Catron Size:470(L)x270(W)x350(H) (mm)

2.Quantity:

Circuits	Pcs/Tary	Tarys/Carton	Q'TY
06	210	11	2310
08	196	11	2156
10	182	11	2002
14	154	11	1694
16	140	11	1540
20	126	11	1386
24-26	112	11	1232
30	98	11	1078
34-40	84	11	924
50	70	11	770
60-64	56	11	616

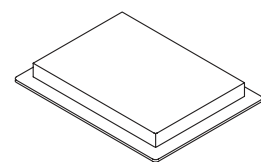

TRAY

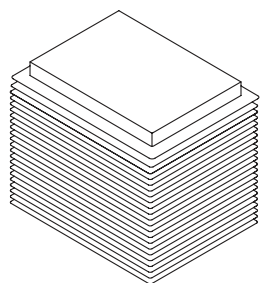

11 TRAYS

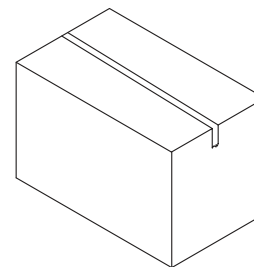
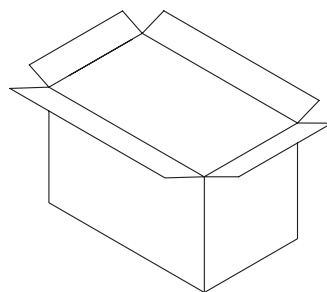

CARTON

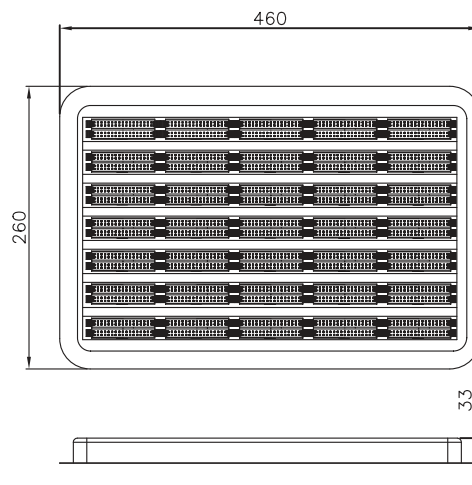

RoHS Compliant

PROJECTION:



GENERAL TOLERANCE

.X = +/- 0.2

.XX = +/- 0.15



APPROVAL: GMo

UNIT: MM

SCALE:

SHEET: 2/3

DRAW: PEARL

DESCRIPTION: 2.54MM MALE ANGLED BOX HEADER WITH SHORT LEVER

WERI PART NO: 612 0xx 221 21

SIZE

A4

REV	DATE	FILE	BY
G			
F			
E			
D			
C			
B			
A			

1

2

3

4

5

Cautions and Warnings:

This electronic component is designed and developed with the intention for use in general electronics equipments.



Before incorporating the components into any equipments in the field such as aerospace, aviation, nuclear control, submarine, transportation, (automotive control, train control, ship control), transportation signal, disaster prevention, medical, public information network etc. where higher safety and reliability are especially required or if there is possibility of direct damage or injury to human body, Würth Elektronik must be asked for a written approval.

In addition, even electronic component in general electronic equipments, when used in electrical circuits that require high safety, reliability functions or performance, the sufficient reliability evaluation-check for the safety must be performed before by the user before usage.

A

B

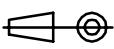
C

RoHS Compliant				PROJECTION: 	GENERAL TOLERANCE .X = +/- 0.2 .XX = +/- 0.15	 WÜRTH ELEKTRONIK	DESCRIPTION: DISCLAIMER	SIZE A4
G								
F								
E								
D								
C				APPROVAL: JC	UNIT: MM	WERI PART NO: DISCLAIMER	SIZE A4	
B					SCALE:			
A	10-SEP-14	PDF	QL		SHEET: 3/3			
REV	DATE	FILE	BY		DRAW: QL			

D