

HiPerFAST™ IGBT with Diode Lightspeed Series

**IXGH 24N60CD1
IXGT 24N60CD1**

**$V_{CES} = 600 \text{ V}$
 $I_{C25} = 48 \text{ A}$
 $V_{CE(sat)} = 2.5 \text{ V}$**

Preliminary data

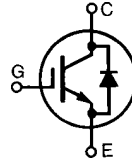

Symbol	Test Conditions	Maximum Ratings	
V_{CES}	$T_J = 25^\circ\text{C}$ to 150°C	600	V
V_{CGR}	$T_J = 25^\circ\text{C}$ to 150°C ; $R_{GE} = 1 \text{ M}\Omega$	600	V
V_{GES}	Continuous	± 20	V
V_{GEM}	Transient	± 30	V
I_{C25}	$T_C = 25^\circ\text{C}$	48	A
I_{C110}	$T_C = 110^\circ\text{C}$	24	A
I_{CM}	$T_C = 25^\circ\text{C}$, 1 ms	80	A
SSOA (RBSOA)	$V_{GE} = 15 \text{ V}$, $T_{VJ} = 125^\circ\text{C}$, $R_G = 22 \Omega$ Clamped inductive load, $L = 100 \mu\text{H}$	$I_{CM} = 48$ @ $0.8 V_{CES}$	A
P_C	$T_C = 25^\circ\text{C}$	150	W
T_J		-55 ... +150	$^\circ\text{C}$
T_{JM}		150	$^\circ\text{C}$
T_{stg}		-55 ... +150	$^\circ\text{C}$
Maximum lead temperature for soldering 1.6 mm (0.062 in.) from case for 10 s		300	$^\circ\text{C}$
M_d	Mounting torque (M3)	1.13/10 Nm/lb.in.	
Weight		TO-247	6 g
		TO-268	4 g

**TO-268
(IXGT)**

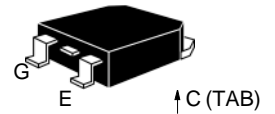

**TO-247 AD
(IXGH)**

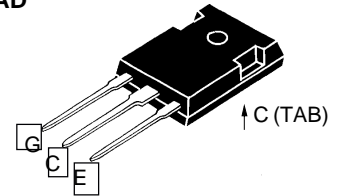

G = Gate, C = Collector,
E = Emitter, TAB = Collector

Features

- International standard packages JEDEC TO-247 and surface mountable TO-268
- High frequency IGBT
- High current handling capability
- Latest generation HDMOS™ process
- MOS Gate turn-on
 - drive simplicity
- Fast recovery epitaxial Diode (FRED)
 - soft recovery with low I_{RM}

Applications

- PFC circuits
- Uninterruptible power supplies (UPS)
- Switched-mode and resonant-mode power supplies
- AC motor speed control
- DC servo and robot drives
- DC choppers

Advantages

- High power density
- Very fast switching speeds for high frequency applications

Symbol	Test Conditions	Characteristic Values ($T_J = 25^\circ\text{C}$, unless otherwise specified)		
		min.	typ.	max.
BV_{CES}	$I_C = 750 \mu\text{A}$, $V_{GE} = 0 \text{ V}$	600		V
$V_{GE(th)}$	$I_C = 250 \mu\text{A}$, $V_{CE} = V_{GE}$	2.5		5.5 V
I_{CES}	$V_{CE} = 0.8 \cdot V_{CES}$ $V_{GE} = 0 \text{ V}$			$T_J = 25^\circ\text{C}$: 200 μA $T_J = 150^\circ\text{C}$: 3 mA
I_{GES}	$V_{CE} = 0 \text{ V}$, $V_{GE} = \pm 20 \text{ V}$			$\pm 100 \text{ nA}$
$V_{CE(sat)}$	$I_C = I_{C110}$, $V_{GE} = 15 \text{ V}$		2.1	2.5 V

Symbol	Test Conditions	Characteristic Values ($T_J = 25^\circ\text{C}$, unless otherwise specified)			
		min.	typ.	max.	
g_{fs}	$I_C = I_{C110}$; $V_{CE} = 10\text{ V}$, Pulse test, $t \leq 300\ \mu\text{s}$, duty cycle $\leq 2\%$	9	17	S	
C_{ies}	$V_{CE} = 25\text{ V}$, $V_{GE} = 0\text{ V}$, $f = 1\text{ MHz}$		1500	pF	
C_{oes}			170	pF	
C_{res}			40	pF	
Q_g	$I_C = I_{C110}$, $V_{GE} = 15\text{ V}$, $V_{CE} = 0.5 V_{CES}$		55	nC	
Q_{ge}			13	nC	
Q_{gc}			17	nC	
$t_{d(on)}$	Inductive load, $T_J = 25^\circ\text{C}$ $I_C = I_{C110}$, $V_{GE} = 15\text{ V}$, $L = 100\ \mu\text{H}$, $V_{CE} = 0.8 V_{CES}$, $R_G = R_{off} = 10\ \Omega$ Remarks: Switching times may increase for V_{CE} (Clamp) $> 0.8 \cdot V_{CES}$, higher T_J or increased R_G		15	ns	
t_{ri}			25	ns	
$t_{d(off)}$			75	140	ns
t_{fi}			60	110	ns
E_{off}			0.24	0.36	mJ
$t_{d(on)}$	Inductive load, $T_J = 125^\circ\text{C}$ $I_C = I_{C110}$, $V_{GE} = 15\text{ V}$, $L = 100\ \mu\text{H}$, $V_{CE} = 0.8 V_{CES}$, $R_G = R_{off} = 10\ \Omega$ Remarks: Switching times may increase for V_{CE} (Clamp) $> 0.8 \cdot V_{CES}$, higher T_J or increased R_G		15	ns	
t_{ri}			25	ns	
E_{on}			1	mJ	
$t_{d(off)}$			130	ns	
t_{fi}			110	ns	
E_{off}		0.6	mJ		
R_{thJC}				0.83 K/W	
R_{thCK}	(TO-247)		0.25	K/W	

Symbol	Test Conditions	Characteristic Values ($T_J = 25^\circ\text{C}$, unless otherwise specified)		
		min.	typ.	max.
V_F	$I_F = I_{C110}$, $V_{GE} = 0\text{ V}$, Pulse test, $t \leq 300\ \mu\text{s}$, duty cycle $d \leq 2\%$	$T_J = 150^\circ\text{C}$	1.6	V
		$T_J = 25^\circ\text{C}$	2.5	V
I_{RM}	$I_F = I_{C110}$, $V_{GE} = 0\text{ V}$, $-di_F/dt = 100\text{ A}/\mu\text{s}$ $V_R = 100\text{ V}$ $I_F = 1\text{ A}$; $-di/dt = 100\text{ A}/\mu\text{s}$; $V_R = 30\text{ V}$	$T_J = 100^\circ\text{C}$	6	A
t_{rr}		$T_J = 100^\circ\text{C}$	100	ns
		$T_J = 25^\circ\text{C}$	25	ns
R_{thJC}				0.9 K/W

Min. Recommended Footprint

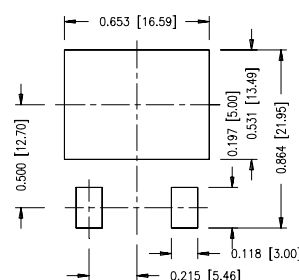

TO-247 AD (IXGH) Outline

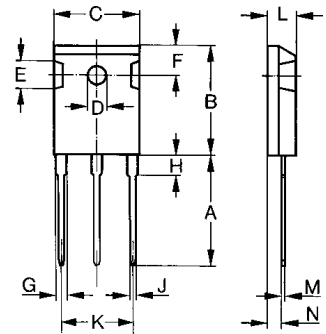

Dim.	Millimeter		Inches	
	Min.	Max.	Min.	Max.
A	19.81	20.32	0.780	0.800
B	20.80	21.46	0.819	0.845
C	15.75	16.26	0.610	0.640
D	3.55	3.65	0.140	0.144
E	4.32	5.49	0.170	0.216
F	5.4	6.2	0.212	0.244
G	1.65	2.13	0.065	0.084
H	-	4.5	-	0.177
J	1.0	1.4	0.040	0.055
K	10.8	11.0	0.426	0.433
L	4.7	5.3	0.185	0.209
M	0.4	0.8	0.016	0.031
N	1.5	2.49	0.087	0.102

TO-268AA (D³ PAK)

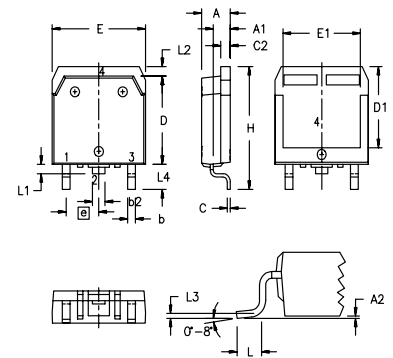

Dim.	Millimeter		Inches	
	Min.	Max.	Min.	Max.
A	4.9	5.1	.193	.201
A ₁	2.7	2.9	.106	.114
A ₂	.02	.25	.001	.010
b	1.15	1.45	.045	.057
b ₂	1.9	2.1	.75	.83
C	.4	.65	.016	.026
D	13.80	14.00	.543	.551
E	15.85	16.05	.624	.632
E ₁	13.3	13.6	.524	.535
e	5.45 BSC		.215 BSC	
H	18.70	19.10	.736	.752
L	2.40	2.70	.094	.106
L ₁	1.20	1.40	.047	.055
L ₂	1.00	1.15	.039	.045
L ₃	0.25 BSC		.010 BSC	
L ₄	3.80	4.10	.150	.161

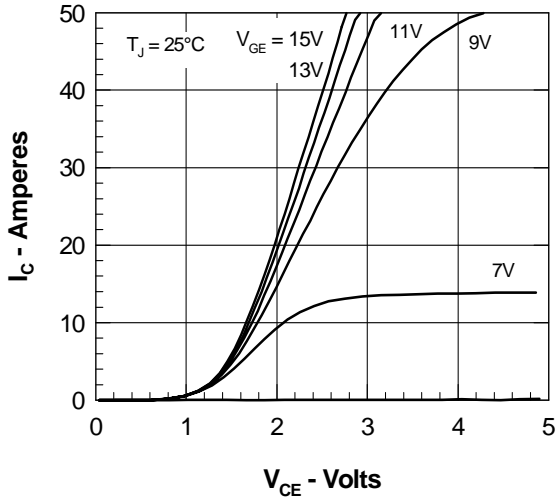

Fig. 1 Saturation Voltage Characteristics

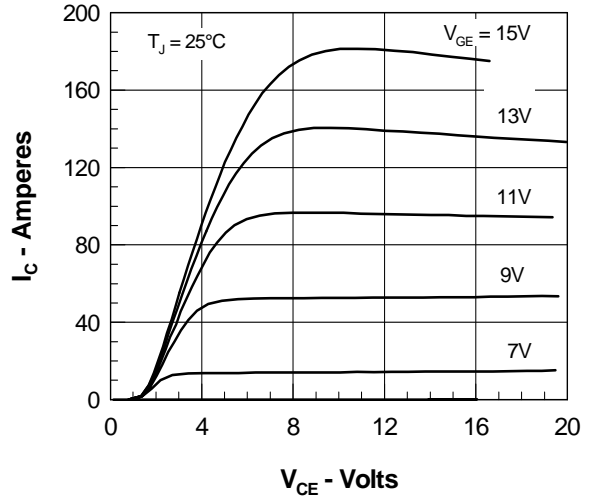

Fig. 2 Extended Output Characteristics

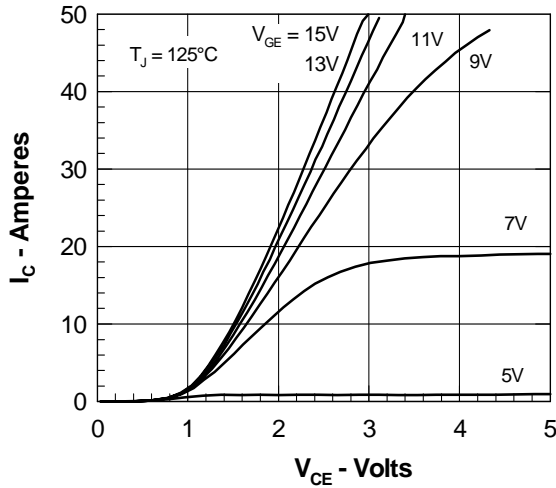

Fig. 3 Saturation Voltage Characteristics

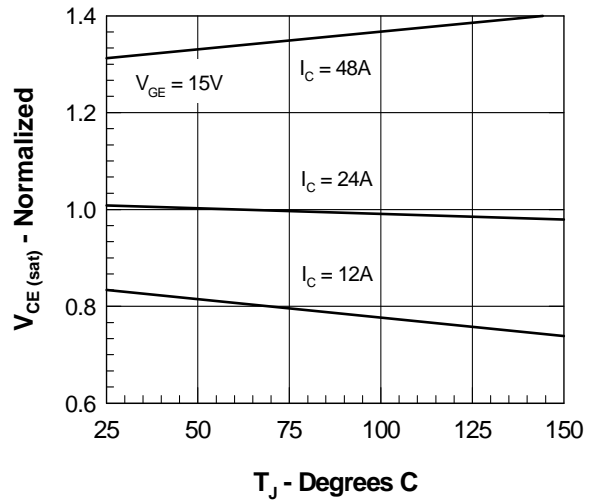

Fig. 4 Temperature Dependence of $V_{CE(sat)}$

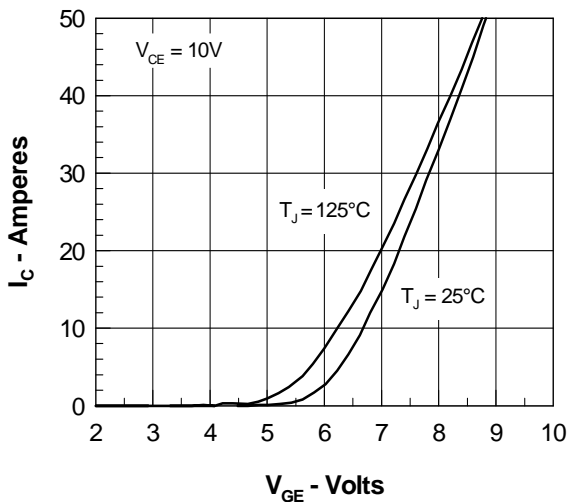

Fig. 5 Admittance Curves

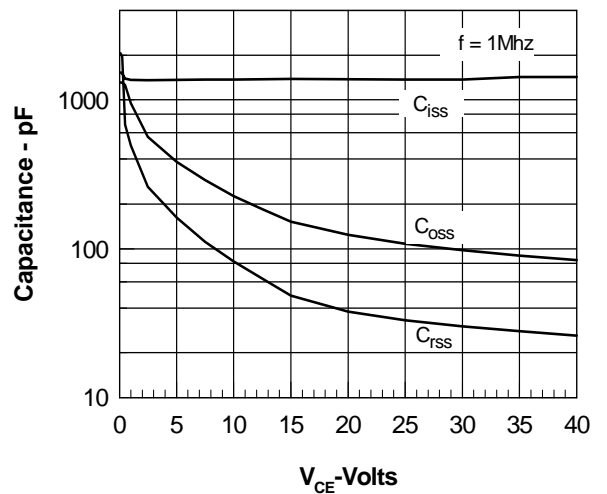

Fig. 6 Temperature Dependence of V_F & V_F

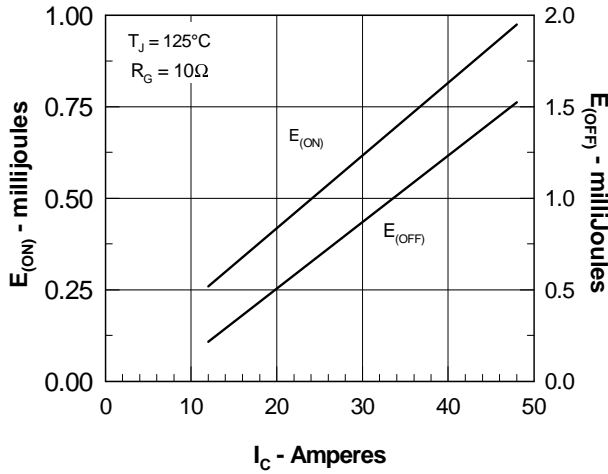

Fig.7. Dependence of E_{ON} and E_{OFF} on I_C

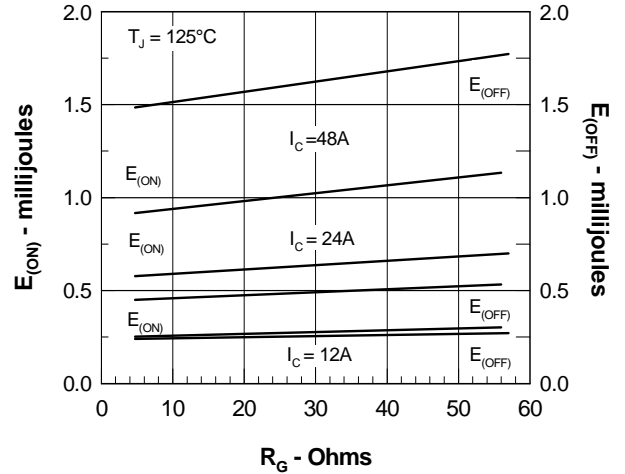

Fig.8. Dependence of E_{OFF} on R_G

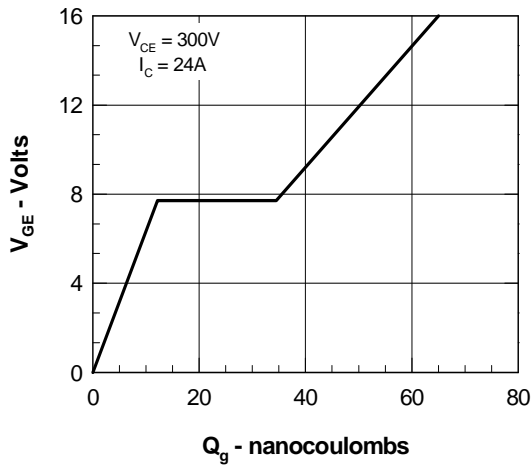

Fig.9. Gate Charge

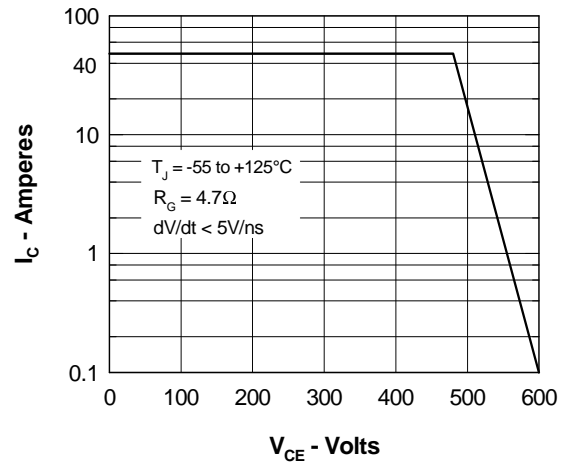

Fig.10. Turn-off Safe Operating Area

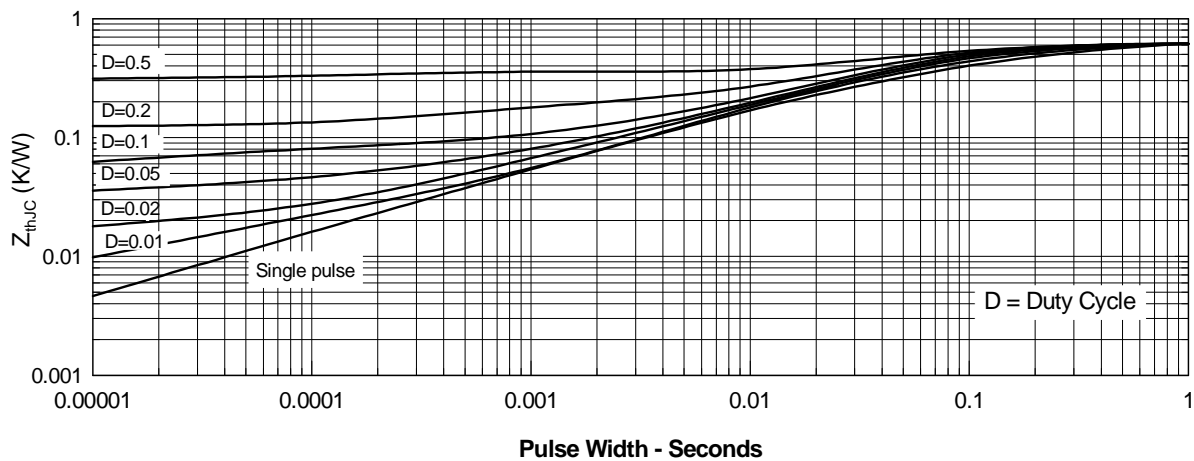

Fig. 11 IGBT Transient Thermal Resistance

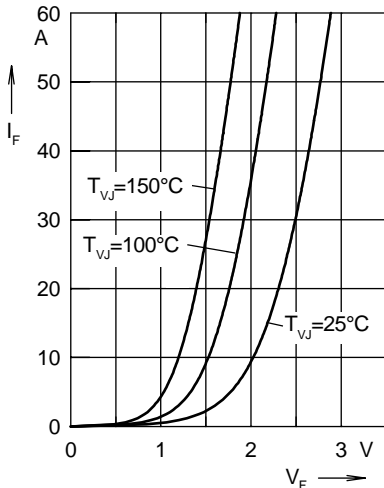

Fig. 12 Forward current I_F versus V_F

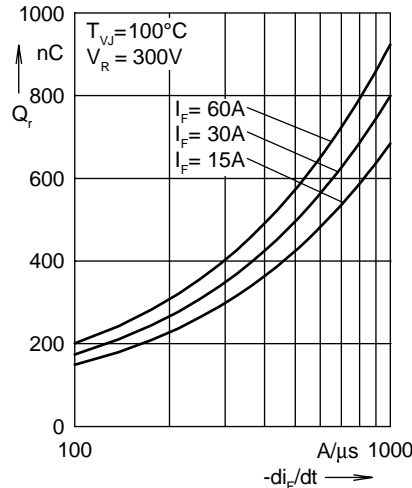

Fig. 13 Reverse recovery charge Q_r versus $-di_F/dt$

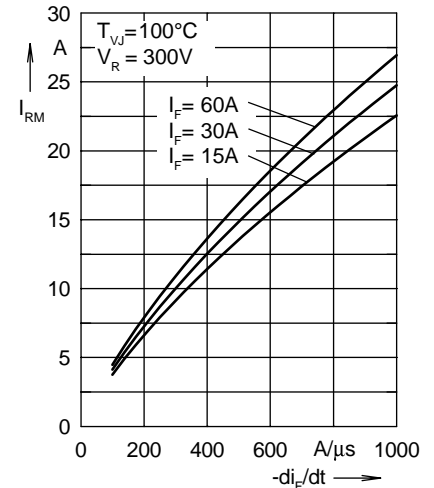

Fig. 14 Peak reverse current I_{RM} versus $-di_F/dt$

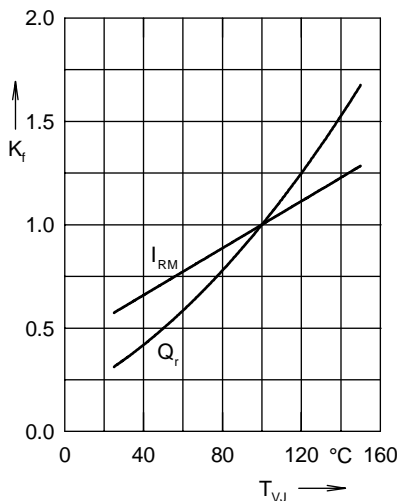

Fig. 15 Dynamic parameters Q_r and I_{RM} versus T_{VJ} temperature

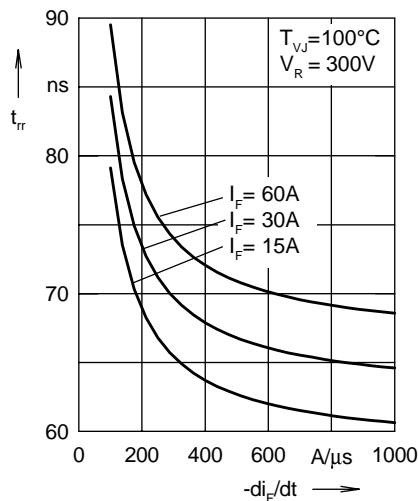

Fig. 16 Recovery time t_{rr} versus $-di_F/dt$

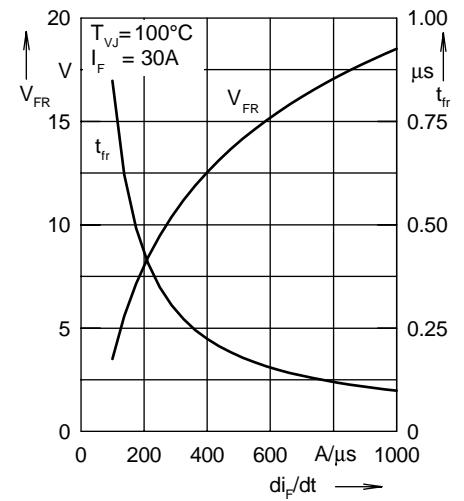

Fig. 17 Peak forward voltage V_{FR} and t_{fr} versus di_F/dt

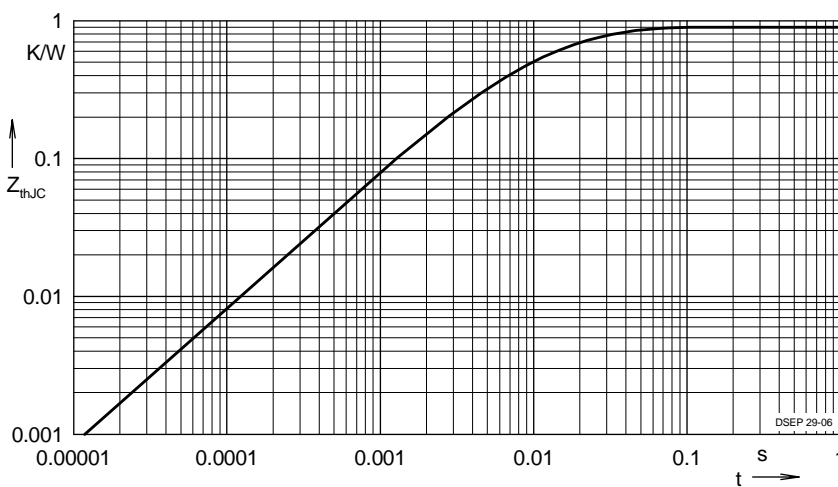

Fig. 18 Transient thermal resistance junction to case

Constants for Z_{thJC} calculation:

i	R_{thi} (K/W)	t_i (s)
1	0.502	0.0052
2	0.193	0.0003
3	0.205	0.0162