

Parameter	Value
V_{CC}	-50V
$I_{C(MAX.)}$	-500mA
R_1	4.7k Ω
R_2	4.7k Ω

●Features

- 1) Built-in bias resistors enable the configuration of an inverter circuit without connecting external input resistors. (see equivalent circuit)
- 2) The bias resistors consist of thin-film resistors with complete isolation to allow positive

biasing of the input. They also have the advantage of almost completely eliminating parasitic effects.

- 3) Only the on/off conditions need to be set for operation, making the device design easy.

●Application

INVERTER, INTERFACE, DRIVER

●Packaging specifications

Part No.	Package	Package size	Taping code	Reel size (mm)	Tape width (mm)	Basic ordering unit.(pcs)	Marking
DTB143EK	SMT3	2928	T146	180	8	3000	F13

●Outline

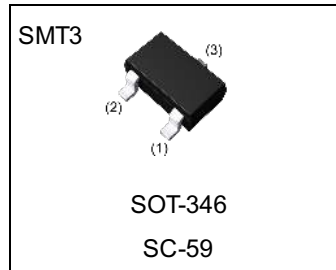

●Inner circuit

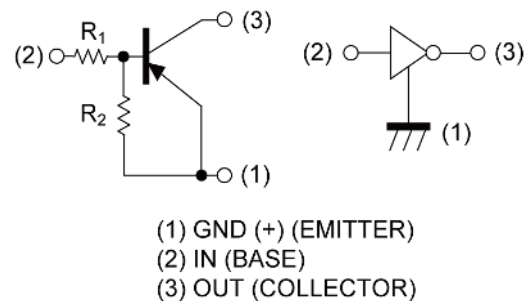

● **Absolute maximum ratings** ($T_a = 25^\circ\text{C}$)

Parameter	Symbol	Values	Unit
Supply voltage	V_{CC}	-50	V
Input voltage	V_{IN}	-30 to 10	V
Collector current	$I_{C(MAX)}^{*1}$	-500	mA
Power dissipation	P_D^{*2}	200	mW
Junction temperature	T_j	150	$^\circ\text{C}$
Range of storage temperature	T_{stg}	-55 to +150	$^\circ\text{C}$

● **Electrical characteristics** ($T_a = 25^\circ\text{C}$)

Parameter	Symbol	Conditions	Values			Unit
			Min.	Typ.	Max.	
Input voltage	$V_{I(off)}$	$V_{CC} = -5V, I_O = -100\mu\text{A}$	-	-	-0.5	V
	$V_{I(on)}$	$V_O = -0.3V, I_O = -20\text{mA}$	-3.0	-	-	
Output voltage	$V_{O(on)}$	$I_O / I_I = -50\text{mA} / -2.5\text{mA}$	-	-100	-300	mV
Input current	I_I	$V_I = -5V$	-	-	-1.8	mA
Output current	$I_{O(off)}$	$V_{CC} = -50V, V_I = 0V$	-	-	-500	nA
DC current gain	G_I	$V_O = -5V, I_O = -50\text{mA}$	47	-	-	-
Input resistance	R_I	-	3.29	4.7	6.11	k Ω
Resistance ratio	R_2/R_1	-	0.8	1.0	1.2	-
Transition frequency	f_T^{*1}	$V_{CE} = -10V, I_E = 50\text{mA}, f = 100\text{MHz}$	-	200	-	MHz

*1 Characteristics of built-in transistor

*2 Each terminal mounted on a reference land

● Electrical characteristic curves ($T_a = 25^\circ\text{C}$)

Fig.1 Input Voltage vs. Output Current (ON Characteristics)

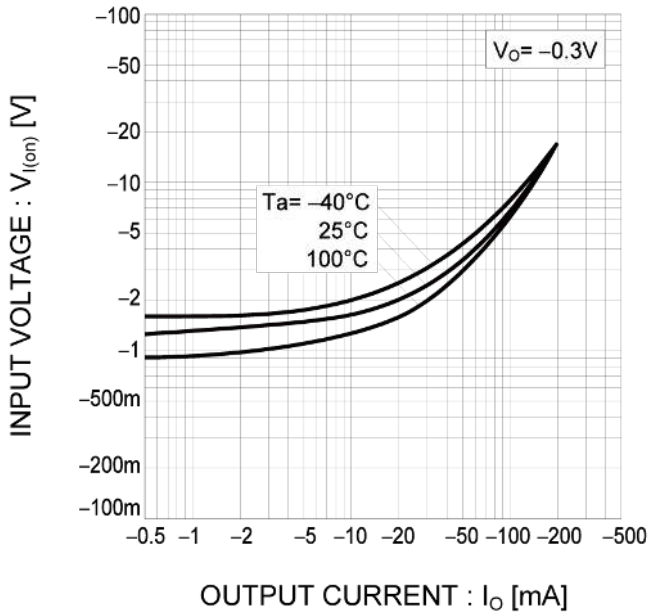

Fig.2 Output Current vs. Input Voltage (OFF Characteristics)

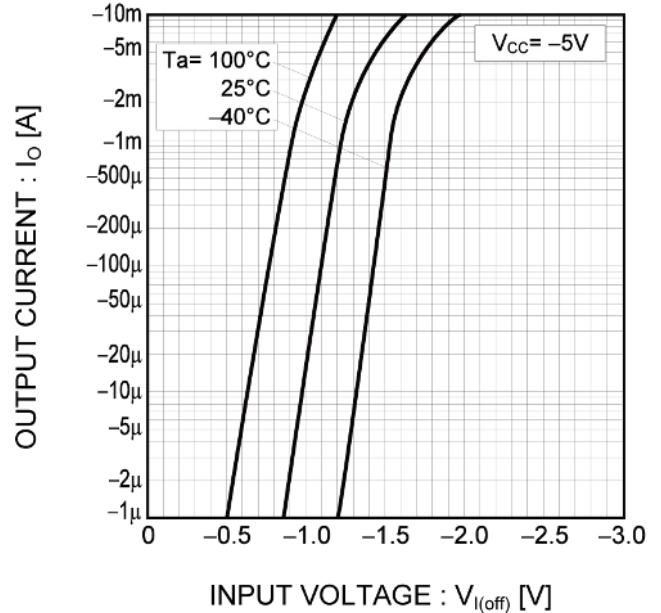

Fig.3 Output Current vs. Output Voltage

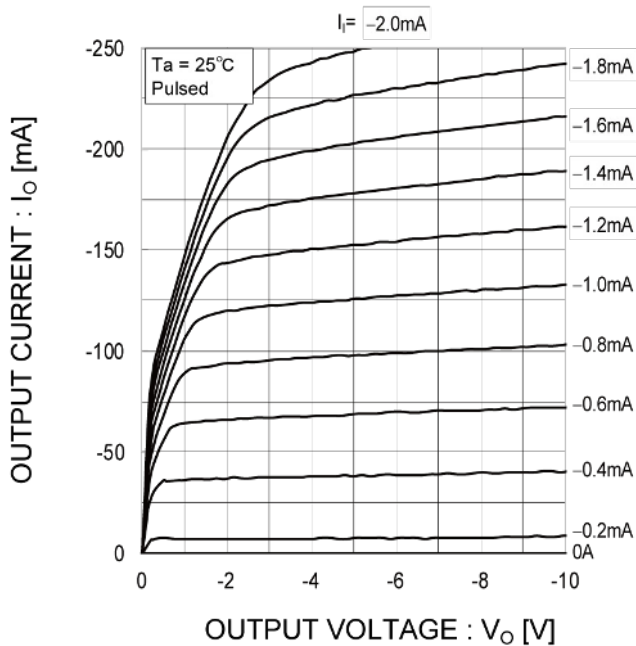
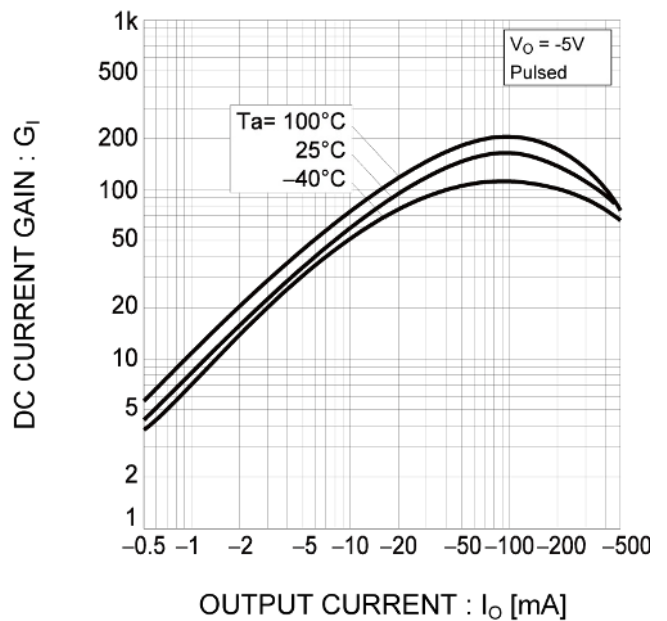
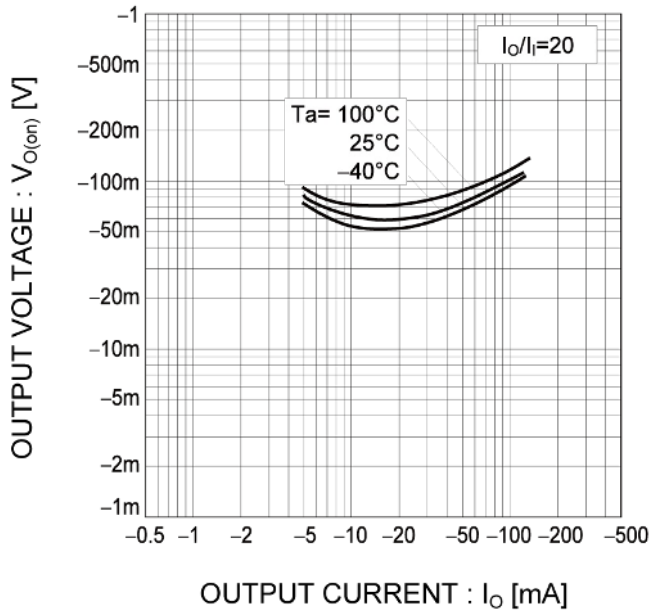

Fig.4 DC Current Gain vs. Output Current



● Electrical characteristic curves ($T_a = 25^\circ\text{C}$)

Fig.5 Output Voltage vs. Output Current



●Dimensions

SMT3

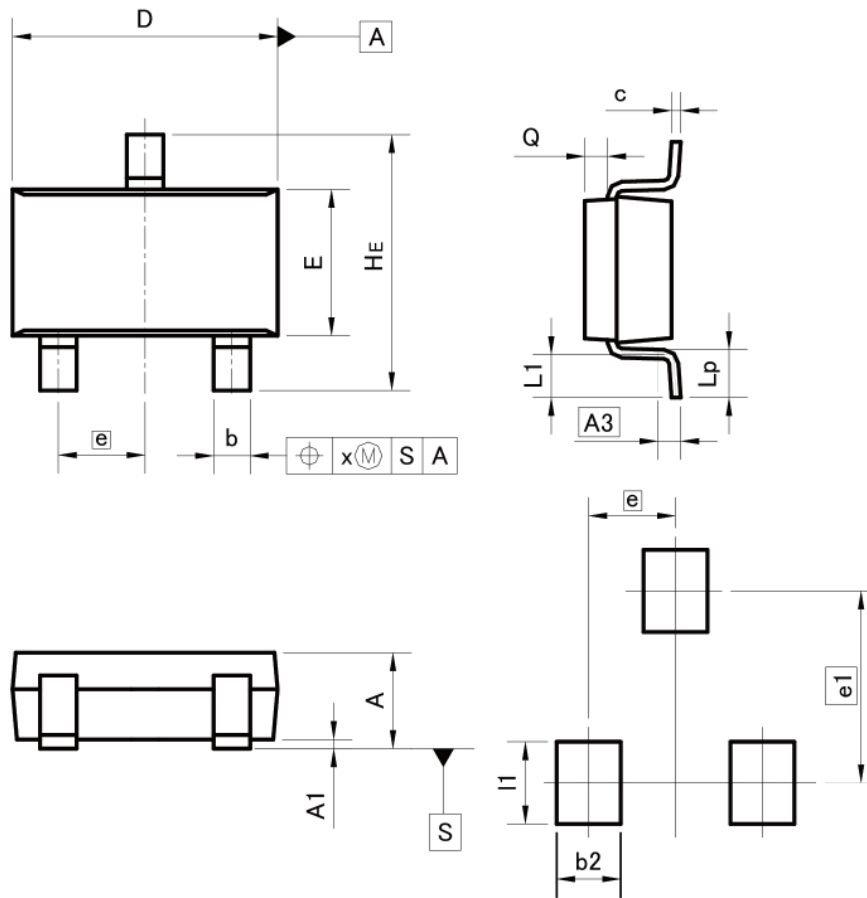

Pattern of terminal position areas
[Not a recommended pattern of soldering pads]

DIM	MILIMETERS		INCHES	
	MIN	MAX	MIN	MAX
A	1.00	1.30	0.039	0.051
A1	0.00	0.10	0.000	0.004
A3	0.25		0.010	
b	0.35	0.50	0.014	0.020
c	0.09	0.25	0.004	0.010
D	2.80	3.00	0.110	0.118
E	1.50	1.80	0.059	0.071
e	0.95		0.037	
HE	2.60	3.00	0.102	0.118
L1	0.30	0.60	0.012	0.024
Lp	0.40	0.70	0.016	0.028
Q	0.20	0.30	0.008	0.012
x	-	0.10	-	0.004
y	-	0.10	-	0.004

DIM	MILIMETERS		INCHES	
	MIN	MAX	MIN	MAX
b2	-	0.60	-	0.024
e1	2.10		0.083	
l1	-	0.90	-	0.035

Dimension in mm/inches

Notes

- 1) The information contained herein is subject to change without notice.
- 2) Before you use our Products, please contact our sales representative and verify the latest specifications :
- 3) Although ROHM is continuously working to improve product reliability and quality, semiconductors can break down and malfunction due to various factors. Therefore, in order to prevent personal injury or fire arising from failure, please take safety measures such as complying with the derating characteristics, implementing redundant and fire prevention designs, and utilizing backups and fail-safe procedures. ROHM shall have no responsibility for any damages arising out of the use of our Products beyond the rating specified by ROHM.
- 4) Examples of application circuits, circuit constants and any other information contained herein are provided only to illustrate the standard usage and operations of the Products. The peripheral conditions must be taken into account when designing circuits for mass production.
- 5) The technical information specified herein is intended only to show the typical functions of and examples of application circuits for the Products. ROHM does not grant you, explicitly or implicitly, any license to use or exercise intellectual property or other rights held by ROHM or any other parties. ROHM shall have no responsibility whatsoever for any dispute arising out of the use of such technical information.
- 6) The Products are intended for use in general electronic equipment (i.e. AV/OA devices, communication, consumer systems, gaming/entertainment sets) as well as the applications indicated in this document.
- 7) The Products specified in this document are not designed to be radiation tolerant.
- 8) For use of our Products in applications requiring a high degree of reliability (as exemplified below), please contact and consult with a ROHM representative : transportation equipment (i.e. cars, ships, trains), primary communication equipment, traffic lights, fire/crime prevention, safety equipment, medical systems, servers, solar cells, and power transmission systems.
- 9) Do not use our Products in applications requiring extremely high reliability, such as aerospace equipment, nuclear power control systems, and submarine repeaters.
- 10) ROHM shall have no responsibility for any damages or injury arising from non-compliance with the recommended usage conditions and specifications contained herein.
- 11) ROHM has used reasonable care to ensure the accuracy of the information contained in this document. However, ROHM does not warrants that such information is error-free, and ROHM shall have no responsibility for any damages arising from any inaccuracy or misprint of such information.
- 12) Please use the Products in accordance with any applicable environmental laws and regulations, such as the RoHS Directive. For more details, including RoHS compatibility, please contact a ROHM sales office. ROHM shall have no responsibility for any damages or losses resulting non-compliance with any applicable laws or regulations.
- 13) When providing our Products and technologies contained in this document to other countries, you must abide by the procedures and provisions stipulated in all applicable export laws and regulations, including without limitation the US Export Administration Regulations and the Foreign Exchange and Foreign Trade Act.
- 14) This document, in part or in whole, may not be reprinted or reproduced without prior consent of ROHM.



Thank you for your accessing to ROHM product informations.
More detail product informations and catalogs are available, please contact us.

ROHM Customer Support System

<http://www.rohm.com/contact/>