



# WLA26P-24116100ZZZ

## W26

COMPACT PHOTOELECTRIC SENSORS

**SICK**  
Sensor Intelligence.



Illustration may differ



### Ordering information

| Type               | Part no. |
|--------------------|----------|
| WLA26P-24116100ZZZ | 1222792  |

Other models and accessories → [www.sick.com/W26](http://www.sick.com/W26)

### Detailed technical data

#### Features

|   |                                       |
|---|---------------------------------------|
| <b>Functional principle</b>   | Photoelectric retro-reflective sensor |
| <b>Functional principle detail</b>  | Autocollimation                       |
| <b>Sensing range</b>  |                                       |
| Sensing range min.  | 0 m                                   |
| Sensing range max.  | 18 m                                  |
| Maximum distance range from reflector to sensor (operating reserve 1)                           | 0 m ... 18 m                          |
| Recommended distance range from reflector to sensor (operating reserve 3,75)                    | 0 m ... 12 m                          |
| Reference reflector   | Reflector PL80A                       |
| Recommended sensing range for the best performance  | 0 m ... 12 m                          |
| <b>Polarisation filters</b>   | Yes                                   |
| <b>Emitted beam</b>   |                                       |
| Light source  | PinPoint LED                          |
| Type of light   | Visible red light                     |
| Shape of light spot   | Point-shaped                          |
| Light spot size (distance)  | Ø 100 mm (10 m)                       |
| Maximum dispersion of the emitted beam around the standardized transmission axis (squint angle) | < +/- 1.0° (at Ta = +23 °C)           |
| <b>Key LED figures</b>  |                                       |

|                             |  |
|-----------------------------|--|
| Normative reference         | EN 62471:2008-09   IEC 62471:2006, modified  |
| LED risk group marking      | Free group   |
| Wave length                 | 635 nm   |
| Average service life        | 100,000 h at $T_a = +25\text{ °C}$   |
| <b>Indication</b>           |  |
| LED blue                    | BluePilot: Alignment aid   |
| LED green                   | Operating indicator<br>Static on: power on   |
| LED yellow                  | Status of received light beam<br>Static on: object not present<br>Static off: object present<br>Flashing: Below the 1.5 function reserve |
| <b>Special applications</b> | Detecting objects wrapped in film  |

### Safety-related parameters

|                                     |  |
|-------------------------------------|--|
| <b>MTTF<sub>D</sub></b>             | 693 years                                    |
| <b>DC<sub>avg</sub></b>             | 0 %  |
| <b>T<sub>M</sub> (mission time)</b> | 20 years (EN ISO 13849)<br>Rate of use: 60 % |

### Electrical data

|                                     |  |
|-------------------------------------|--|
| <b>Supply voltage U<sub>B</sub></b> | 10 V DC ... 30 V DC <sup>1)</sup>                                      |
| <b>Ripple</b>                       | ≤ 5 V <sub>pp</sub>  |
| <b>Usage category</b>               | DC-12 (According to EN 60947-5-2)<br>DC-13 (According to EN 60947-5-2) |
| <b>Current consumption</b>          | ≤ 30 mA, without load. At U <sub>B</sub> = 24 V <sup>2)</sup>          |
| <b>Protection class</b>             | III  |
| <b>Digital output</b>               |  |
| Number                              | 2 (Complementary)  |
| Type                                | Push-pull: PNP/NPN   |
| Signal voltage PNP HIGH/LOW         | Approx. U <sub>B</sub> -2.5 V / 0 V                                    |
| Signal voltage NPN HIGH/LOW         | Approx. U <sub>B</sub> / < 2.5 V                                       |
| Output current I <sub>max</sub>     | ≤ 100 mA   |
| Circuit protection outputs          | Reverse polarity protected<br>Overcurrent and short-circuit protected  |
| Response time                       | ≤ 500 μs <sup>3)</sup>   |
| Repeatability (response time)       | 150 μs   |
| Switching frequency                 | 1,000 Hz <sup>4)</sup>   |
| <b>Pin/Wire assignment</b>          |  |
| Function of pin 4/black (BK)        | Digital output, light switching, object present → output Q LOW         |
| Function of pin 2/white (WH)        | Digital output, health → output LOW                                    |

<sup>1)</sup> Limit values.

<sup>2)</sup> 10 V DC ... 16 V DC, without load.

<sup>3)</sup> Signal transit time with resistive load in switching mode.

<sup>4)</sup> With light/dark ratio 1:1.

## Mechanical data

|   |                             |
|---|-----------------------------|
| <b>Housing</b>  | Rectangular                 |
| <b>Dimensions (W x H x D)</b>                         | 24.6 mm x 82.5 mm x 53.3 mm |
| <b>Connection</b>                                     | Male connector M12, 4-pin   |
| <b>Material</b>                                       |                             |
| Housing   | Plastic, VISTAL®            |
| Front screen  | Plastic, PMMA               |
| Male connector  | Plastic, VISTAL®            |
| <b>Weight</b>   | Approx. 80 g                |
| <b>Maximum tightening torque of the fixing screws</b> | 1.3 Nm                      |

## Ambient data

|  |  |
|--|--|
| <b>Enclosure rating</b>                    | IP66 (EN 60529)<br>IP67 (EN 60529)<br>IP69 (EN 60529) <sup>1)</sup>  |
| <b>Ambient operating temperature</b>       | -40 °C ... +60 °C  |
| <b>Ambient temperature, storage</b>        | -40 °C ... +75 °C  |
| <b>Shock resistance</b>                    | 50 g, 11 ms (25 positive and 25 negative shocks per axis, for X, Y, Z axes, 150 shocks in total (EN60068-2-27))<br>50 g, 6 ms (5,000 positive and 5,000 negative shocks per axis, for X, Y, Z axes, 30,000 shocks in total (EN60068-2-27)) |
| <b>Vibration resistance</b>                | 10 Hz ... 2,000 Hz (Amplitude 0.5 mm / 10 g, 20 sweeps per axis, for X, Y, Z axes, 1 octave/min, (EN60068-2-6))  |
| <b>Air humidity</b>                        | 35 % ... 95 %, Relative humidity (no condensation)   |
| <b>Electromagnetic compatibility (EMC)</b> | EN 60947-5-2   |
| <b>Resistance to cleaning agent</b>        | ECOLAB   |
| <b>UL File No.</b>                         | NRKH.E181493 & NRKH7.E181493   |

<sup>1)</sup> Replaces IP69K with ISO 20653: 2013-03.

## Classifications

|                     |          |
|---------------------|----------|
| <b>eCl@ss 5.0</b>   | 27270902 |
| <b>eCl@ss 5.1.4</b> | 27270902 |
| <b>eCl@ss 6.0</b>   | 27270902 |
| <b>eCl@ss 6.2</b>   | 27270902 |
| <b>eCl@ss 7.0</b>   | 27270902 |
| <b>eCl@ss 8.0</b>   | 27270902 |
| <b>eCl@ss 8.1</b>   | 27270902 |
| <b>eCl@ss 9.0</b>   | 27270902 |
| <b>eCl@ss 10.0</b>  | 27270902 |
| <b>eCl@ss 11.0</b>  | 27270902 |
| <b>eCl@ss 12.0</b>  | 27270902 |
| <b>ETIM 5.0</b>     | EC002717 |
| <b>ETIM 6.0</b>     | EC002717 |
| <b>ETIM 7.0</b>     | EC002717 |
| <b>ETIM 8.0</b>     | EC002717 |

UNSPSC 16.0901

39121528

### Connection type

M12 male connector, 4-pin

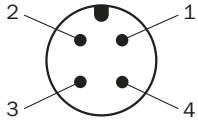

### Connection diagram

Cd-104

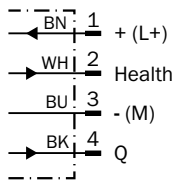

### Characteristic curve

Reflective tape

Operating reserve

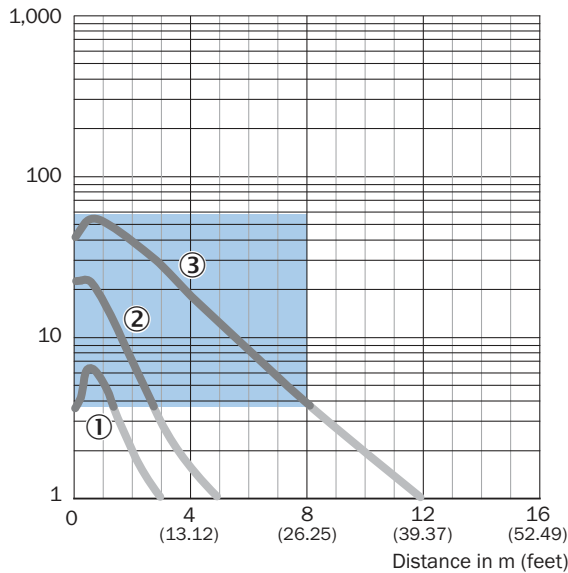

Recommended sensing range for the best performance

- ① Reflective tape REF-DG (50 x 50 mm)
- ② Reflective tape REF-IRF-56 (50 x 50 mm)
- ③ Reflective tape REF-AC1000 (50 x 50 mm)

### Standard reflectors

Operating reserve

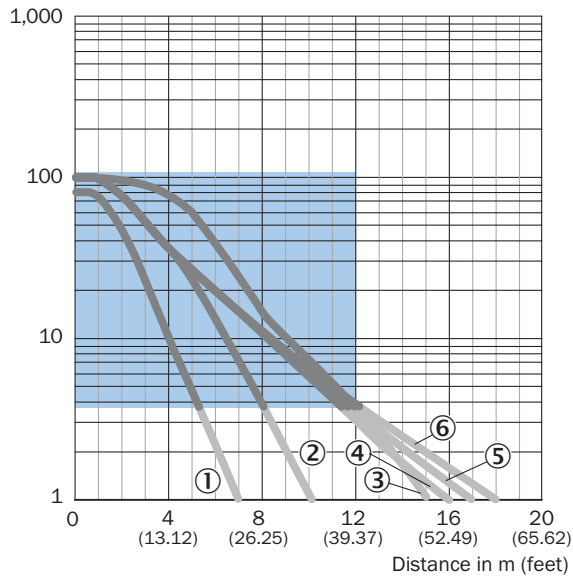

Recommended sensing range for the best performance

- ① Reflector PL20A
- ② Reflector PL22
- ③ Reflector PL250
- ④ Reflector PL30A
- ⑤ Reflector PL40A
- ⑥ Reflector PL80A, C110A

### Chemical-resistant reflectors

Operating reserve

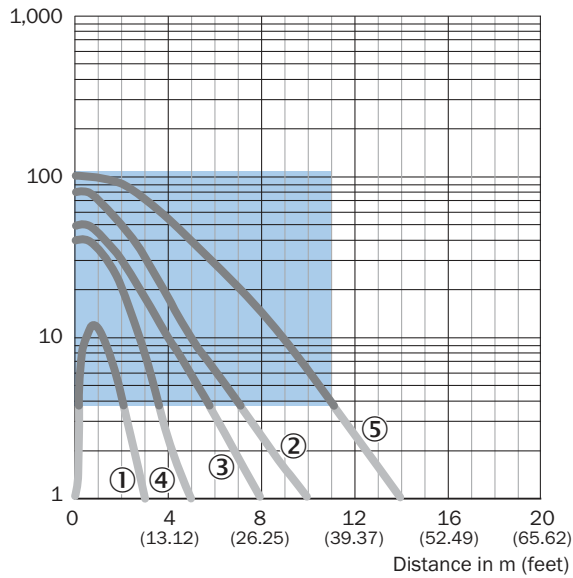

Recommended sensing range for the best performance

- ① PL10F CHEM reflector
- ② Reflector P250H
- ③ Reflector P250 CHEM
- ④ Reflector PL20 CHEM
- ⑤ Reflector PL40A Antifog

Fine triple reflectors

Operating reserve

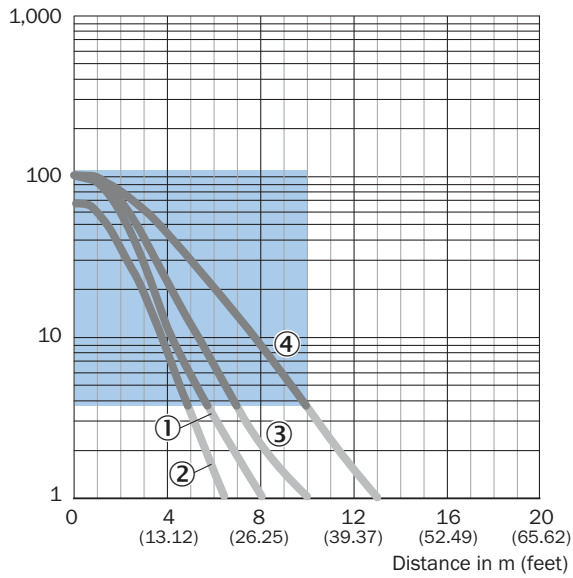

- Recommended sensing range for the best performance
- ① PL10FH-1 reflector
- ② PL10F reflector
- ③ Reflector PL20F
- ④ Reflector P250F

Light spot size

WLA26P-xxxx1xx

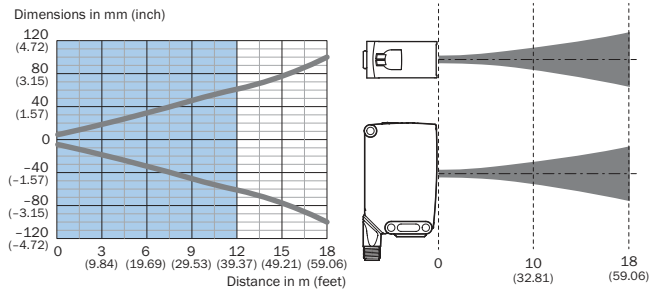

■ Recommended sensing range for the best performance

### Sensing range diagram

Standard reflectors

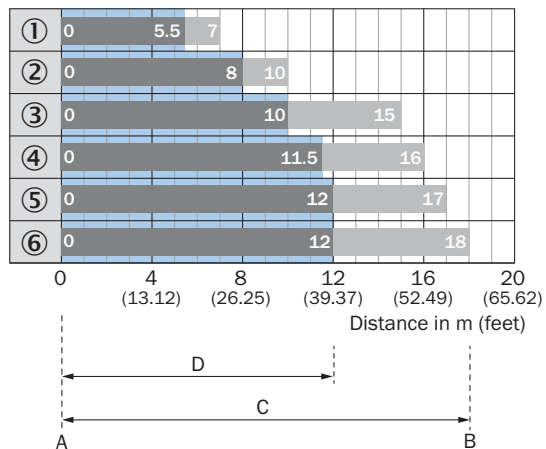

Recommended sensing range for the best performance

Reflective tape

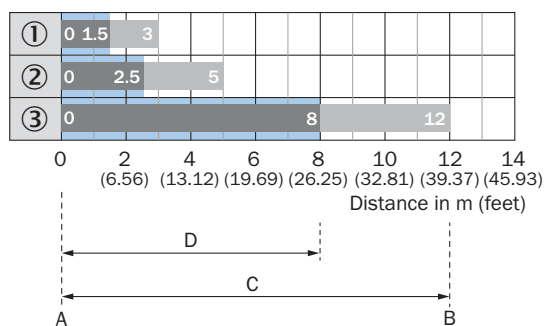

Recommended sensing range for the best performance

Fine triple reflectors

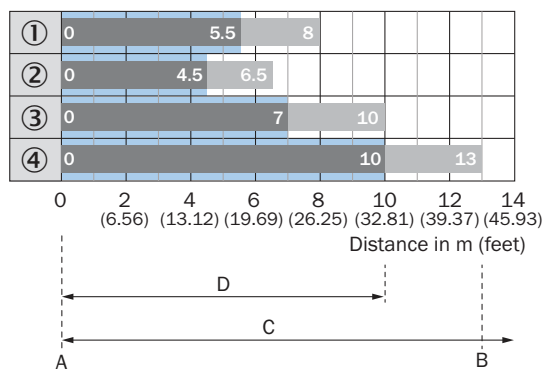

Recommended sensing range for the best performance



Chemical-resistant reflectors

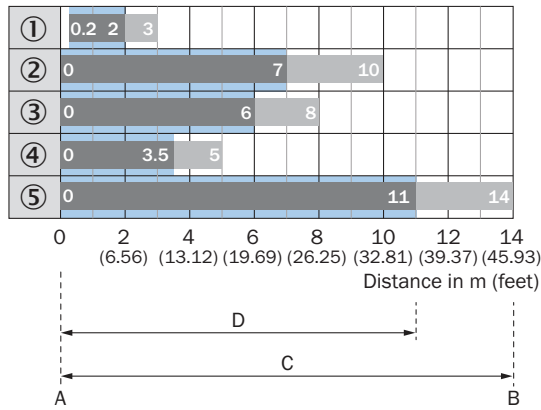

Recommended sensing range for the best performance

Functions

Operation note

BluePilot: Blue indicator LEDs with double benefits

|  |  |
|--|--|
| <p>Easy and quick sensor alignment with the help of the LED indicator</p> <ul style="list-style-type: none"> <li>All blue LEDs illuminate</li> <li>- optimum alignment</li> <li>- highest possible operating reserve</li> </ul>  | <p>WLA photoelectric retro-reflection sensor alignment</p> |
| <p><b>Service note</b><br/>                 A reduction in sensor availability is displayed by a decrease of the blue LEDs.</p> <p>Possible causes:</p> <ol style="list-style-type: none"> <li>insufficient alignment</li> <li>contamination of the optical surfaces</li> <li>particles in the light beam</li> </ol> |  |

Operation note

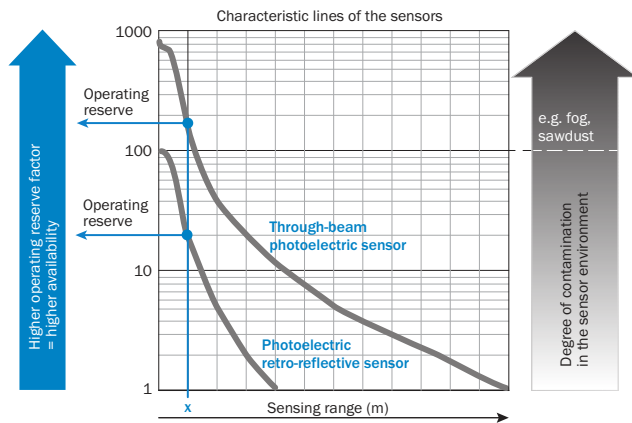

At a sensing range of „x“ the photoelectric retro-reflective and through-beam photoelectric sensors have different operating reserves (see blue arrow). The higher the operating reserve factor, the better the sensor can compensate the contamination in the air or in the light beam and on the optical surfaces (front screen, reflector), i.e. the sensor has the maximum availability, otherwise the sensor switches due to pollution although there is no object in the path of the light beam.

### Adjustments

Display and adjustment elements

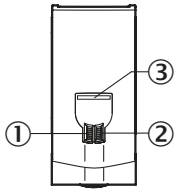

- ① LED indicator green
- ② LED indicator yellow
- ③ LED blue

### Dimensional drawing (Dimensions in mm (inch))

WLA26, connector

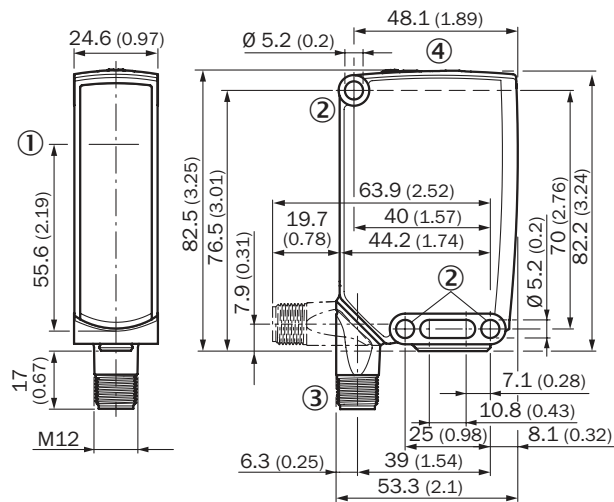



- ① Center of optical axis
- ② Mounting hole,  $\varnothing$  5.2 mm
- ③ Connection
- ④ Display and adjustment elements

### Recommended accessories

Other models and accessories → [www.sick.com/W26](http://www.sick.com/W26)

|                                     | Brief description  | Type        | Part no. |
|-------------------------------------|--|-------------|----------|
| <b>Universal bar clamp systems</b>  |  |             |          |
|                                     | Plate N12 for universal clamp. For mounting PL30A, P250 reflectors, W27 and WTR2 sensors., Zinc plated steel (sheet), Zinc die cast (clamping bracket), Universal clamp (2022726), mounting hardware | BEF-KHS-N12 | 2071950  |
| <b>Mounting brackets and plates</b> |  |             |          |
|                                     | Universal mounting bracket for reflectors, steel, zinc coated  | BEF-WN-REFX | 2064574  |

|   | Brief description   | Type               | Part no. |
|---|---|--------------------|----------|
| Plug connectors and cables  |   |                    |          |
|  | Head A: female connector, M12, 4-pin, straight, A-coded<br>Head B: Flying leads<br>Cable: Sensor/actuator cable, PVC, unshielded, 5 m | YF2A14-050VB3XLEAX | 2096235  |
|  | Head A: male connector, M12, 4-pin, straight<br>Cable: unshielded   | STE-1204-G         | 6009932  |
| Reflectors  |   |                    |          |
|  | Rectangular, screw connection, 84 mm x 84 mm, PMMA/ABS, Screw-on, 2 hole mounting   | PL80A              | 1003865  |

## SICK AT A GLANCE

SICK is one of the leading manufacturers of intelligent sensors and sensor solutions for industrial applications. A unique range of products and services creates the perfect basis for controlling processes securely and efficiently, protecting individuals from accidents and preventing damage to the environment.

We have extensive experience in a wide range of industries and understand their processes and requirements. With intelligent sensors, we can deliver exactly what our customers need. In application centers in Europe, Asia and North America, system solutions are tested and optimized in accordance with customer specifications. All this makes us a reliable supplier and development partner.

Comprehensive services complete our offering: SICK LifeTime Services provide support throughout the machine life cycle and ensure safety and productivity.

For us, that is “Sensor Intelligence.”

## WORLDWIDE PRESENCE:

Contacts and other locations [www.sick.com](http://www.sick.com)