

150 WATTS

SINGLE/MULTI OUTPUT DC-DC

FEATURES:

- Compact 3.8" x 5" x 1.3" Size
- 2 Year Warranty
- 36-72VDC Input
- One to Four Outputs
- 4242VDC Reinforced Insulation
- Under/Overtolerance Lockout
- Size/Pin Compatible with REL-150 Series
- IEC 60601-1 3rd ed. Medical Cert.
- IEC 62368-1 2nd ed. Certification
- 0-70°C Operating Temperature
- RoHS Compliant
- Optional Chassis/Cover
- Power Good Signal





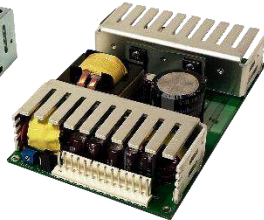

CHASSIS/COVER



OPEN FRAME

SAFETY SPECIFICATIONS

 Underwriters Laboratories File E137708/E140259	UL 62368-1:2014, 2 nd Edition CAN/CSA-C22.2 No. 62368-1-14 AAMI/ANSI ES60601-1:2005/(R) 2012 CAN/CSA-C22.2 No. 60601-1:2014
 CB Reports/Certificates (including all National and Group Deviations)	IEC 62368-1:2014, 2 nd Edition IEC 60601-1:2005/A1:2012
 TUV SUD America	EN 62368-1:2014, 2 nd Edition EN 60601-1:2006/A1:2013
 RoHS Directive (Recast)	(2015/863/EU of March 2015)
 Restriction of the Use of Certain Hazardous Substances in EEE Regulations 2012 SI No. 3032 + 2019 SI No.492	

MODEL LISTING

MODEL	OUTPUT 1 ₍₂₀₎	OUTPUT 2 ₍₂₀₎	OUTPUT 3 ₍₁₉₎	OUTPUT 4 ₍₁₉₎
DC4-150-4001	+3.3V/15A ₍₁₇₎	+5V/8A	+12V/2A	-12V/2A
DC4-150-4002	+5V/15A ₍₁₇₎	+3.3V/8A	+12V/2A	-12V/2A
DC4-150-4003	+5V/15A ₍₁₇₎	+3.3V/8A	+15V/2A	-15V/2A
DC4-150-4004	+5V/15A ₍₁₇₎	-5V/8A	+12V/2A	-12V/2A
DC4-150-4005	+5V/15A ₍₁₇₎	-5V/8A	+15V/2A	-15V/2A
DC4-150-4006	+5V/15A ₍₁₇₎	+24V/3A	+12V/2A	-12V/2A
DC4-150-4007	+5V/15A ₍₁₇₎	+24V/3A	+15V/2A	-15V/2A
DC4-150-3001	+5V/15A ₍₁₇₎	+12V/4A		-12V/3A
DC4-150-3002	+5V/15A ₍₁₇₎	+15V/3A		-15V/2A
DC4-150-2001	+3.3V/15A ₍₁₇₎	+5V/8A		
DC4-150-2002	+5V/15A ₍₁₇₎	+12V/5A		
DC4-150-2003	+5V/15A ₍₁₇₎	+24V/3A		
DC4-150-2004	+12V/7.5A	-12V/5A		
DC4-150-2005	+15V/5A	-15V/5A		
DC4-150-1001	2.5V/30A ₍₁₈₎			
DC4-150-1002	3.3V/30A ₍₁₈₎			
DC4-150-1003	5V/30A ₍₁₈₎			
DC4-150-1004	12V/12.5A			
DC4-150-1005	15V/10.0A			
DC4-150-1006	24V/6.3A			
DC4-150-1007	28V/5.4A			
DC4-150-1008	48V/3.1A			

ORDERING INFORMATION

Consult factory for alternate output configurations.
Consult factory for positive, negative or floating outputs.
Please specify the following optional features when ordering:

- CH – Chassis
CO – Cover
BD – Reverse Input Protection
- I/O – Isolated Outputs
TS – Terminal Strip

DC4-150

OUTPUT SPECIFICATIONS

Total Output Power at 50°C ₍₁₎ (See Derating Chart)	100W 150W	Convection Cooled _(13, 15) 300LFM Forced-Air _(12, 14, 16)
Output Voltage Centering	Output 1: Output 2: Output 3: Output 4:	± 0.5% (All outputs at 50% load) ± 5.0% ± 5.0% ± 5.0%
Output Voltage Adjust Range	Output 1:	95 - 105%
Load Regulation	Output 1: Output 2: (4001-5 Models) (2001 Model) Output 3: Output 4:	0.5% (10-100% load change) 5.0% (10-100% load change) 8.0% (20-100% load change) 6.0% (20-100% load change) 5.0% (10-100% load change) 5.0% (10-100% load change)
Source Regulation	Outputs 1 – 4:	0.5%
Cross Regulation	Outputs 2 – 4:	5.0%
Output Noise	Outputs 1 – 4:	1.0%
Turn on Overshoot	None	
Transient Response	Outputs 1 – 4	
Voltage Deviation	5.0%	
Recovery Time	500µs	
Load Change	50% to 100%	
Output Overvoltage Protection	Output 1:	110% to 150%
Output Overpower Protection	110-160% rated Pout, cycle on/off, auto recovery	
Start Up Time	5 Seconds	

INPUT SPECIFICATIONS

Input Voltage Range	36-72 VDC
Input Under-Voltage Lockout	
Turn-On Voltage	29.0-35.0 VDC
Turn-off Voltage	28.0-34.0 VDC
Input Overvoltage Shutdown	77.0-85.0 VDC
Maximum Input Current	6.0 A
Reflected Ripple Current	5 %
Efficiency	82% Typ., Full Power, 48 VDC, varies by model

ENVIRONMENTAL SPECIFICATIONS

Ambient Operating	0°C to +70°C
Temperature Range	Derating: See Power Rating Chart
Ambient Storage Temp. Range	-40°C to +85°C
Temperature Coefficient	Outputs 1 – 4: 0.02%/°C
Altitude	3,000m ASL – Operating – Medical 60601-1 5,000m ASL – Operating – ITE/AV – 62368-1 12,192m ASL – Non-Operating

GENERAL SPECIFICATIONS

Means of Protection	
Primary to Secondary	2MOOP (Means of Operator Protection)
Primary to Ground	1MOOP (Means of Operator Protection)
Secondary to Ground	Operational Insulation(Consult factory for 1MOPP)
Dielectric Strength _(7, 8)	
Reinforced Insulation	4242 VDC, Primary to Secondary
Basic Insulation	2121 VDC, Primary to Ground
Operational Insulation	707 VDC, Secondary to Ground
Power Good Signal ₍₁₁₎	Logic high with input voltage above Vin min.
Remote Sense ₍₉₎	250mV compensation of output cable losses
Mean-Time Between Failures	100,000 Hours min., MIL-HDBK-217F, 25° C, GB
Weight	0.90 Lbs. Open Frame 1.60 Lbs. Chassis and Cover

EMC SPECIFICATIONS

Electrostatic Discharge	EN61000-4-2	±8KV contact/ ±15KV air discharge	A
Electrical Fast Transients/Bursts	EN61000-4-4	±2KV, 5KHz/100KHz	A
Surge Immunity	EN61000-4-5	±2KV line to earth/ ±1KV line to line	A

MAXIMUM OUTPUT POWER vs. AMBIENT TEMPERATURE

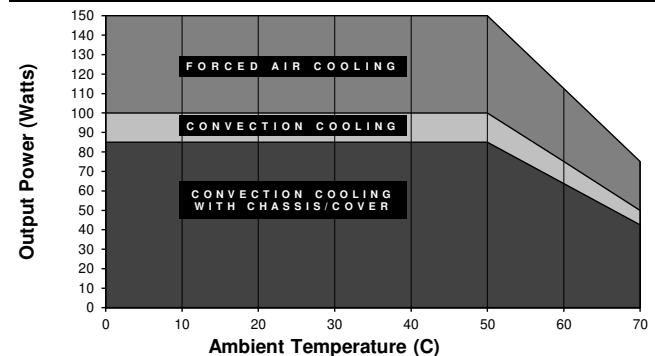

All specifications are maximum at 25°C/150W unless otherwise stated, may vary by model and are subject to change without notice.

DC4-150 SERIES MECHANICAL SPECIFICATIONS

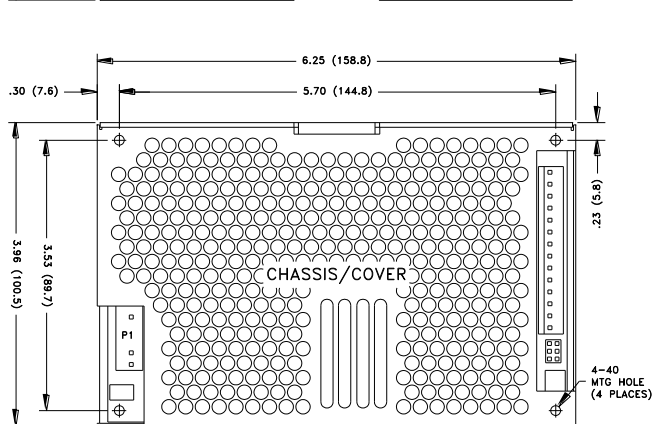
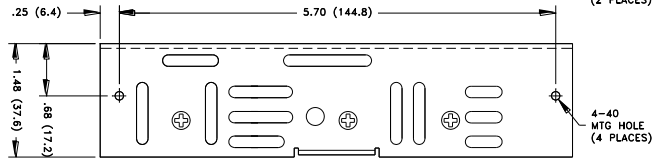
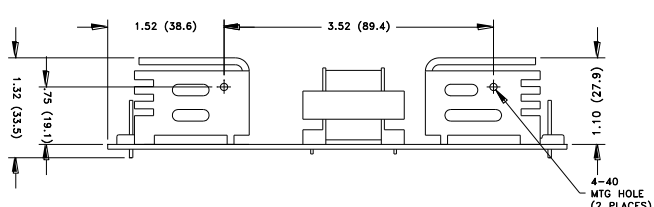
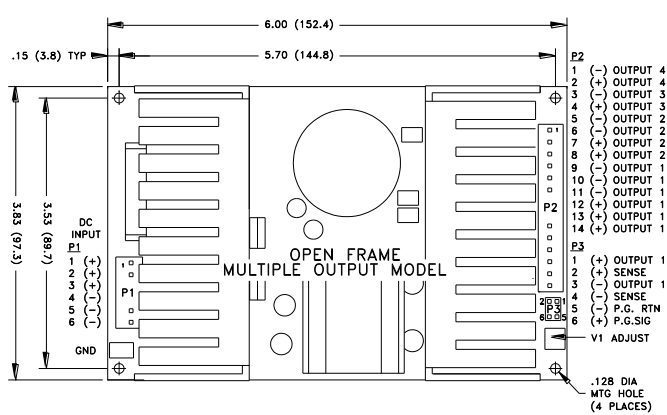
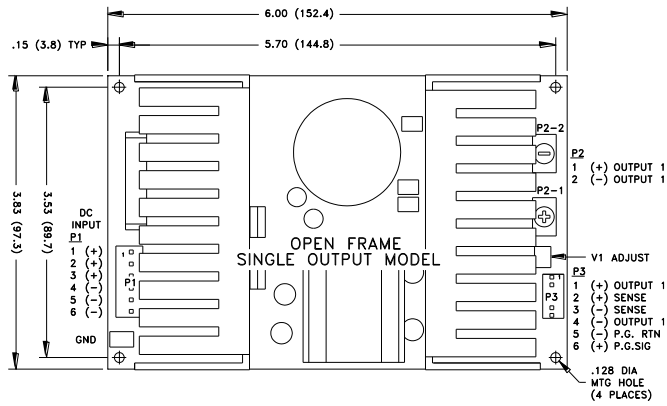
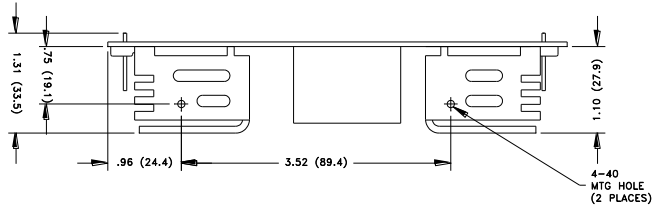

ALL DIMENSIONS IN INCHES (mm)

APPLICATIONS INFORMATION

- Each output can deliver its rated current but Total Output Power must not exceed 150W as determined by the cooling method.
- Generally, adequate cooling is provided when semiconductor case temperatures do not exceed 70°C rise and transformer temperature does not exceed 60°C rise at any specified ambient temperature.
- Sufficient area must be provided around power supply to allow natural movement of air to develop in convection-cooled applications.
- This product is intended for use as a professionally-installed component within information technology, industrial, and medical equipment and is not intended for stand-alone operation.
- A minimum load of 10% is required on Output 1 to ensure proper regulation of remaining outputs.
- Peak-to-Peak Output Ripple and Noise is measured directly at the output terminals of the power supply, without the use of the probe ground lead or retractable tip (tip-and-barrel method), 20 MHz bandwidth.
- This product was type-tested and safety-certified using the dielectric strength test voltages listed in Table 6 of IEC 60601-1:2005. In consideration of Clause 8.8.3, care must be taken to insure that the voltage applied to a reinforced insulation does not overstress different types and levels of insulation. Primary and secondary-to-ground capacitors may need to be disconnected prior to performing a dielectric strength test on the power supply or the end product. It is highly recommended that the DC test voltages listed in DVB.1, Annex DVB of UL 60601-1 1st Edition are not exceeded during a production-line dielectric strength test of the assembled end product. Please consult factory for further information.
- This power supply has been safety-approved and final-tested using a DC dielectric strength test. Please consult factory before performing an AC dielectric strength test.
- Remote-Sense terminals may be used to compensate for cable losses up to 250mV. The use of a twisted pair, decoupling capacitors and an appropriately-rated low-impedance capacitor connected across the load will increase noise immunity.
- Maximum screw penetration into bottom chassis mounting holes is 0.100 inches. Maximum screw penetration into side chassis mounting holes is 0.250 inches.
- Power Good feature provides a logic-high signal from an open collector transistor when DC input reaches minimum operating voltage.
- 300LFM minimum of airflow must be maintained one inch above all points of top-side components or cover when forced-air cooling is required.
- Total Power must not exceed 100W with convection cooling on open-frame models except where noted.
- Total Power must not exceed 150W with 300LFM forced-air cooling on open-frame models.
- Total Power must not exceed 85W with convection cooling and Chassis/Cover option.
- Total Power must not exceed 150W with 300LFM forced-air cooling and Chassis/Cover option.
- Rated 12A maximum with convection cooling.
- Rated 20A maximum with convection cooling.
- Total current from Outputs 3 & 4 must not exceed 3A with convection cooling.
- Total current from Outputs 1 & 2 must not exceed 15A with convection cooling.

CONNECTOR SPECIFICATIONS

P1	DC Input	0.156 friction lock header mates with Molex 09-50-3061 or equivalent crimp terminal housing with Molex 2478 or equivalent crimp terminal.
P2	DC Output (Single)	6-32 screw down terminal mates with #6 ring tongue terminal. (10 in-lb max)
P2	DC Output (Multiple)	0.156 friction lock header mates with Molex 09-50-3141 or equivalent crimp terminal housing with Molex 2478 or equivalent crimp terminal.
G	Ground	0.187 quick disconnect terminal.
P3	P.G./Sense (Single)	0.100 breakaway header mates with Molex 50-57-9006 or equivalent crimp terminal housing with Molex type 71851 or equivalent crimp terminal.
P3	P.G./Sense (Multiple)	0.100 breakaway header mates with Molex 22-55-2061 or equivalent crimp terminal housing with Molex type 70058 or equivalent crimp terminal.

REV. V 10/06/2022