



# EV2759-Q-01A

## 36V Switching Charger with Power Path Management for 1-Cell to 6-Cell Batteries Evaluation Board

### DESCRIPTION

The EV2759-Q-01A is an evaluation board for the MP2759, a highly integrated switching charger designed for portable devices with 1-cell to 6-cell series Li-ion or Li-polymer battery packs. It can achieve up to 3A of charge current, and supports a variety of battery chemistry types with different full battery voltages.

The MP2759 can operate from a maximum 36V DC input voltage. When an input power supply is present, the MP2759 charges the battery with four phases: trickle charge, pre-charge, constant current (CC) charge, or constant voltage (CV) charge.

To guarantee safe operation, the MP2759 has robust protection functions, such as battery over-voltage protection (OVP), battery temperature sensing and protection, thermal shutdown, and a charging safety timer.

### ELECTRICAL SPECIFICATIONS

Parameter	Symbol	Value	Units
Input voltage	$V_{IN}$	10 to 36	V
Input current	$I_{IN}$	Up to 3	A
Battery charge regulation voltage	$V_{BATT\_REG}$	3.6 to 4.4 (Adjustable)	V
Fast charge current	$I_{CC}$	Up to 3	A

### FEATURES

- Up to 36V Operation Input Voltage
- Up to 3A Charge Current
- 1-Cell to 6-Cell Series with 3.6V, 4.0V, 4.1V, 4.15V, 4.2V, 4.35V, or 4.4V Battery Regulation Voltage for Each Cell
- Input Current Limit Regulation
- Minimum Input Voltage Regulation
- Support OR Selection Power Path Management
- 0.5% Battery Regulation Voltage Accuracy
- Charge Operation Indicator
- Input Status Indicator
- Battery Over-Voltage Protection (OVP)
- Charging Safety Timer
- Battery Thermal Monitoring and Protection with JEITA Profile

### APPLICATIONS

- Industrial Medical Equipment
- Power Tools
- Robot and Portable Vacuum Cleaners
- Wireless Speakers

All MPS parts are lead-free, halogen-free, and adhere to the RoHS directive. For MPS green status, please visit the MPS website under Quality Assurance. "MPS", the MPS logo, and "Simple, Easy Solutions" are trademarks of Monolithic Power Systems, Inc. or its subsidiaries.

## EV2759-Q-01A EVALUATION BOARD

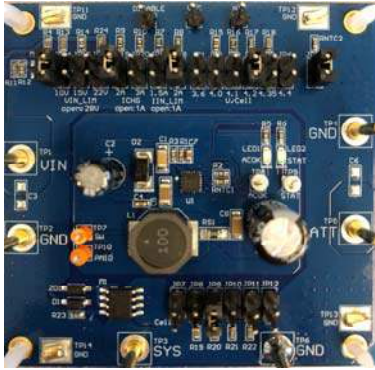

(LxWxH) 6.35cmx6.35cmx1.3cm

Board Number	MPS IC Number
EV2759-Q-01A	MP2759GQ-0000

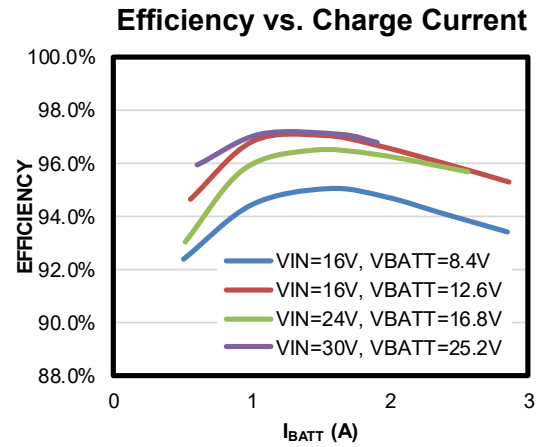

## QUICK START GUIDE

This board is designed for the MP2759, a highly integrated switching charger for 1-cell to 6-cell Li-ion/Li-Polymer batteries that are connected in series. This board's layout accommodates most commonly used capacitors. Table 1 lists the connectors.

**Table 1: Connectors**

Connectors	Description
TP1/VIN	Connect to the input source's positive terminal.
TP2/GND	Connect to the input source's negative terminal.
TP5/BATT	Connect to the battery pack's positive terminal.
TP4/GND	Connect to the battery pack's negative terminal.
TP3/SYS	Connect to the system load's positive terminal.
TP6/GND	Connect to the system load's negative terminal.
TP7/SW	Test point for the switching node.
TP10/PMID	Test point for PMID.
DISABLE, VCC, NTC, TP8/ACOK, TP9/STAT	Test connection for related signals.
TP11, TP12, TP13, TP14 / GND	Test point for ground.

1. Connect the system load to the SYS and GND connectors. Ensure that the load's positive and negative terminals are not reverse-connected. Ensure that the maximum system load current does not exceed the input source capacity. If the system load can exceed the input source's output current limit, use a Schottky diode with appropriate current capacity to bypass the Q1 body diode.
2. Connect the battery pack to the BATT and GND connectors. Ensure that the battery's positive and negative terminals are not reverse-connected.
3. If using a battery emulator, preset the battery emulator to the correct voltage. Turn the emulator off, connect the emulator to BATT and GND, then turn the emulator's output on.
4. Preset the input power source to its correct voltage, then turn the power source off. Connect the power source to VIN and GND, then turn the power source on. The EVB should start charging.
5. Ensure that the NTC jumper has been connected to avoid triggering an NTC fault.
6. To modify the charging parameters, configure the EVB using the jumpers. Table 2 lists the adjustable parameters.

**Table 2: Adjustable Parameters**

Adjustable Parameter	Value	Units
Charge current	1, 2, or 3	A
Input current limit	1, 1.5, or 2	A
Cell numbers	1, 2, 3, 4, 5, or 6	N/A
Battery regulation voltage (each cell)	3.6, 4.0, 4.15, 4.2, 4.35, or 4.4	V
Minimum input voltage limit	10, 15, 22, or 28	V

Table 3 lists the jumper connections.

**Table 3: Jumpers**

Jumpers	Description	Configurations	Default
JP1, JP2, JP3, JP4, JP5, JP6	Selects the battery regulation voltage for each cell	3.6V, 4.0V, 4.15V, 4.2V, 4.35V, or 4.4V	4.2V
JP7, JP8, JP9, JP10, JP11, JP12	Select the battery cell number	1 cell, 2 cells, 3 cells, 4 cells, 5 cells, or 6 cells	3 cells
JP13	NTC divider	Connect to NTC pin (pull up to VCC) or voltage divider	NTC divider
JP14, JP15, JP16	Selects the minimum input voltage limit	10V, 15V, 22V, or 28V	10V
JP17, JP18	Selects the input current limit	1A, 1.5A, or 2A	2A
JP19, JP20	Select the constant current charge current	1A, 2A, or 3A	2A

This board can work safely under the applications where  $V_{IN} < 20V$ . Table 4 lists the recommended components for applications exceeding 20V.

**Table 4: Component Selections**

Pin	Condition	Recommendations
IN	$\leq 20V$ input	Add a $1\mu F/50V$ ceramic capacitor to the IN pin for adapter applications. Use a minimum $47\mu F$ capacitor for solar applications.
	$> 20V$ input	Add a $47\mu F/50V$ electrolytic capacitor to the IN pin. Also add a TVS diode if the IN voltage exceeds the pin's maximum voltage rating during the $V_{IN}$ hot-insertion test
BATT	1-cell, 2-cell, 3-cell, or 4-cell	Add a $10\mu F/50V$ ceramic capacitor to the BATT pin.
	5-cell or 6-cell	Add a TVS diode or $\geq 47\mu F$ electrolytic capacitor to the BATT pin.
PMID	-	Add a $2.2\mu F/50V$ ceramic capacitor (1206 size preferred) to the PMID pin. Add a TVS diode if the PMID voltage exceeds the pin's maximum voltage rating during the $V_{BATT}$ hot-insertion test.

# EVALUATION BOARD SCHEMATIC

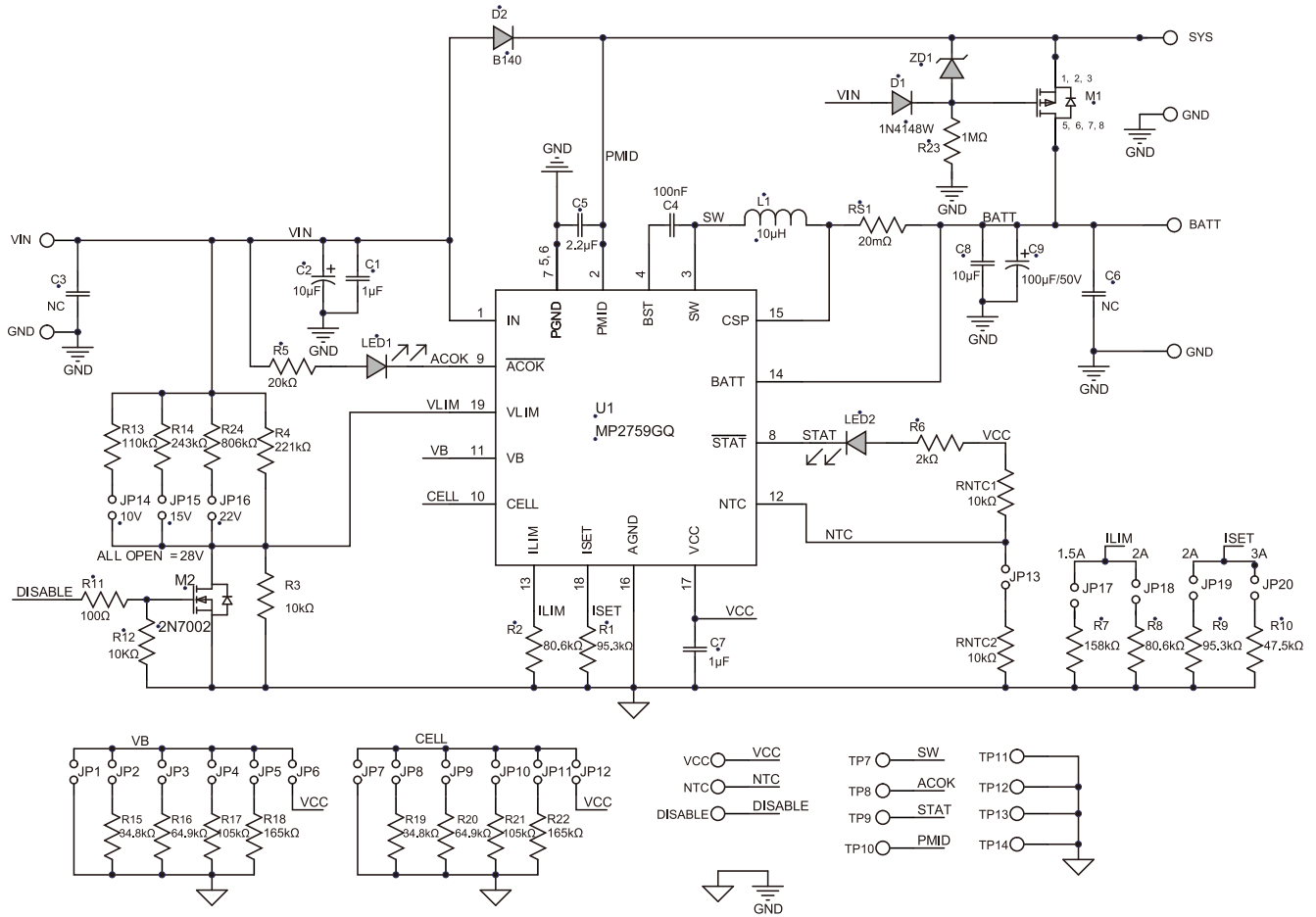

**Figure 1: Evaluation Board Schematic** (1) (2) (3) (4) (5)

**Notes:**

- 1) The EV2759-Q-01A can work safely in applications where  $V_{IN} < 20V$ .
- 2) For applications those exceed 20V, place a  $\geq 47\mu F$  electrolytic capacitor between VIN and GND. Also add a Schottky diode with higher current capacity (e.g. B240A) between VIN and PMID. Use a TVS diode to clamp the VIN voltage if its voltage spike reaches 45V.
- 3) Consider the voltage spike on PMID during battery insertion. Use an extra TVS diode to clamp the PMID voltage if its voltage spike reaches 45V.
- 4) For additional component selection information, refer to the MP2759 datasheet.
- 5) The inductor on this evaluation board can only be used in applications where  $f_{sw} = 700kHz$  or  $I_{CC} < 2.5A$ . For applications where  $f_{sw} = 450kHz$  or  $I_{CC} > 2.5A$ , select an inductor with higher inductance or higher saturation current.

**EV2759-Q-01A BILL OF MATERIALS**

Qty	Ref	Value	Description	Package	Manufacturer	Manufacturer P/N
1	C1	1 $\mu$ F	Ceramic capacitor, 50V, X7R	1206	Murata	GRM31MR71H105KA88L
1	C2	10 $\mu$ F	Electrolytic capacitor, 50V	DIP	Jianghai	CD287-50V10
1	C4	100nF	Ceramic capacitor, 50V, X7R	0603	Murata	GRM188R71H104KA93D
1	C5	2.2 $\mu$ F	Ceramic capacitor, 50V, X7R,	1206	Murata	GRM31CR71H225KA88L
1	C7	1 $\mu$ F	Ceramic capacitor, 25V, X7R	0603	Murata	GRM188R71E105KA12D
1	C8	10 $\mu$ F	Ceramic capacitor, 50V, X5R	1206	Murata	GRM31CR61H106KA12L
1	C9	100 $\mu$ F	Electrolytic capacitor, 50V, 100 $\mu$ F	DIP	Rubycon	50YXF100MEFC
1	L1	10 $\mu$ H	Inductor, 10 $\mu$ H, 35m $\Omega$ , 4A	SMD	Würth	744066100
1	RS1	20m $\Omega$	Film resistor, 1%	0805	Yageo	RL0805FR-070R02L
2	R1, R9	95.3k $\Omega$	Film resistor, 1%	0603	Yageo	RC0603FR-0795K3L
2	R2, R8	80.6k $\Omega$	Film resistor, 1%	0603	Yageo	RC0603FR-0780K6L
3	R3, RNTC1, RNTC2	10k $\Omega$	Film resistor, 1%	0603	Yageo	RC0603FR-0710KL
1	R4	221k $\Omega$	Film resistor, 1%	0603	Yageo	RC0603FR-07221KL
1	R5	20k $\Omega$	Film resistor, 5%	0603	Yageo	CR03T03705NJ20K
1	R6	2k $\Omega$	Film resistor, 1%	0603	Yageo	RC0603FR-072KL
1	R7	158k $\Omega$	Film resistor, 1%	0603	Yageo	RC0603FR-07158KL
1	R10	47.5k $\Omega$	Film resistor, 1%	0603	Yageo	RC0603FR-0747K5L
1	R11	100 $\Omega$	Film resistor, 1%	0603	Yageo	RC0603FR-07100RL
1	R12	10k $\Omega$	Film resistor, 5%	0603	Yageo	RC0603JR-0710K
1	R13	110k $\Omega$	Film resistor, 1%	0603	Yageo	RC0603FR-07110KL
1	R14	243k $\Omega$	Film resistor, 1%	0603	Yageo	RC0603FR-07243KL
2	R15, R19	34.8k $\Omega$	Film resistor, 1%	0603	Yageo	RC0603FR-0734K8L
2	R16, R20	64.9k $\Omega$	Film resistor, 1%	0603	Yageo	RC0603FR-0764K9L
2	R17, R21	105k $\Omega$	Film resistor, 1%	0603	Yageo	RC0603FR-07105KL
2	R18, R22	165k $\Omega$	Film resistor, 1%	0603	Yageo	RC0603FR-07165KL
1	R23	1M $\Omega$	Film resistor, 5%	0603	Yageo	RC0603JR-071ML
1	R24	806k $\Omega$	Film resistor, 1%	0603	Yageo	RC0603FR-07806KL
1	LED1	Red	LED red	0805	Bright LED	F3D02R-4A
1	LED2	Green	LED green	0805	Bright LED	F3D02HG-1A
1	U1	MP2759	Switching charger	QFN-19 (3mmx3mm)	MPS	MP2759GQ-0000
1	M1	AM4417 P	P-channel MOSFET, 60V, 23m $\Omega$	SOIC-8	Analog Power	AM4417P
1	M2	2N7002 MTF	N-channel MOSFET, 60V	SOT-23	Fairchild	2N7002MTF

**EV2759-Q-01A BILL OF MATERIALS (continued)**

Qty	Ref	Value	Description	Package	Manufacturer	Manufacturer P/N
1	D1	1N4148W	Diode, 75V, 0.15A	SOD-123	Diodes	1N4148W
1	D2	B140	Schottky diode, 40V, 1A	SMA		B140
1	ZD1	11V	Zener diode, 11V, 5mA/500mW	SOD-123	Diodes	BZT52C11

## EVB TEST RESULTS

Performance curves and waveforms are tested on the evaluation board.  $L = 10\mu\text{H}/35\text{m}\Omega$ ,  $C_{\text{BATT}} = 10\mu\text{F}$ ,  $R_{\text{SNS}} = 20\text{m}\Omega$ ,  $T_A = 25^\circ\text{C}$ , unless otherwise noted.

### Battery Charge Curve

$V_{\text{IN}} = 24\text{V}$ , 3-cell,  $V_{\text{BATT\_REG}} = 4.2\text{V}$ ,  $I_{\text{CC}} = 3\text{A}$ ,  $I_{\text{IN\_LIM}} = 2\text{A}$

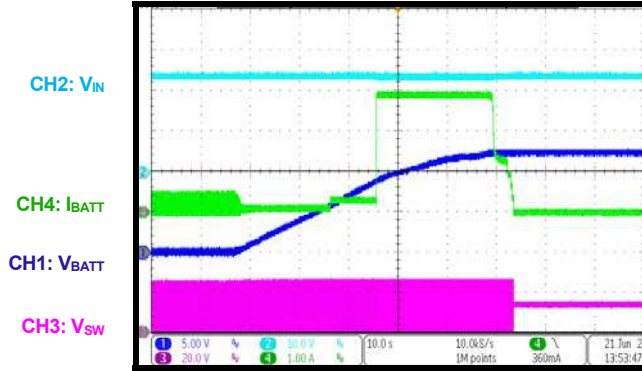

### Steady State

$V_{\text{IN}} = 24\text{V}$ , 4-cell,  $V_{\text{BATT}} = 7\text{V}$ ,  $I_{\text{CC}} = 3\text{A}$ ,  $I_{\text{IN\_LIM}} = 2\text{A}$ , trickle charge mode

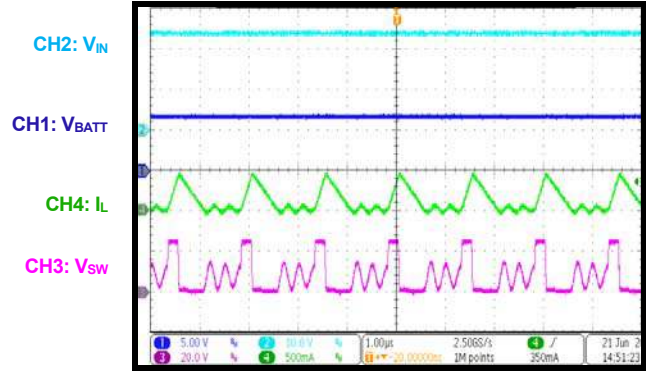

### Steady State

$V_{\text{IN}} = 24\text{V}$ , 4-cell,  $V_{\text{BATT}} = 10\text{V}$ ,  $I_{\text{CC}} = 3\text{A}$ ,  $I_{\text{IN\_LIM}} = 2\text{A}$ , pre-charge mode

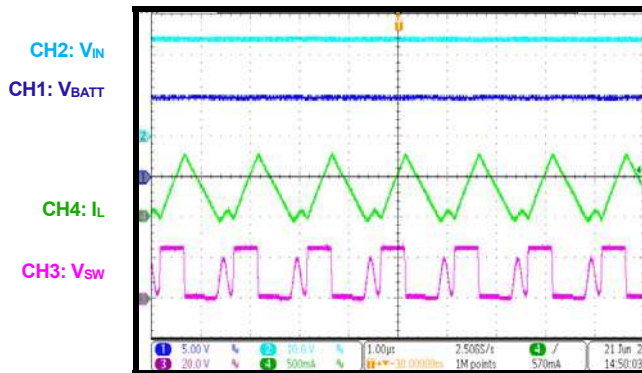

### Steady State

$V_{\text{IN}} = 24\text{V}$ , 4-cell,  $V_{\text{BATT}} = 12\text{V}$ ,  $I_{\text{CC}} = 3\text{A}$ ,  $I_{\text{IN\_LIM}} = 2\text{A}$ , constant current charge mode

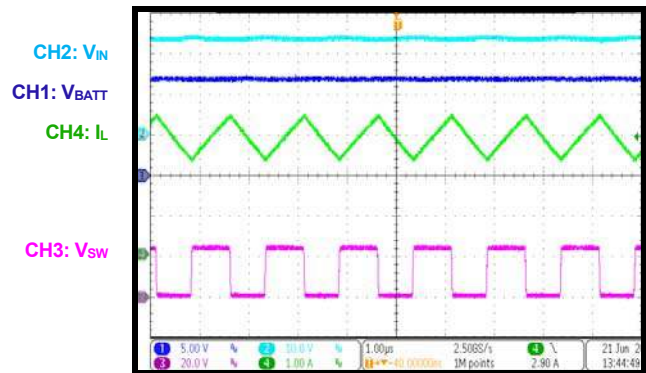

### Steady State

$V_{\text{IN}} = 24\text{V}$ , 4-cell,  $V_{\text{BATT}} = 16.8\text{V}$ ,  $I_{\text{CC}} = 3\text{A}$ ,  $I_{\text{IN\_LIM}} = 2\text{A}$ , constant voltage charge mode

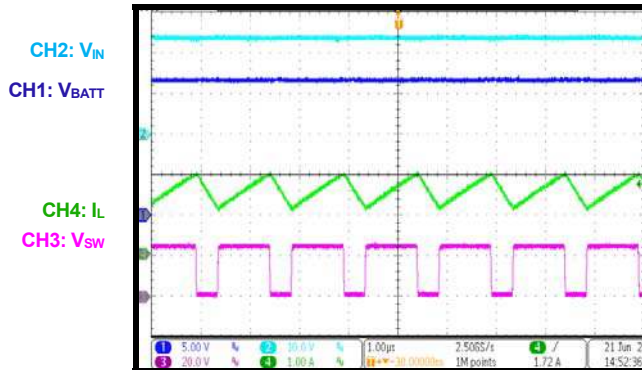

### Start-Up

$V_{\text{IN}} = 18\text{V}$ , 2-cell,  $V_{\text{BATT}} = 8\text{V}$ ,  $I_{\text{CC}} = 2\text{A}$ ,  $I_{\text{IN\_LIM}} = 2\text{A}$ , constant current charge mode

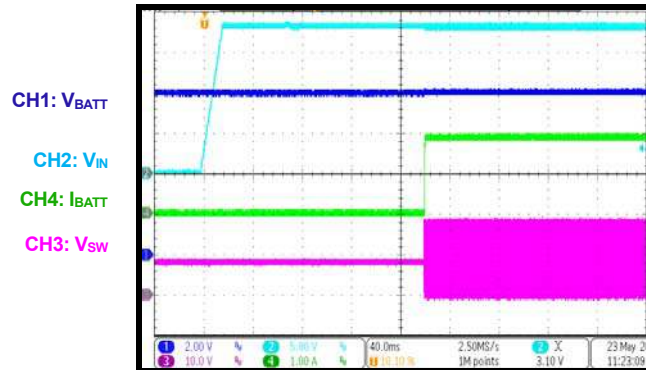



## EVB TEST RESULTS

Performance curves and waveforms are tested on the evaluation board.  $L = 10\mu\text{H}/35\text{m}\Omega$ ,  $C_{\text{BATT}} = 10\mu\text{F}$ ,  $R_{\text{SNS}} = 20\text{m}\Omega$ ,  $T_A = 25^\circ\text{C}$ , unless otherwise noted.

### Shutdown

$V_{\text{IN}} = 18\text{V}$ , 2-cell,  $V_{\text{BATT}} = 8\text{V}$ ,  $I_{\text{CC}} = 2\text{A}$ ,  
 $I_{\text{IN\_LIM}} = 2\text{A}$ , constant current charge mode

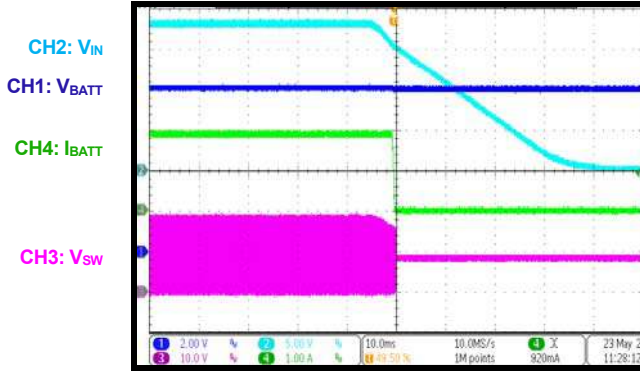

### Start-Up

Power path operation,  $V_{\text{IN}} = 18\text{V}$ , 2-cell,  
 $V_{\text{BATT}} = 8\text{V}$ ,  $I_{\text{CC}} = 2\text{A}$ ,  $I_{\text{IN\_LIM}} = 1\text{A}$ ,  $I_{\text{SYS}} = 0.9\text{A}$

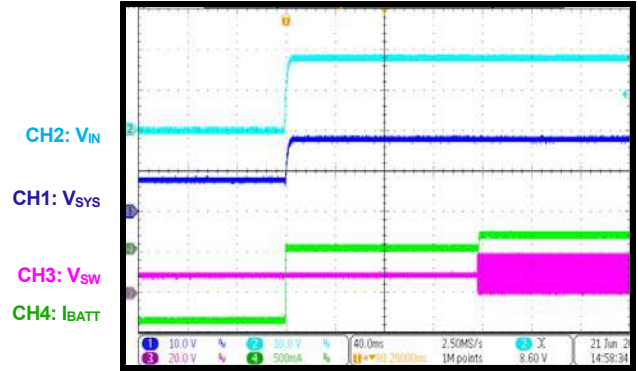

### Shutdown

Power path operation,  $V_{\text{IN}} = 18\text{V}$ , 2-cell,  
 $V_{\text{BATT}} = 8\text{V}$ ,  $I_{\text{CC}} = 2\text{A}$ ,  $I_{\text{IN\_LIM}} = 1\text{A}$ ,  $I_{\text{SYS}} = 0.9\text{A}$

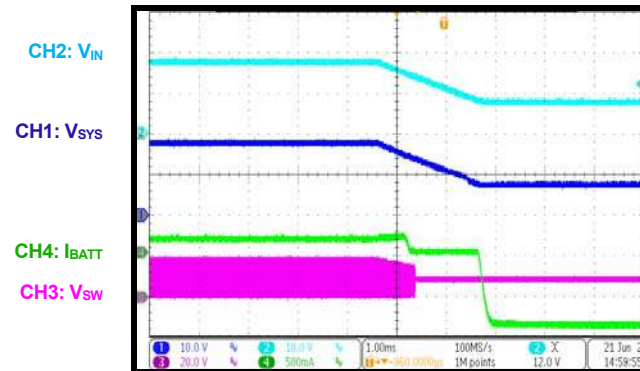

### $I_{\text{IN\_LIM}}$ Loop Control

$V_{\text{IN}} = 24\text{V}$ , 3-cell,  $V_{\text{BATT}} = 10\text{V}$ ,  $I_{\text{CC}} = 3\text{A}$ ,  
 $I_{\text{IN\_LIM}} = 1\text{A}$

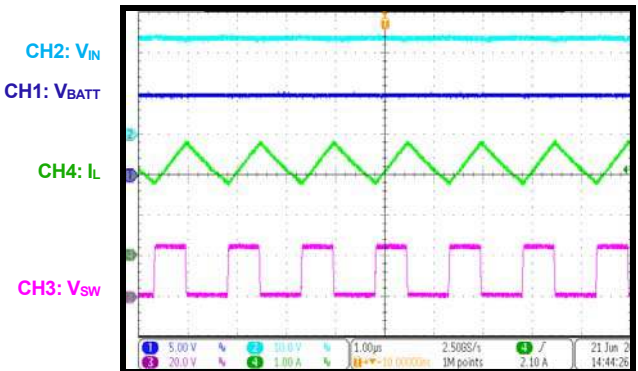

### $V_{\text{IN\_LIM}}$ Loop Control

$V_{\text{IN}} = 24\text{V}/1\text{A}$ , 3-cell,  $V_{\text{BATT}} = 10\text{V}$ ,  $I_{\text{CC}} = 3\text{A}$ ,  
 $I_{\text{IN\_LIM}} = 2\text{A}$ ,  $V_{\text{IN\_LIM}} = 15\text{V}$

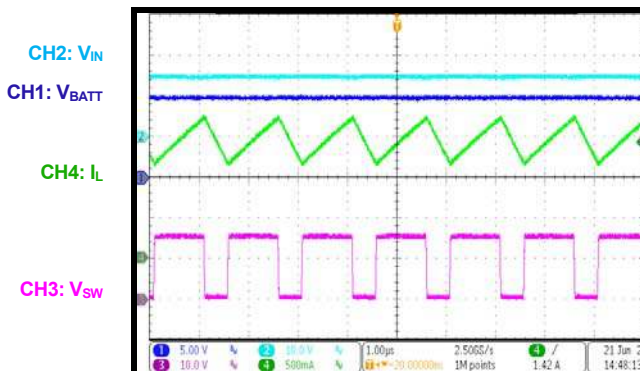

### $V_{\text{LIM}}$ On/Off

$V_{\text{IN}} = 18\text{V}$ , 2-cell,  $V_{\text{BATT}} = 8\text{V}$ ,  $I_{\text{CC}} = 2\text{A}$ ,  
 $I_{\text{IN\_LIM}} = 2\text{A}$ ,  $\text{DISABLE} = 5\text{V}/1\text{Hz}$

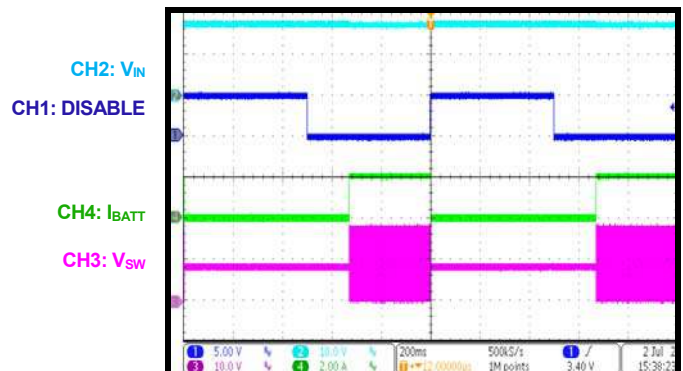

## PCB LAYOUT

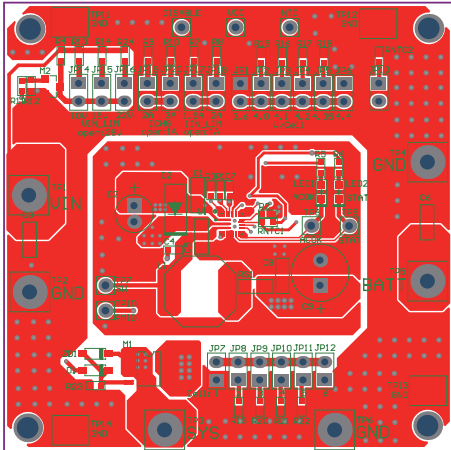

Figure 2: Top Layer

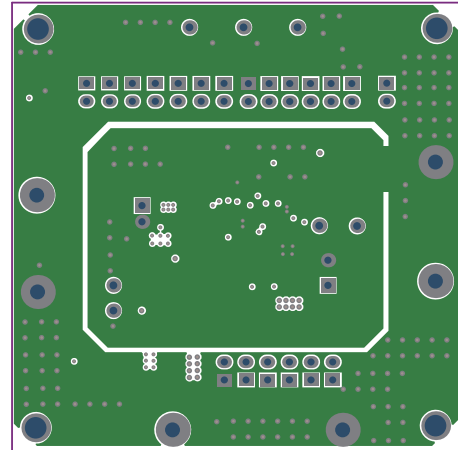

Figure 3: Middle Layer 1

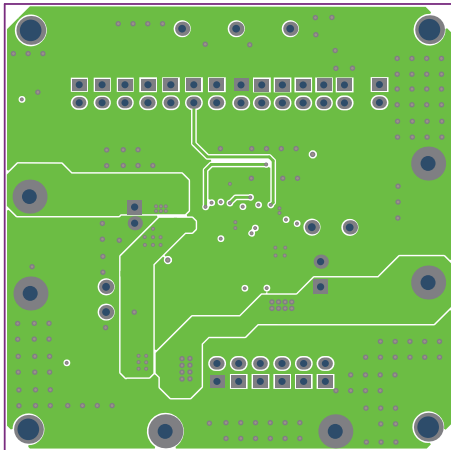

Figure 4: Middle Layer 2

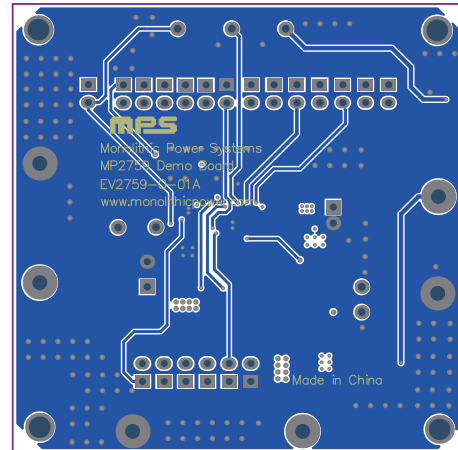

Figure 5: Bottom Layer

## Revision History

Revision #	Revision Date	Description	Pages Updated
1.0	12/7/2020	Initial Release	-

**Notice:** The information in this document is subject to change without notice. Please contact MPS for current specifications. Users should warrant and guarantee that third-party Intellectual Property rights are not infringed upon when integrating MPS products into any application. MPS will not assume any legal responsibility for any said applications.