



## STC6NF30V

N-channel 30V - 0.020Ω - 6A - TSSOP8  
2.5V-drive STripFET™ II Power MOSFET

### General features

Type	V <sub>DSS</sub>	R <sub>DS(on)</sub>	I <sub>D</sub>
STC6NF30V	30V	< 0.025 Ω (@ 4.5 V) < 0.030 Ω (@ 2.7 V)	6A

- Ultra low threshold gate drive (2.5V)
- Standard outline for easy automated surface mount assembly
- Double dice in common drain configuration

### Description

This Power MOSFET is the latest development of STMicroelectronics unique "Single Feature Size™" strip-based process. The resulting transistor shows extremely high packing density for low on-resistance.

### Applications

- Switching application

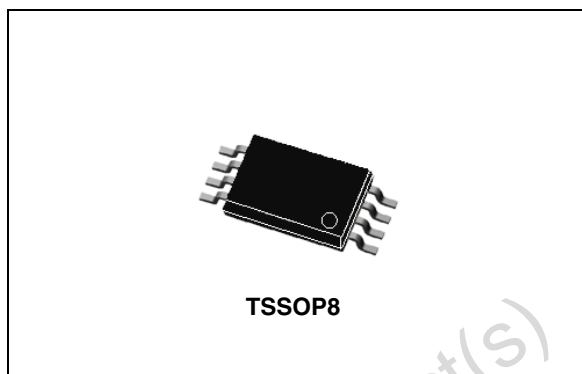

### Internal schematic diagram

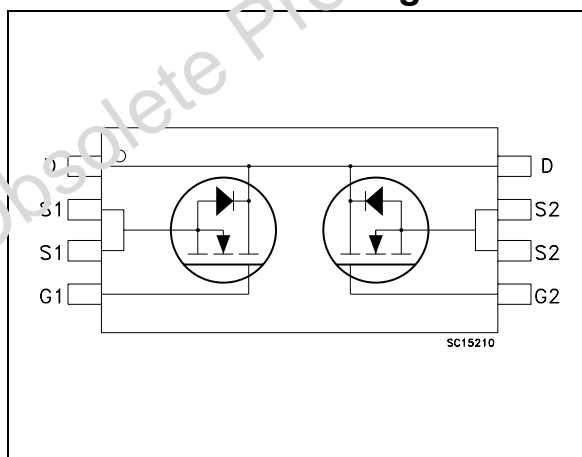

### Order code

Part number	Marking	Package	Packaging
STC6NF30V	C6NF30V	TSSOP8	Tape & reel

# Contents

<b>1</b>	<b>Electrical ratings</b> .....	<b>3</b>
<b>2</b>	<b>Electrical characteristics</b> .....	<b>4</b>
	2.1 Electrical characteristics (curves) .....	6
<b>3</b>	<b>Test circuit</b> .....	<b>9</b>
<b>4</b>	<b>Package mechanical data</b> .....	<b>10</b>
<b>5</b>	<b>Revision history</b> .....	<b>12</b>

Obsolete Product(s) - Obsolete Product(s)

# 1 Electrical ratings

**Table 1. Absolute maximum ratings**

Symbol	Parameter	Value	Unit
$V_{DS}$	Drain-source voltage ( $V_{GS} = 0$ )	30	V
$V_{DGR}$	Drain-gate voltage ( $R_{GS} = 20K\Omega$ )	20	V
$V_{GS}$	Gate-source voltage	$\pm 12$	V
$I_D$	Drain current (continuous) at $T_C = 25^\circ C$	6	A
$I_D$	Drain current (continuous) at $T_C = 100^\circ C$	3.8	A
$I_{DM}^{(1)}$	Drain current (pulsed)	24	A
$P_{TOT}$	Total dissipation at $T_C = 25^\circ C$	1.5	W
$T_{stg}$	Storage temperature	-55 to 150	$^\circ C$
$T_J$	Max. Operating Junction Temperature	-55 to 150	$^\circ C$

1. Pulse width limited by safe operating area

**Table 2. Thermal data**

Symbol	Parameter	Value	Unit
$R_{thJ-PBC}$	Thermal resistance junction-PBC Max	100 <sup>(1)</sup>	$^\circ C/W$
$R_{thJ-PBC}$	Thermal resistance junction-PBC Max	83.5 <sup>(2)</sup>	$^\circ C/W$

1. When Mounted on FR-4 board with 1 inch<sup>2</sup> pad, 2 oz. of Cu. and t = 10 sec.

2. When Mounted on minimum recommended footprint

## 2 Electrical characteristics

( $T_J = 25^\circ\text{C}$  unless otherwise specified)

**Table 3. On/off states**

Symbol	Parameter	Test conditions	Min.	Typ.	Max.	Unit
$V_{(BR)DSS}$	Drain-source breakdown voltage	$I_D = 250\mu\text{A}$ , $V_{GS} = 0$	30			V
$I_{DSS}$	Zero gate voltage drain current ( $V_{GS} = 0$ )	$V_{DS} = \text{Max rating}$ , $V_{DS} = \text{Max rating @ } 125^\circ\text{C}$			1 10	$\mu\text{A}$ $\mu\text{A}$
$I_{GSS}$	Gate body leakage current ( $V_{DS} = 0$ )	$V_{GS} = \pm 12\text{V}$			$\pm 100$	nA
$V_{GS(th)}$	Gate threshold voltage	$V_{DS} = V_{GS}$ , $I_D = 250\mu\text{A}$	0.6			V
$R_{DS(on)}$	Static drain-source on resistance	$V_{GS} = 4.5\text{V}$ , $I_D = 3\text{A}$ $V_{GS} = 2.5\text{V}$ , $I_D = 3\text{A}$		0.020 0.025	0.025 0.030	$\Omega$ $\Omega$

**Table 4. Dynamic**

Symbol	Parameter	Test conditions	Min.	Typ.	Max.	Unit
$g_{fs}^{(1)}$	Forward transconductance	$V_{DS} = 10\text{V}$ , $I_D = 6\text{A}$		18		S
$C_{iss}$	Input capacitance	$V_{DS} = 25\text{V}$ , $f = 1\text{ MHz}$ , $V_{GS} = 0$		800		pF
$C_{oss}$	Output capacitance			180		pF
$C_{rss}$	Reverse transfer capacitance			32		pF
$Q_g$	Total gate charge	$V_{DD} = 15\text{V}$ , $I_D = 6\text{A}$		6.8	9	nC
$Q_{gs}$	Gate-source charge	$V_{GS} = 2.5\text{V}$		2.0		nC
$Q_{gd}$	Gate-drain charge	<a href="#">Figure 16 on page 9</a>		3.4		nC

1. Pulsed: pulse duration=300 $\mu\text{s}$ , duty cycle 1.5%

**Table 5. Switching times**

Symbol	Parameter	Test conditions	Min.	Typ.	Max.	Unit	
$t_{d(on)}$	Turn-on delay time	$V_{DD} = 15\text{V}$ , $I_D = 3\text{A}$ , $R_G = 4.7\Omega$ , $V_{GS} = 2.5\text{V}$ <a href="#">Figure 14 on page 9</a>		20		ns	
$t_r$	Rise time			25		ns	
$t_{d(off)}$	Turn-off delay time				32		ns
$t_f$	Fall time				13		ns

**Table 6. Source drain diode**

Symbol	Parameter	Test conditions	Min.	Typ.	Max	Unit
$I_{SD}$	Source-drain current				6	A
$I_{SDM}^{(1)}$	Source-drain current (pulsed)				24	A
$V_{SD}^{(2)}$	Forward on voltage	$I_{SD} = 6A, V_{GS} = 0$			1.2	V
$t_{rr}$	Reverse recovery time	$I_{SD} = 6A,$ $di/dt = 100A/\mu s,$ $V_{DD} = 15V, T_J = 150^\circ C$ <i>Figure 16 on page 9</i>		25		ns
$Q_{rr}$	Reverse recovery charge			21		$\mu C$
$I_{RRM}$	Reverse recovery current			1.7		A

1. Pulse width limited by safe operating area
2. Pulsed: pulse duration=300 $\mu s$ , duty cycle 1.5%

Obsolete Product(s) - Obsolete Product(s)

## 2.1 Electrical characteristics (curves)

Figure 1. Safe operating area

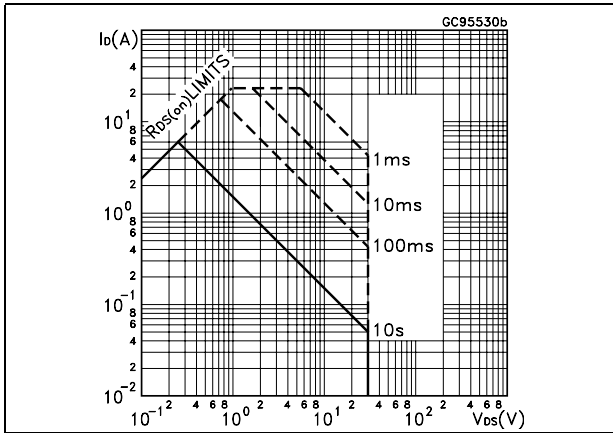

Figure 2. Thermal impedance

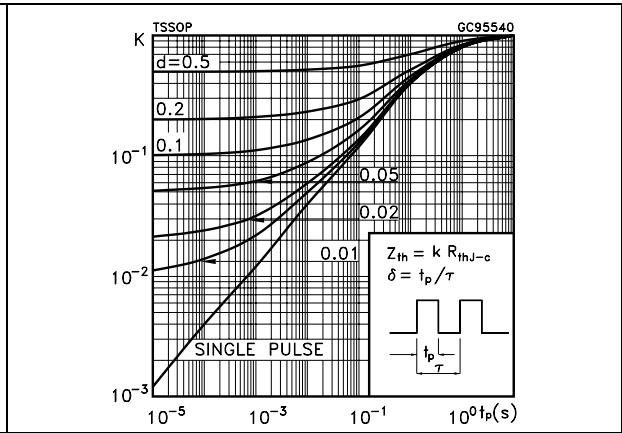

Figure 3. Output characteristics

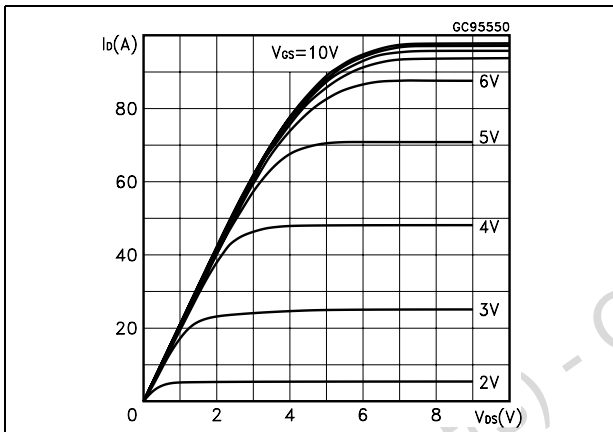

Figure 4. Transfer characteristics

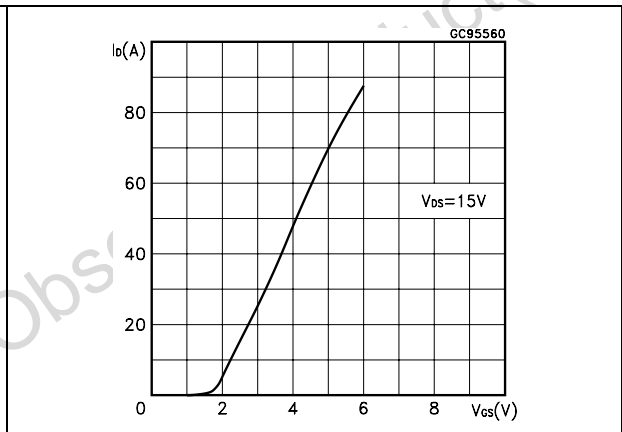

Figure 5. Transconductance

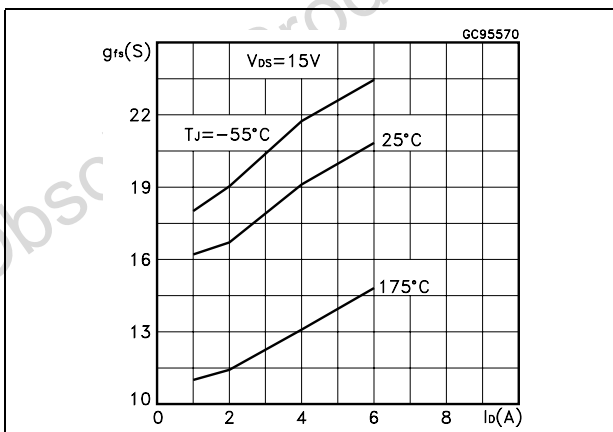

Figure 6. Static drain-source on resistance

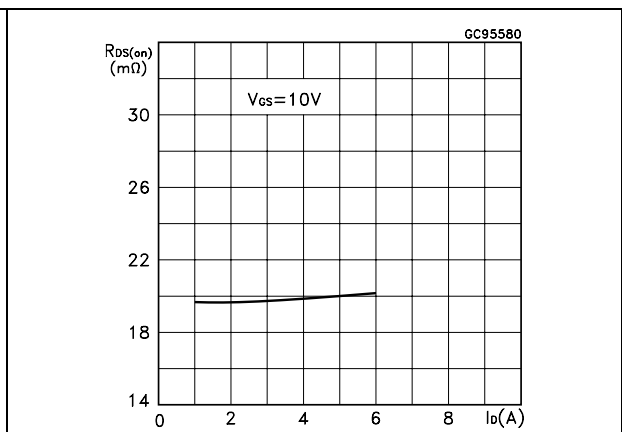

Figure 7. Gate charge vs. gate-source voltage Figure 8. Capacitance variations

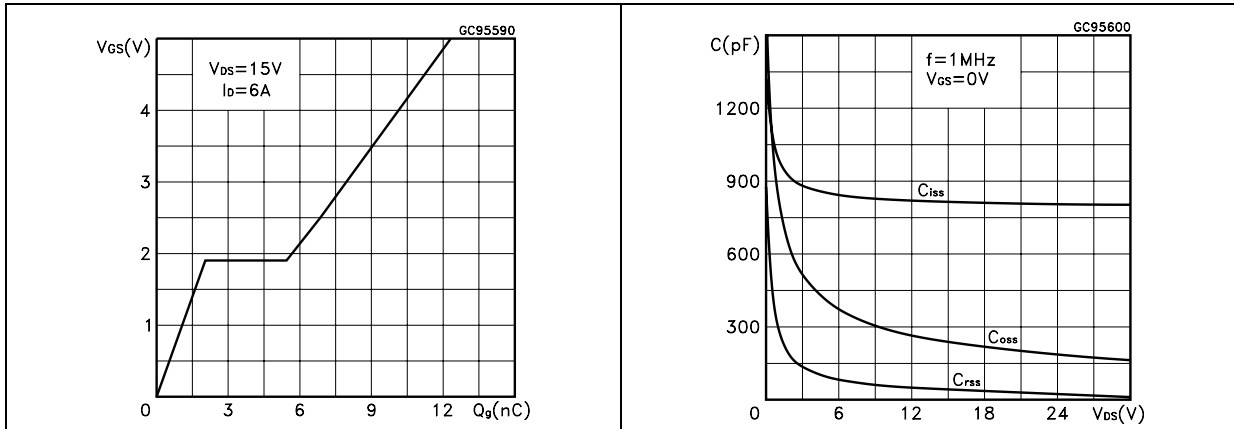

Figure 9. Normalized gate threshold voltage vs. temperature Figure 10. Normalized on resistance vs. temperature

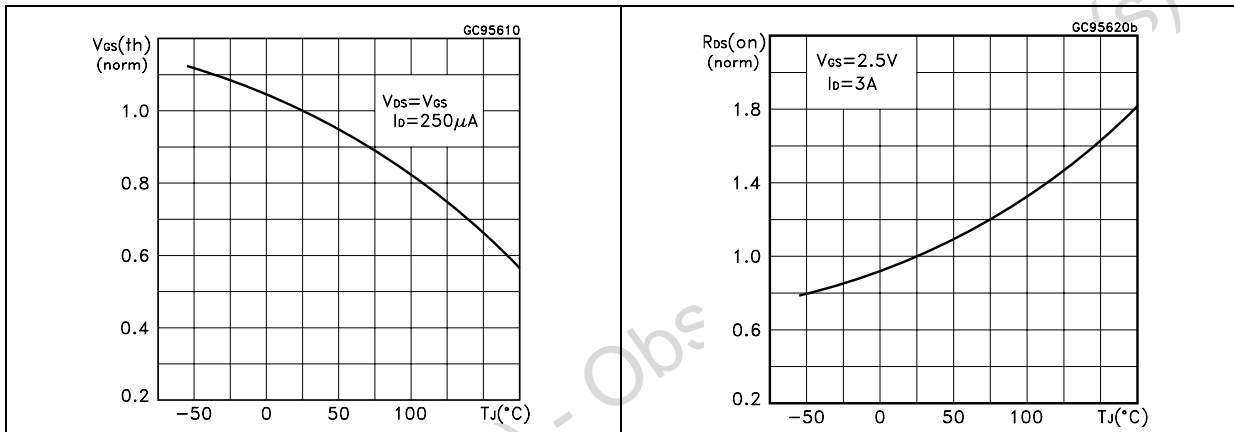

Figure 11. Source-drain diode forward characteristics Figure 12. Normalized breakdown voltage temperature

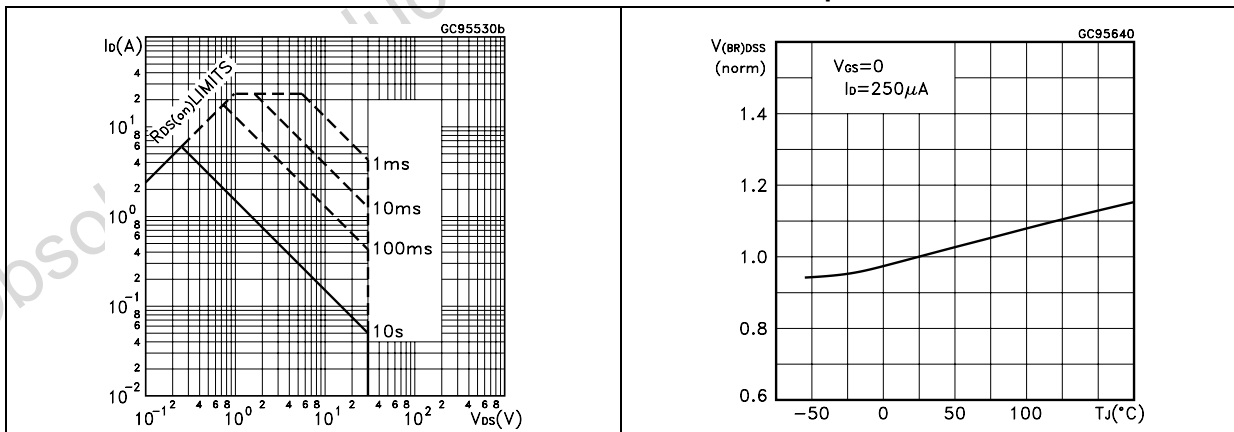
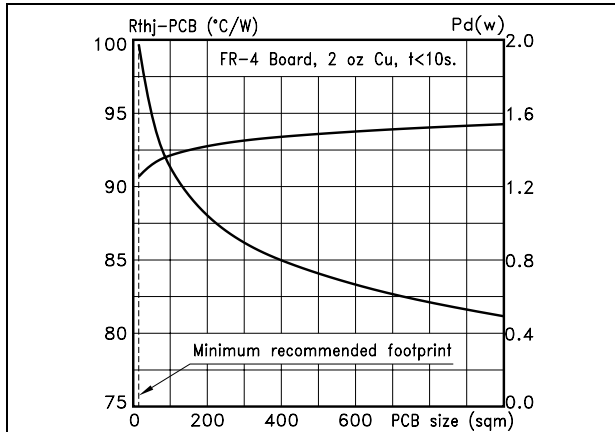

Figure 13. Thermal resistance and max power



Obsolete Product(s) - Obsolete Product(s)



### 3 Test circuit

Figure 14. Switching times test circuit for resistive load

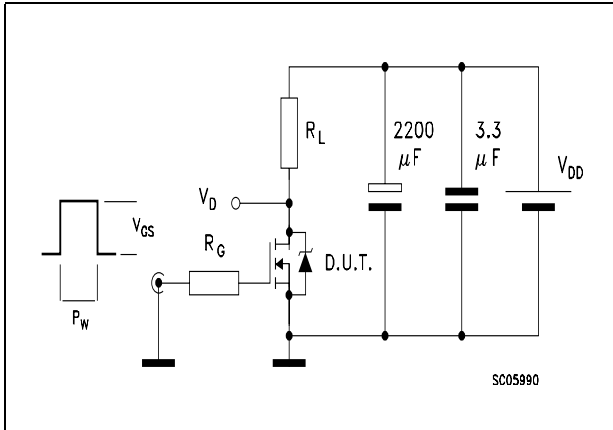

Figure 15. Gate charge test circuit

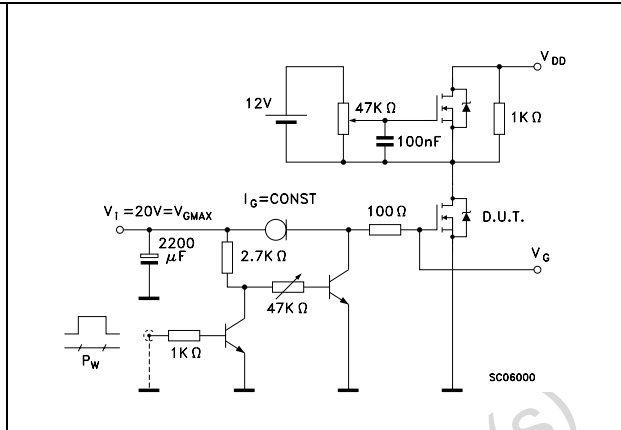
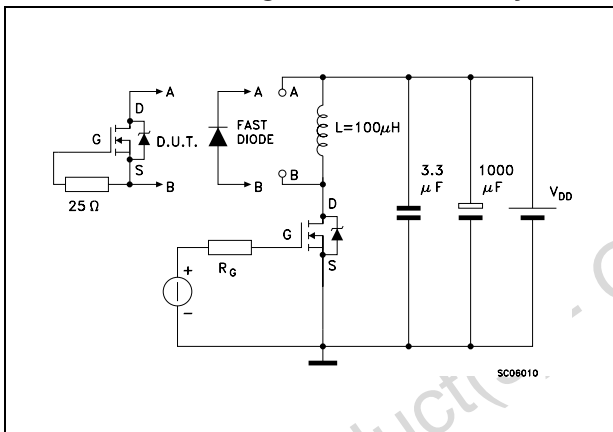

Figure 16. Test circuit for inductive load switching and diode recovery times



Obsolete Product(s)

## 4 Package mechanical data

In order to meet environmental requirements, ST offers these devices in ECOPACK® packages. These packages have a Lead-free second level interconnect. The category of second level interconnect is marked on the package and on the inner box label, in compliance with JEDEC Standard JESD97. The maximum ratings related to soldering conditions are also marked on the inner box label. ECOPACK is an ST trademark. ECOPACK specifications are available at: [www.st.com](http://www.st.com)

Obsolete Product(s) - Obsolete Product(s)

## TSSOP8 MECHANICAL DATA

DIM.	mm.			inch		
	MIN.	TYP.	MAX.	MIN.	TYP.	MAX.
A	1.05		1.20	0.041		0.047
A1	0.05		0.15	0.002		0.006
A2	0.80		1.05	0.032		0.041
b	0.19		0.30	0.008		0.012
c		0.127			0.005	
D	2.90		3.10	0.114		0.122
E	4.30		4.50	0.170		0.177
E1	6.20		6.60	0.240		0.260
E2	5.14		5.24	0.202		0.206
e		0.65			0.025	
L	0.45		0.75	0.018		0.030
L1	0.90		1.10	0.0355		0.0433
R	0.09			0.004		
R1	0.09			0.004		
$\theta 1$	0°		8°	0°		8°
$\theta 2$	12°					

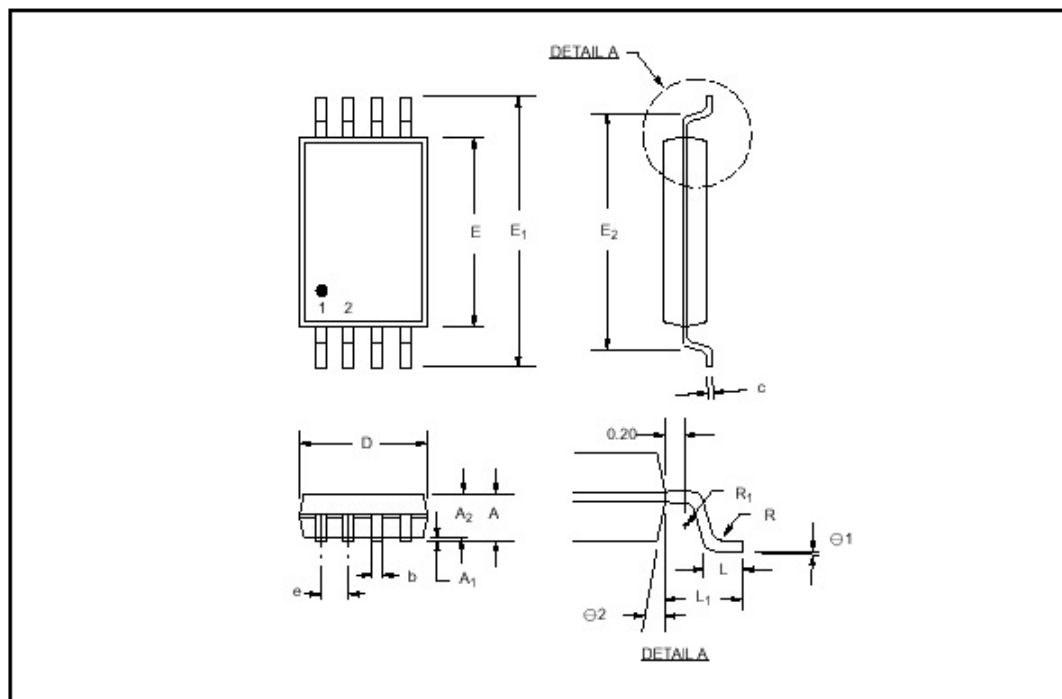

## 5 Revision history

**Table 7. Revision history**

<b>Date</b>	<b>Revision</b>	<b>Changes</b>
21-Jun-2004	2	Complete document
03-Aug-2006	3	The document has been reformatted, SOA updated
01-Feb-2007	4	Typo mistake on first page

Obsolete Product(s) - Obsolete Product(s)

**Please Read Carefully:**

Information in this document is provided solely in connection with ST products. STMicroelectronics NV and its subsidiaries ("ST") reserve the right to make changes, corrections, modifications or improvements, to this document, and the products and services described herein at any time, without notice.

All ST products are sold pursuant to ST's terms and conditions of sale.

Purchasers are solely responsible for the choice, selection and use of the ST products and services described herein, and ST assumes no liability whatsoever relating to the choice, selection or use of the ST products and services described herein.

No license, express or implied, by estoppel or otherwise, to any intellectual property rights is granted under this document. If any part of this document refers to any third party products or services it shall not be deemed a license grant by ST for the use of such third party products or services, or any intellectual property contained therein or considered as a warranty covering the use in any manner whatsoever of such third party products or services or any intellectual property contained therein.

**UNLESS OTHERWISE SET FORTH IN ST'S TERMS AND CONDITIONS OF SALE ST DISCLAIMS ANY EXPRESS OR IMPLIED WARRANTY WITH RESPECT TO THE USE AND/OR SALE OF ST PRODUCTS INCLUDING WITHOUT LIMITATION IMPLIED WARRANTIES OF MERCHANTABILITY, FITNESS FOR A PARTICULAR PURPOSE (AND THEIR EQUIVALENTS UNDER THE LAWS OF ANY JURISDICTION), OR INFRINGEMENT OF ANY PATENT, COPYRIGHT OR OTHER INTELLECTUAL PROPERTY RIGHT.**

**UNLESS EXPRESSLY APPROVED IN WRITING BY AN AUTHORIZED ST REPRESENTATIVE, ST PRODUCTS ARE NOT RECOMMENDED, AUTHORIZED OR WARRANTED FOR USE IN MILITARY, AIR CRAFT, SPACE, LIFE SAVING, OR LIFE SUSTAINING APPLICATIONS, NOR IN PRODUCTS OR SYSTEMS WHERE FAILURE OR MALFUNCTION MAY RESULT IN PERSONAL INJURY, DEATH, OR SEVERE PROPERTY OR ENVIRONMENTAL DAMAGE. ST PRODUCTS WHICH ARE NOT SPECIFIED AS "AUTOMOTIVE GRADE" MAY ONLY BE USED IN AUTOMOTIVE APPLICATIONS AT USER'S OWN RISK.**

Resale of ST products with provisions different from the statements and/or technical features set forth in this document shall immediately void any warranty granted by ST for the ST product or service described herein and shall not create or extend in any manner whatsoever, any liability of ST.

ST and the ST logo are trademarks or registered trademarks of ST in various countries.

Information in this document supersedes and replaces all information previously supplied.

The ST logo is a registered trademark of STMicroelectronics. All other names are the property of their respective owners.

© 2007 STMicroelectronics - All rights reserved

STMicroelectronics group of companies

Australia - Belgium - Brazil - Canada - China - Czech Republic - Finland - France - Germany - Hong Kong - India - Israel - Italy - Japan - Malaysia - Malta - Morocco - Singapore - Spain - Sweden - Switzerland - United Kingdom - United States of America

[www.st.com](http://www.st.com)