

**Power Inductor AKPx Series**

**Automotive  
AEC-Q200**

RoHS Compliant  
Halogen Free  
REACH Compliant



- Noise  
Suppression
- Shield
- Multilayer
- Ferrite
- General  
Signal line

**Part Numbering**

A	KPx	00	201610	1R0	M	00
Grade	Series Name	Control Code	Dimensions Code (mm)	Inductance (uH)	Tolerance	Internal Code
	KPB		1608DZ 1.6x0.8x0.8	R47 0.47	T ±30%	A2
	KPE		201210 2.0x1.25x1.0	1R0 1.0	M ±20%	A6
			201610 2.0x1.6x1.0			
			252010 2.5x2.0x1.0			

This specification applies to Multilayer Chip Inductors for Automotive Electronics based on AEC-Q200 except for Power train and Safety.

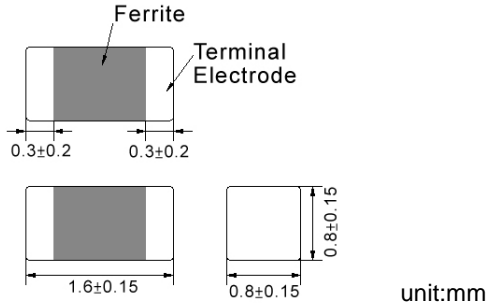
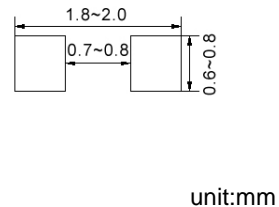
**AKPB001608DZ Type**
**■ Dimensions**

**■ Recommended Land Pattern**

**■ Electrical Characteristics**

Part No.	Inductance	Test Freq.	RDC	Isat	I <sub>rms</sub> (mA)Max.		Tolerance
	(uH)				( $\Omega$ ) $\pm 30\%$	(mA)Max.	
AKPB001608DZR47□A2	0.47	3MHz,200mV	0.15	400	1100	800	20,30
AKPB001608DZ1R0□A2	1.0	3MHz,200mV	0.20	200	950	700	20,30
AKPB001608DZ2R2□A2	2.2	3MHz,200mV	0.30	150	750	550	20,30

**Note: When ordering, please specify tolerance code. Tolerance: M= $\pm 20\%$  / T= $\pm 30\%$**

- Operating temperature range - 55°C ~ 125°C
- Isat for Inductance drop 30% from its value without current
- I<sub>rms</sub> for When applied current to the Products, temperature rise caused by self-generated heat shall be limited to 40 °C max
- As for the Rated current marked with \*1, Rated Current is depending on the operating temperature
- Measure Equipment :  
 L : Agilent HP4287A+16197A  
 RDC : HP 4338B, or equivalent

**AKPB001608DZ Type**

**Characteristics Graph**

**Inductance vs. Frequency Characteristics**

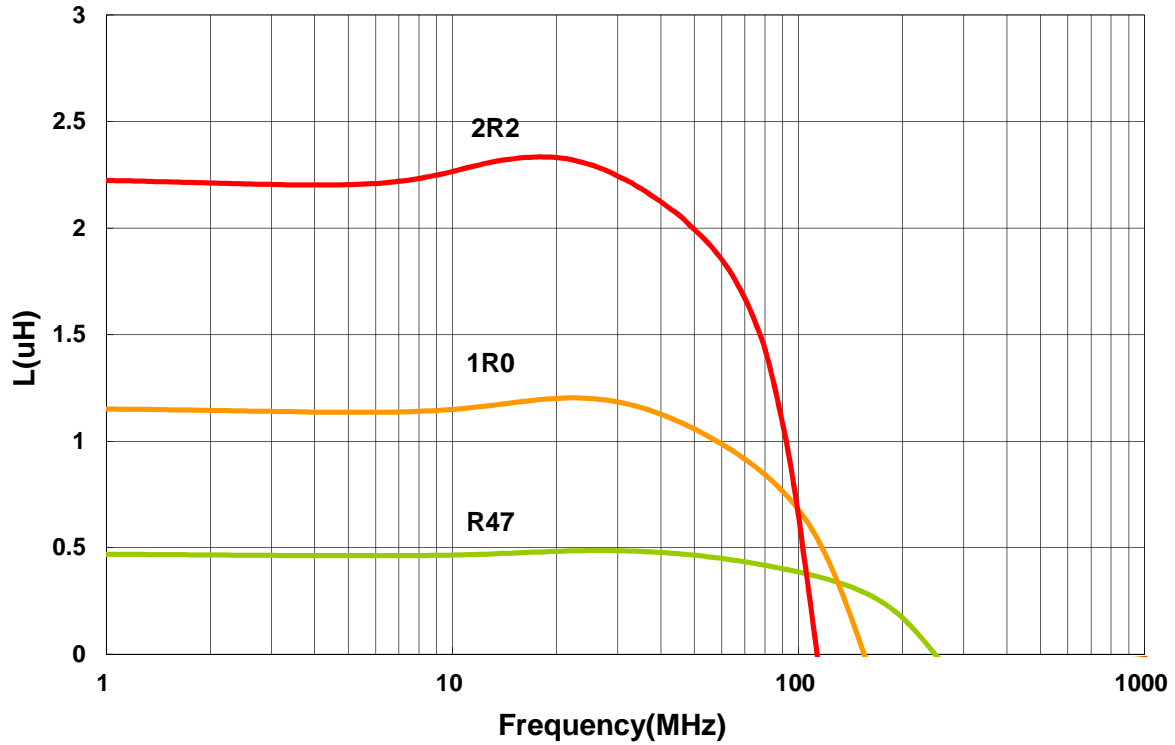

**Inductance vs. DC Current**

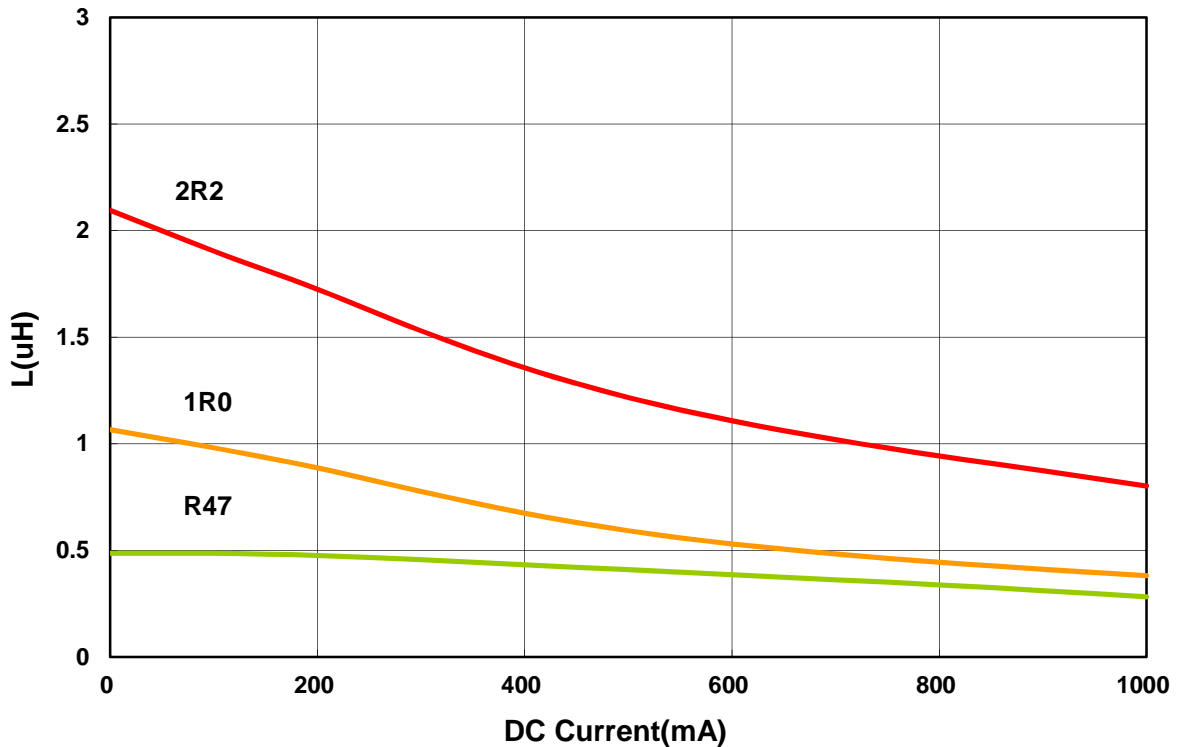

Please be sure to request approval specifications that provide further details of the products. Kindly note that the content of these specifications are subject to change or may be discontinued without prior notice. This product may not be designed/used in medical or high risk applications without Chilisin approval. Please contact our sales department before ordering.

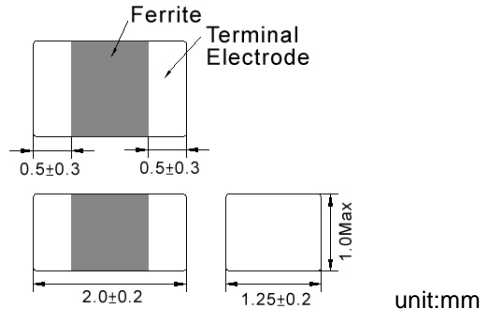
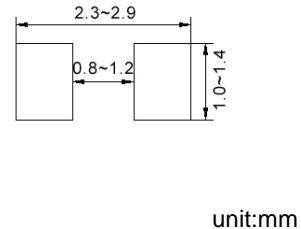
**AKPB00201210 Type**
**■ Dimensions**

**■ Recommended Land Pattern**

**■ Electrical Characteristics**

Part No.	Inductance	Test Freq.	RDC	Isat	Irms(mA)Max.		Tolerance
	(uH)				(Ω)±30%	(mA)Max.	
AKPB00201210R47□A2	0.47	3MHz,200mV	0.09	1100	1300	950	20,30
AKPB002012101R0□A2	1.0	3MHz,200mV	0.12	650	1200	900	20,30
AKPB002012101R5□A2	1.5	3MHz,200mV	0.15	450	1100	800	20,30
AKPB002012102R2□A2	2.2	3MHz,200mV	0.19	400	1100	800	20,30
AKPB002012103R3□A2	3.3	3MHz,200mV	0.24	300	800	600	20,30
AKPB002012104R7□A2	4.7	3MHz,200mV	0.26	200	700	500	20,30

**Note: When ordering, please specify tolerance code. Tolerance: M=±20% / T=±30%**

- Operating temperature range - 55°C ~ 125°C
- Isat for Inductance drop 30% from its value without current
- Irms for When applied current to the Products, temperature rise caused by self-generated heat shall be limited to 40 °C max
- As for the Rated current marked with \*1, Rated Current is depending on the operating temperature
- Measure Equipment :  
 L : Agilent HP4287A+16197A  
 RDC : HP 4338B, or equivalent

**AKPB00201210 Type**

**Characteristics Graph**

**Inductance vs. Frequency Characteristics**

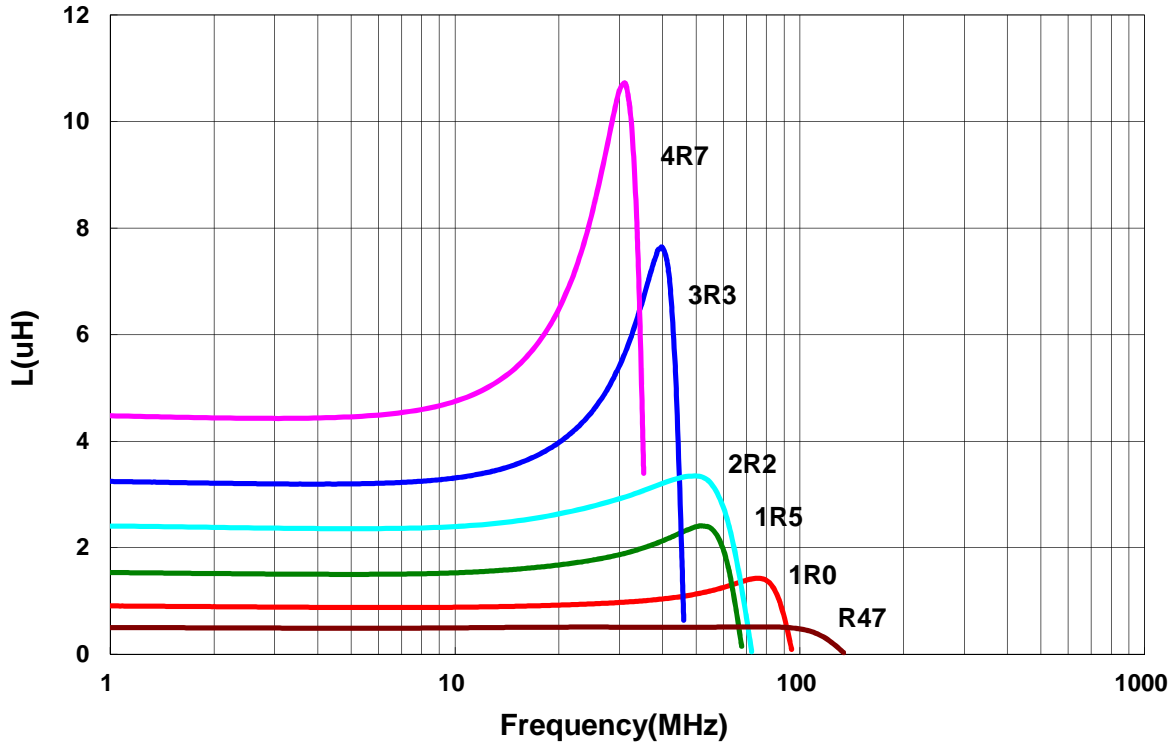

**Inductance vs. DC Current**

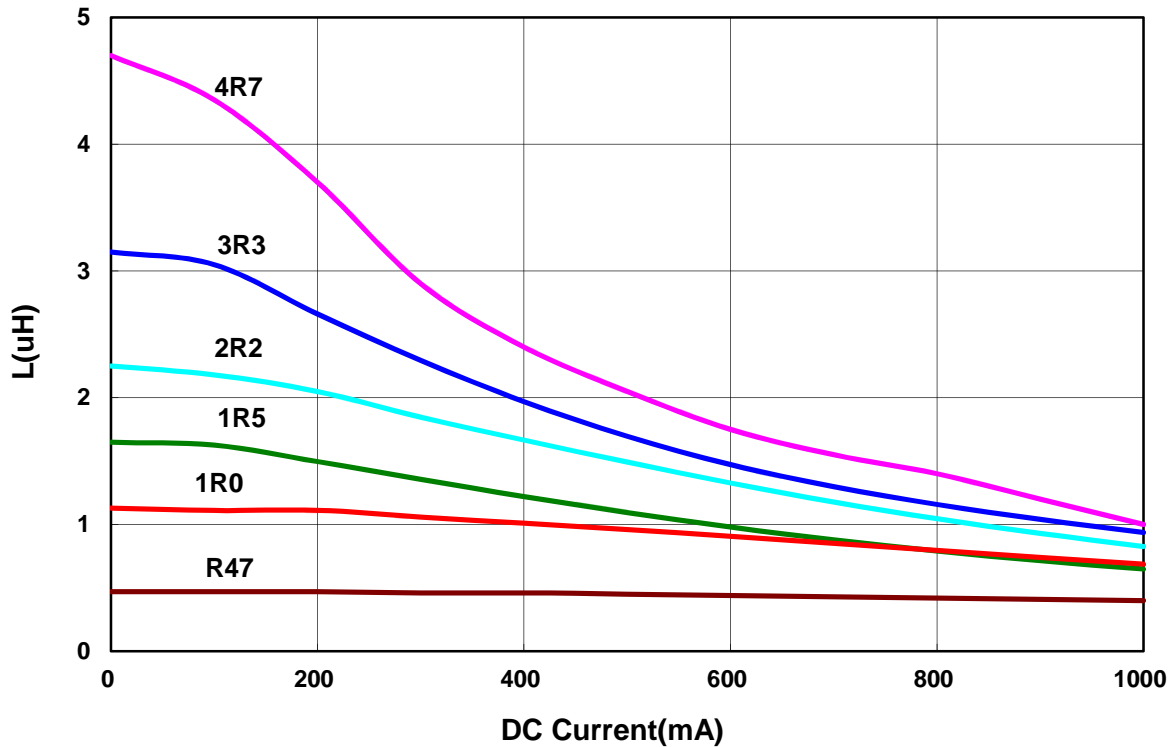

Please be sure to request approval specifications that provide further details of the products. Kindly note that the content of these specifications are subject to change or may be discontinued without prior notice. This product may not be designed/used in medical or high risk applications without Chilisin approval. Please contact our sales department before ordering.

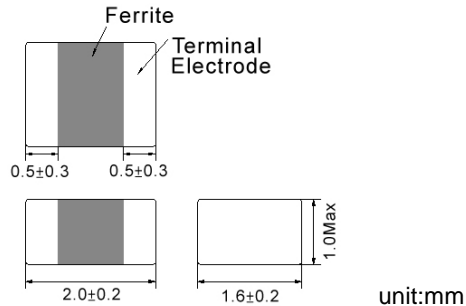
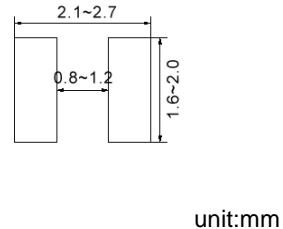
**AKPB00201610 Type**
**■ Dimensions**

**■ Recommended Land Pattern**

**■ Electrical Characteristics**

Part No.	Inductance	Test Freq.	RDC	Isat	Irms(mA)Max.		Tolerance
	(uH)				( $\Omega$ ) $\pm$ 25%	(mA)Max.	
AKPB00201610R47□A6	0.47	3MHz,200mV	0.06	1200	1600	1200	20,30
AKPB002016101R0□A6	1.0	3MHz,200mV	0.09	850	1300	950	20,30
AKPB002016101R5□A6	1.5	3MHz,200mV	0.11	600	1200	900	20,30
AKPB002016102R2□A6	2.2	3MHz,200mV	0.11	400	1200	900	20,30
AKPB002016103R3□A6	3.3	3MHz,200mV	0.12	350	850	625	20,30
AKPB002016104R7□A6	4.7	3MHz,200mV	0.14	200	1100	800	20,30

**Note: When ordering, please specify tolerance code. Tolerance: M= $\pm$ 20% / T= $\pm$ 30%**

- Operating temperature range - 55°C ~ 125°C
- Isat for Inductance drop 30% from its value without current
- Irms for When applied current to the Products, temperature rise caused by self-generated heat shall be limited to 40 °C max
- As for the Rated current marked with \*1, Rated Current is depending on the operating temperature
- Measure Equipment :  
 L : Agilent HP4287A+16197A  
 RDC : HP 4338B, or equivalent

**AKPB00201610 Type**

**Characteristics Graph**

**Inductance vs. Frequency Characteristics**

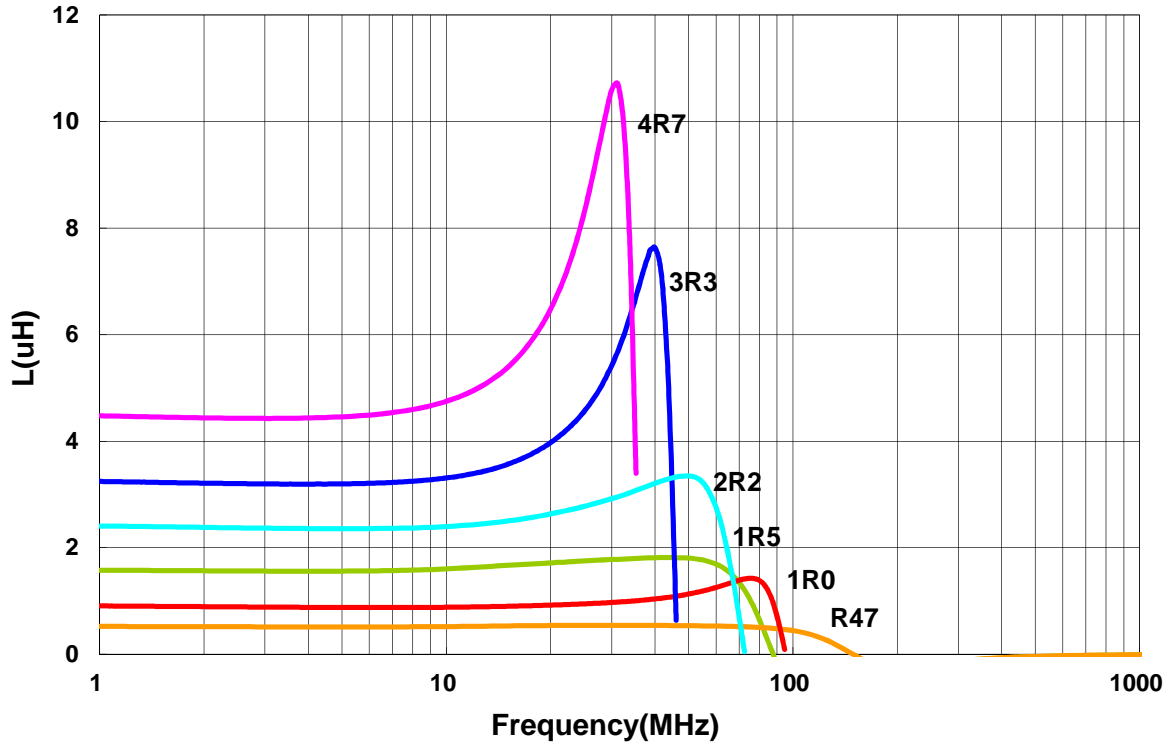

**Inductance vs. DC Current**

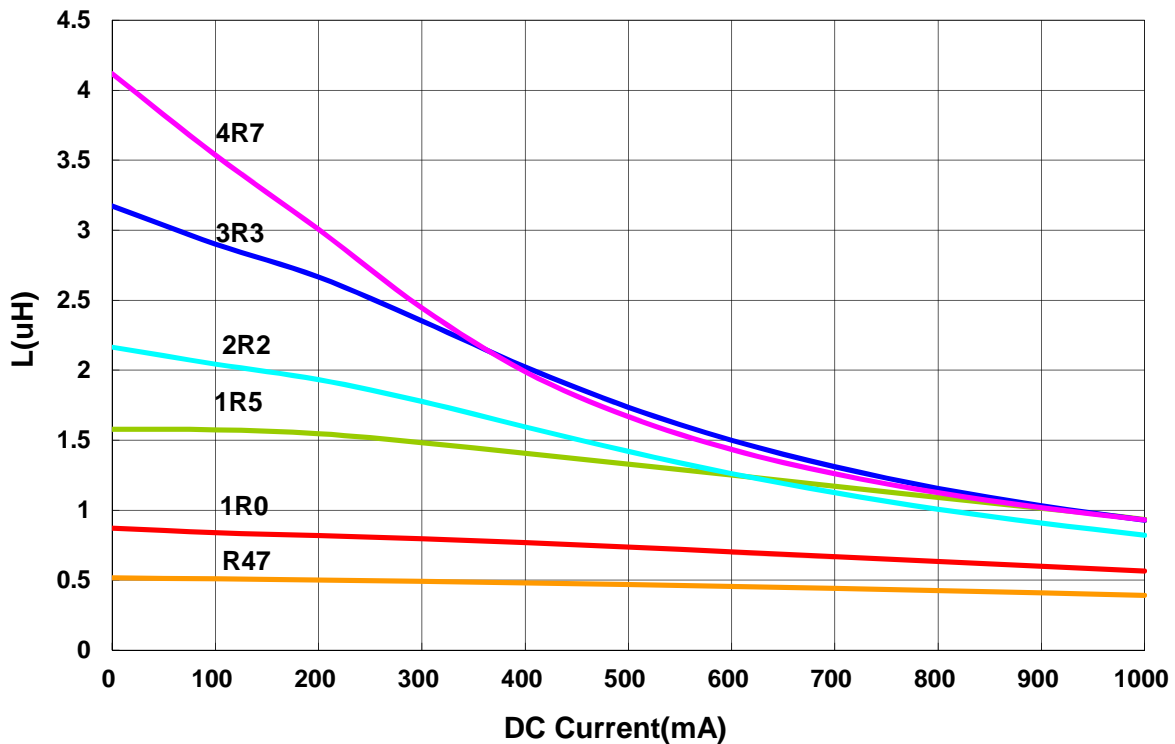

Please be sure to request approval specifications that provide further details of the products. Kindly note that the content of these specifications are subject to change or may be discontinued without prior notice. This product may not be designed/used in medical or high risk applications without Chilisin approval. Please contact our sales department before ordering.

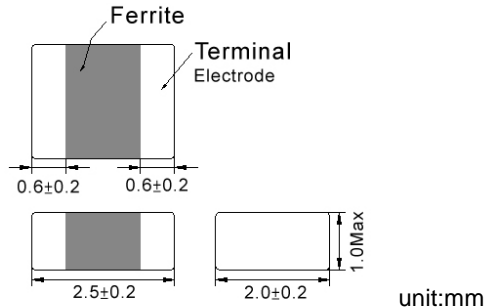
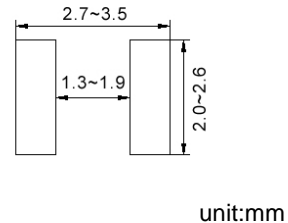
**AKPB00252010 Type**
**■ Dimensions**

**■ Recommended Land Pattern**

**■ Electrical Characteristics**

Part No.	Inductance	Test Freq.	RDC	Isat	Irms(mA)Max.		Tolerance
	(uH)				( $\Omega$ ) $\pm$ 25%	(mA)Max.	
AKPB00252010R47□A6	0.47	3MHz,200mV	0.040	1500	1800	1300	20,30
AKPB002520101R0□A6	1.0	3MHz,200mV	0.055	900	1600	1200	20,30
AKPB002520102R2□A6	2.2	3MHz,200mV	0.080	500	1300	950	20,30
AKPB002520103R3□A6	3.3	3MHz,200mV	0.100	400	1200	900	20,30
AKPB002520104R7□A6	4.7	3MHz,200mV	0.110	300	1100	800	20,30

**Note: When ordering, please specify tolerance code. Tolerance: M= $\pm$ 20% / T= $\pm$ 30%**

1. Operating temperature range - 55°C ~ 125°C
2. Isat for Inductance drop 30% from its value without current
3. Irms for When applied current to the Products, temperature rise caused by self-generated heat shall be limited to 40 °C max
4. As for the Rated current marked with \*1, Rated Current is depending on the operating temperature
5. Measure Equipment :  
 L : Agilent HP4287A+16197A  
 RDC : HP 4338B, or equivalent



AKPB00252010 Type

**Characteristics Graph**

**Inductance vs. Frequency Characteristics**

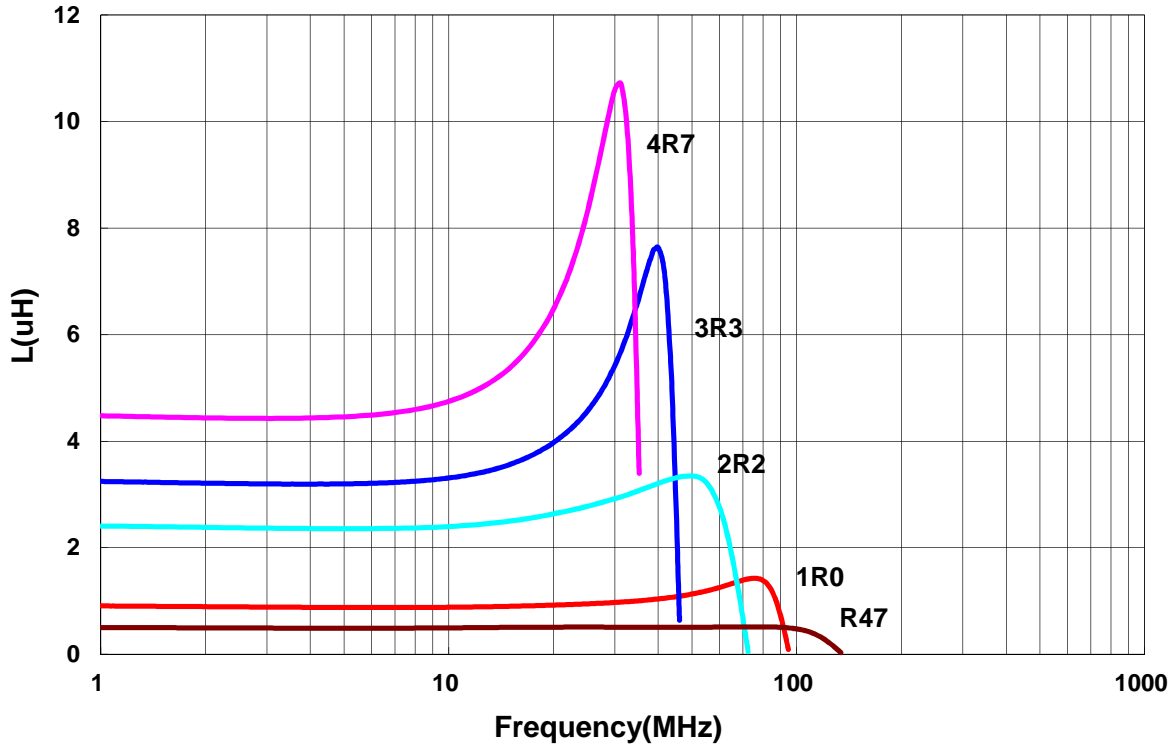

**Inductance vs. DC Current**

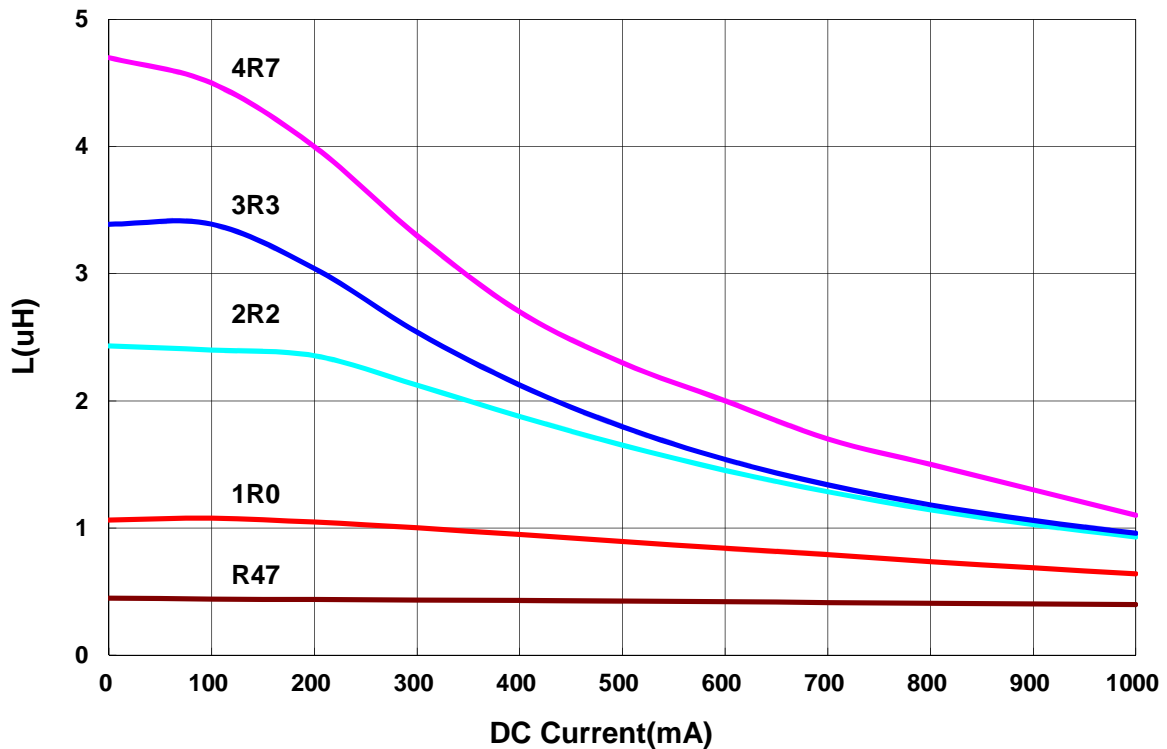

Please be sure to request approval specifications that provide further details of the products. Kindly note that the content of these specifications are subject to change or may be discontinued without prior notice. This product may not be designed/used in medical or high risk applications without Chilisin approval. Please contact our sales department before ordering.

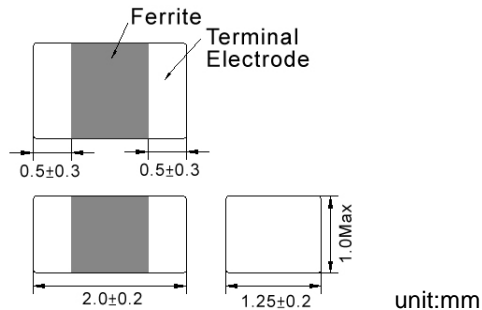
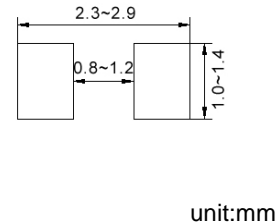
**AKPE00201210 Type**
**■ Dimensions**

**■ Recommended Land Pattern**

**■ Electrical Characteristics**

Part No.	Inductance	Test Freq.	RDC	Isat(mA)	Irms(mA)Max.		Tolerance
	(uH)			(Ω)±25%	Max.	85°C <sup>*1</sup>	
AKPE002012101R0□A2	1.0	3MHz,200mV	0.100	1400	1800	1300	20,30
AKPE002012102R2□A2	2.2	3MHz,200mV	0.125	500	1600	1200	20,30

**Note: When ordering, please specify tolerance code. Tolerance: M=±20% / T=±30%**

1. Operating temperature range - 55°C ~ 125°C
2. Isat for Inductance drop 30% from its value without current
3. Irms for When applied current to the Products, temperature rise caused by self-generated heat shall be limited to 40 °C max
4. As for the Rated current marked with \*1, Rated Current is depending on the operating temperature
5. Measure Equipment :  
 L : Agilent HP4287A+16197A  
 RDC : HP 4338B, or equivalent

**AKPE00201210 Type**

**■ Characteristics Graph**

**Inductance vs. DC Current**

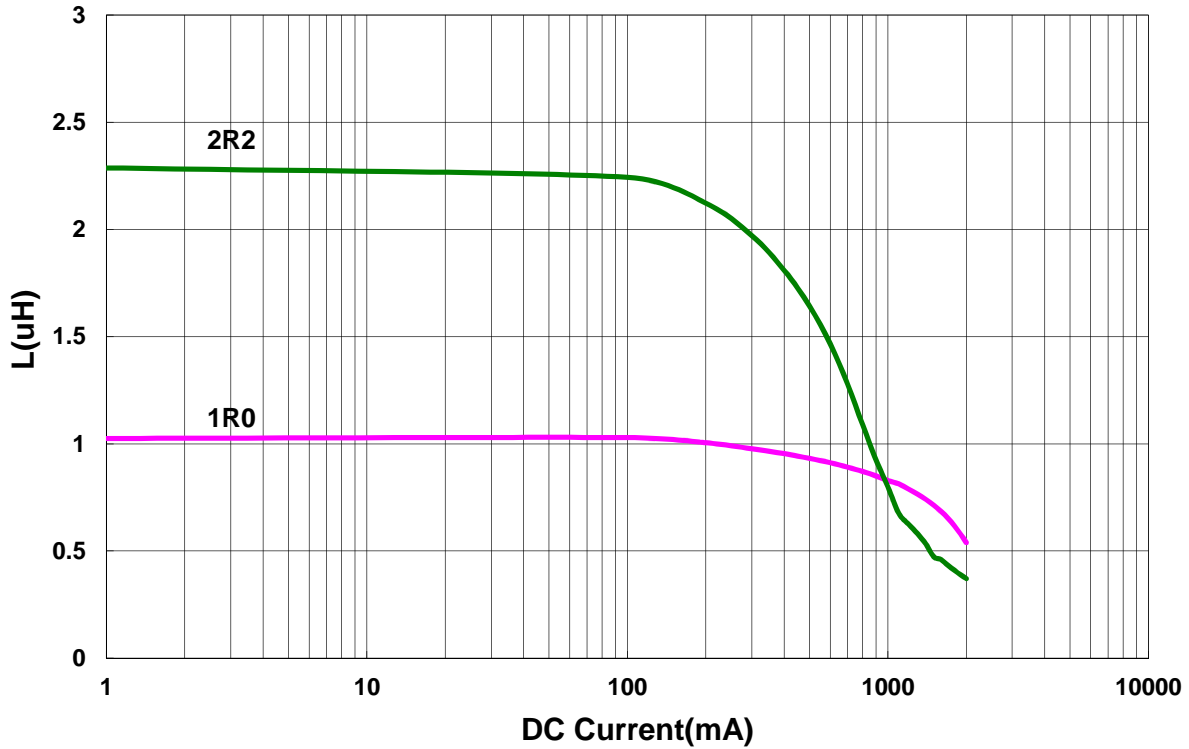

**Inductance vs. DC Current**

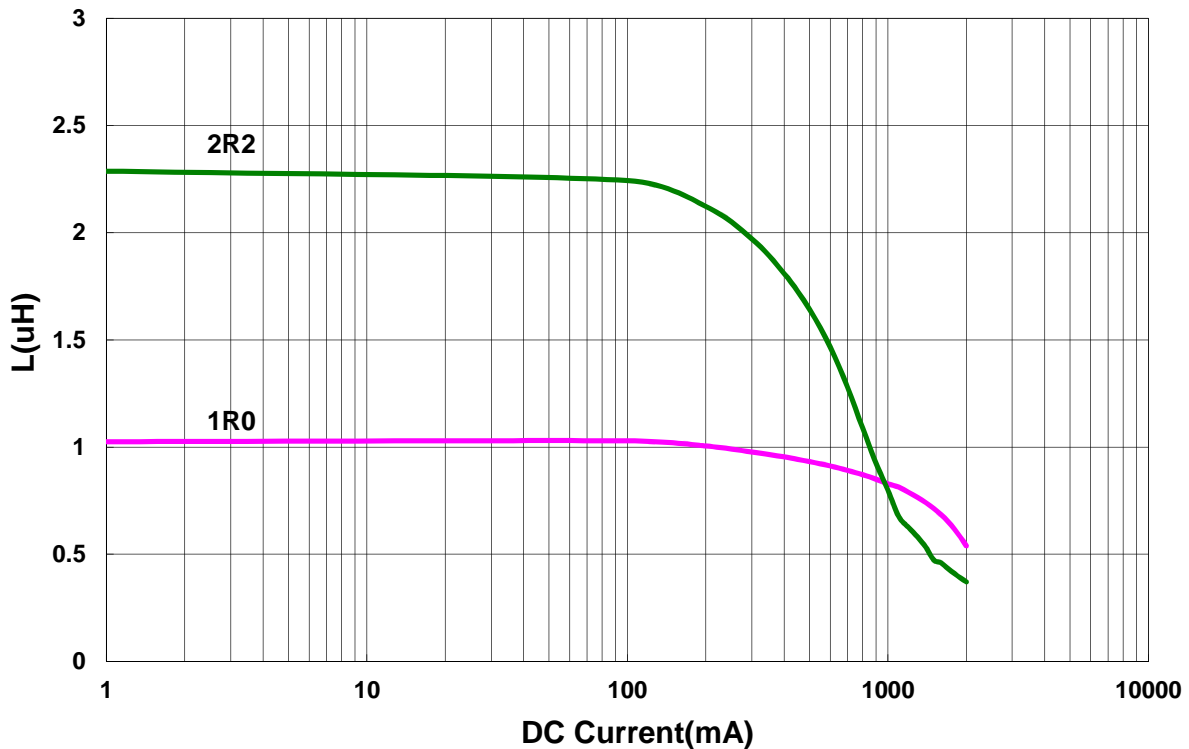

Please be sure to request approval specifications that provide further details of the products. Kindly note that the content of these specifications are subject to change or may be discontinued without prior notice. This product may not be designed/used in medical or high risk applications without Chilisin approval. Please contact our sales department before ordering.

**■ Packaging**

**Tape Dimensions**

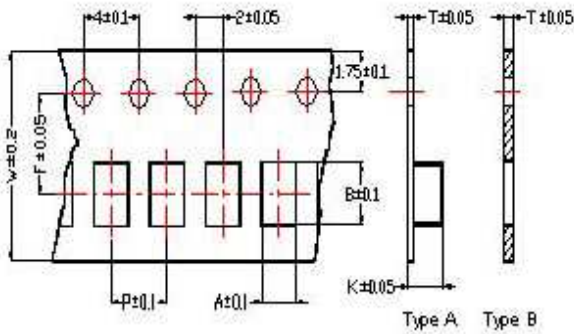

**Tape Material**

Carrier Tape: Polycarbonate (Tape A)  
Carrier Tape: Paper (Tape B)  
Cover Tape: Polystyrene

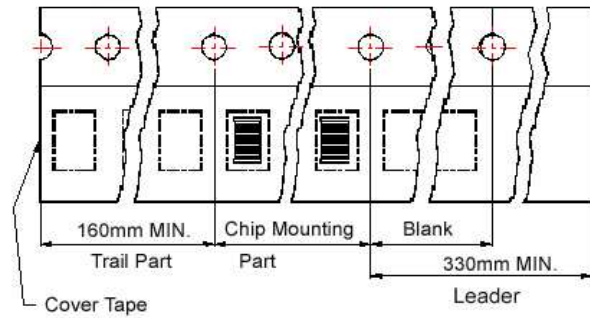

**Reel Dimensions**

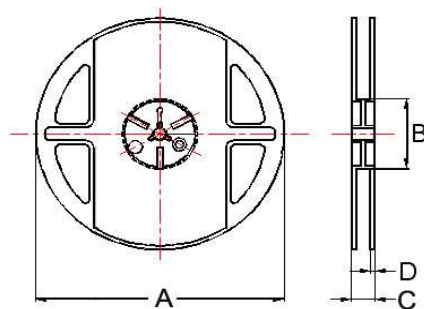

**Dimensions in mm**

TYPE	Tape Dimensions								Reel Dimensions				Quantity PCS / Reel
	A	B	T	W	P	F	K	Tape	A	B	C	D	
AKPx001608DZ	1.05	1.85	0.95	8	4	3.5	-	B	178	60	12	1.5	4000
AKPx00201210	1.45	2.25	0.22	8	4	3.5	1.04	A	178	60	12	1.5	3000
AKPx00201610	1.8	2.2	0.22	8	4	3.5	1.15	A	178	60	12	1.5	3000
AKPx00252010	2.25	2.8	0.25	8	4	3.5	1.35	A	178	60	12	1.5	3000