



## +2.7 V to +5.5 V, I<sup>2</sup>C INTERFACE, VOLTAGE OUTPUT, 10-BIT DIGITAL-TO-ANALOG CONVERTER

### FEATURES

- **Micropower Operation:** 125  $\mu$ A @ 3 V
- **Fast Update Rate:** 188 kSPS
- **Power-On Reset to Zero**
- **+2.7-V to +5.5-V Power Supply**
- **Specified Monotonic by Design**
- **I<sup>2</sup>C™ Interface up to 3.4 MBPS**
- **On-Chip Output Buffer Amplifier, Rail-to-Rail Operation**
- **Double-Buffered Input Register**
- **Address Support for up to Two DAC6571s**
- **Small SOT23-6 Package**
- **Operation From –40°C to +105°C**

### APPLICATIONS

- **Process Control**
- **Data Acquisition Systems**
- **Closed-Loop Servo Control**
- **PC Peripherals**
- **Portable Instrumentation**

### DESCRIPTION

The DAC6571 is a low-power, single-channel, 10-bit buffered voltage output digital-to-analog converter (DAC). Its on-chip precision output amplifier allows rail-to-rail output swing to be achieved. The DAC6571 utilizes an I<sup>2</sup>C-compatible, two-wire serial interface that operates at clock rates up to 3.4 MBPS with address support of up to two DAC6571s on the same data bus.

The output voltage range of the DAC is 0 V to V<sub>DD</sub>. The DAC6571 incorporates a power-on-reset circuit that ensures that the DAC output powers up at zero volts and remains there until a valid write to the device takes place. The DAC6571 contains a power-down feature, accessed via the internal control register, that reduces the current consumption of the device to 50 nA at 5 V.

The low power consumption of this part in normal operation makes it ideally suited for portable battery operated equipment. The power consumption is less than 0.7 mW at V<sub>DD</sub> = 5 V reducing to 1  $\mu$ W in power-down mode.

The DAC7571/6571/5571 are 12/10/8-bit, single-channel I<sup>2</sup>C DACs from the same family. The DAC7574/6574/5574 and DAC7573/6573/5573 are 12/10/8-bit, quad-channel I<sup>2</sup>C DACs. Also see the DAC8571/8574 for single/quad-channel, 16-bit I<sup>2</sup>C DACs.

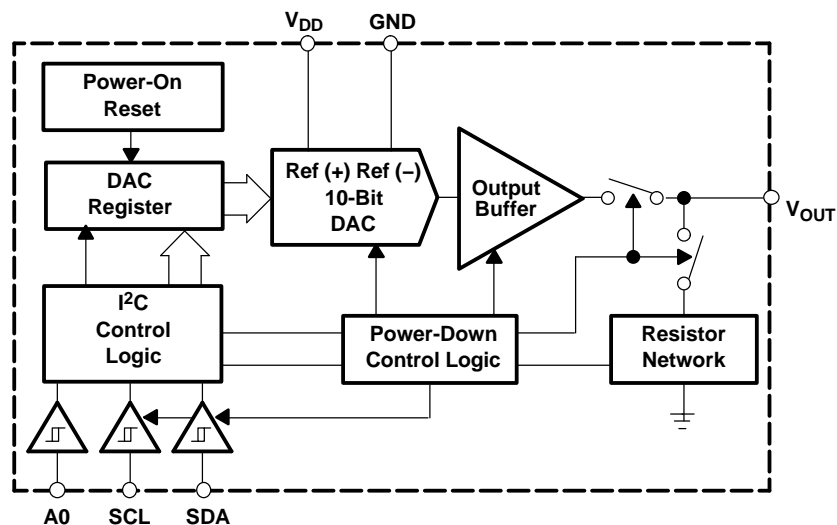

Please be aware that an important notice concerning availability, standard warranty, and use in critical applications of Texas Instruments semiconductor products and disclaimers thereto appears at the end of this data sheet.

I<sup>2</sup>C is a trademark of Philips Corporation.

 This integrated circuit can be damaged by ESD. Texas Instruments recommends that all integrated circuits be handled with appropriate precautions. Failure to observe proper handling and installation procedures can cause damage.

ESD damage can range from subtle performance degradation to complete device failure. Precision integrated circuits may be more susceptible to damage because very small parametric changes could cause the device not to meet its published specifications.

**PACKAGE/ORDERING INFORMATION<sup>(1)</sup>**

PRODUCT	PACKAGE	PACKAGE DESIGNATOR	SPECIFIED TEMPERATURE RANGE	PACKAGE MARKING	ORDERING NUMBER	TRANSPORT MEDIA
DAC6571	SOT23-6	DBV	- 40°C to +105°C	D671	DAC6571IDBVT	250 Piece Small Tape and Reel
					DAC6571IDBVR	3000 Piece Tape and Reel

(1) For the most current package and ordering information see the Package Option Addendum at the end of this datasheet, or see the TI web site at [www.ti.com](http://www.ti.com).

**PIN CONFIGURATIONS**

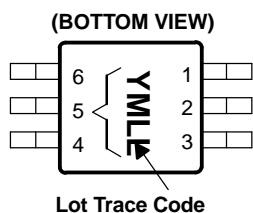
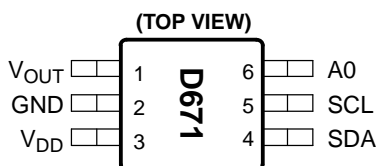

**PIN DESCRIPTION (SOT23-6)**

PIN	NAME	DESCRIPTION
1	V <sub>OUT</sub>	Analog output voltage from DAC
2	GND	Ground reference point for all circuitry on the part
3	V <sub>DD</sub>	Analog Voltage Supply Input
4	SDA	Serial Data Input
5	SCL	Serial Clock Input
6	A0	Device Address Select
LOT TRACE CODE:	Year (3 = 2003); M onth (1–9 = JAN–SEP; A = OCT, B = NOV, C = DEC); LL — Random code generated when assembly is requested.	

**ABSOLUTE MAXIMUM RATINGS<sup>(1)</sup>**

	UNITS	
V <sub>DD</sub> to GND	-0.3 V to +6 V	
Digital input voltage to GND	-0.3 V to +V <sub>DD</sub> + 0.3 V	
V <sub>OUT</sub> to GND	-0.3 V to +V <sub>DD</sub> + 0.3 V	
Operating temperature range	-40°C to + 105°C	
Storage temperature range	-65°C to + 150°C	
Junction temperature range (T <sub>J</sub> max)	+150°C	
Power dissipation	(T <sub>J</sub> max - T <sub>A</sub> )R <sub>θJA</sub>	
Thermal impedance, R <sub>θJA</sub>	240°C/W	
Lead temperature, soldering	Vapor phase (60s)	215°C
	Infrared (15s)	220°C

(1) Stresses above those listed under *Absolute Maximum Ratings* may cause permanent damage to the device. Exposure to absolute maximum conditions for extended periods may affect device reliability.

**ELECTRICAL CHARACTERISTICS**
 $V_{DD} = +2.7\text{ V to }+5.5\text{ V}$ ;  $R_L = 2\text{ k}\Omega$  to GND;  $C_L = 200\text{ pF}$  to GND; all specifications  $-40^\circ\text{C to }+105^\circ\text{C}$  unless otherwise noted.

PARAMETER	CONDITIONS	DAC6571			UNITS
		MIN	TYP	MAX	
<b>STATIC PERFORMANCE<sup>(1)</sup></b>					
Resolution		10			Bits
Relative accuracy				$\pm 2$	LSB
Differential nonlinearity	Assured monotonic by design			$\pm 0.5$	LSB
Zero code error			5	20	mV
Full-scale error	All ones loaded to DAC register		-0.15	-1.25	% of FSR
Gain error				$\pm 1.25$	% of FSR
Zero code error drift			$\pm 7$		$\mu\text{V}/^\circ\text{C}$
Gain temperature coefficient			$\pm 3$		ppm of FSR/ $^\circ\text{C}$
<b>OUTPUT CHARACTERISTICS<sup>(2)</sup></b>					
Output voltage range		0		$V_{DD}$	V
Output voltage settling time	1/4 Scale to 3/4 scale change ( $400_H$ to $C00_H$ ); $R_L = \infty$		7	9	$\mu\text{s}$
Slew rate			1		V/ $\mu\text{s}$
Capacitive load stability	$R_L = \infty$		470		pF
	$R_L = 2\text{ k}\Omega$		1000		pF
Code change glitch impulse	1 LSB Change around major carry		20		nV – s
Digital feedthrough			0.5		nV – s
DC output impedance			1		$\Omega$
Short-circuit current	$V_{DD} = +5\text{ V}$		50		mA
	$V_{DD} = +3\text{ V}$		20		mA
Power-up time	Coming out of power-down mode, $V_{DD} = +5\text{ V}$		2.5		$\mu\text{s}$
	Coming out of power-down mode, $V_{DD} = +3\text{ V}$		5		$\mu\text{s}$
<b>LOGIC INPUTS<sup>(2)</sup></b>					
Input current				$\pm 1$	$\mu\text{A}$
$V_{INL}$ , Input low voltage	$V_{DD} = +3\text{ V}$			$0.3 \times V_{DD}$	V
$V_{INH}$ , Input high voltage	$V_{DD} = +5\text{ V}$	$0.7 \times V_{DD}$			V
Pin capacitance				3	pF
<b>POWER REQUIREMENTS</b>					
$V_{DD}$		2.7		5.5	V
$I_{DD}$ (normal operation)	DAC active and excluding load current				
$V_{DD} = +3.6\text{ V to }+5.5\text{ V}$	$V_{IH} = V_{DD}$ and $V_{IL} = \text{GND}$		155	200	$\mu\text{A}$
$V_{DD} = +2.7\text{ V to }+3.6\text{ V}$	$V_{IH} = V_{DD}$ and $V_{IL} = \text{GND}$		125	160	$\mu\text{A}$
$I_{DD}$ (all power-down modes)					
$V_{DD} = +3.6\text{ V to }+5.5\text{ V}$	$V_{IH} = V_{DD}$ and $V_{IL} = \text{GND}$		0.2	1	$\mu\text{A}$
$V_{DD} = +2.7\text{ V to }+3.6\text{ V}$	$V_{IH} = V_{DD}$ and $V_{IL} = \text{GND}$		0.05	1	$\mu\text{A}$
<b>POWER EFFICIENCY</b>					
$I_{OUT}/I_{DD}$	$I_{LOAD} = 2\text{ mA}$ , $V_{DD} = +5\text{ V}$		93		%

(1) Linearity calculated using a reduced code range of 12 to 1012; output unloaded.

(2) Specified by design and characterization; not production tested.

**TIMING CHARACTERISTICS**

SYMBOL	PARAMETER	TEST CONDITIONS	MIN	TYP	MAX	UNITS
f <sub>SCL</sub>	SCL Clock Frequency	Standard mode			100	kHz
		Fast mode			400	kHz
		High-speed mode, C <sub>B</sub> – 100 pF max			3.4	MHz
		High-Speed mode, C <sub>B</sub> – 400 pF max			1.7	MHz
t <sub>BUF</sub>	Bus Free Time Between a STOP and START Condition	Standard mode	4.7			μs
		Fast mode	1.3			μs
t <sub>HD</sub> ; t <sub>STA</sub>	Hold Time (Repeated) START Condition	Standard mode	4.0			μs
		Fast mode	600			ns
		High-speed mode	160			ns
t <sub>LOW</sub>	LOW Period of the SCL Clock	Standard mode	4.7			μs
		Fast mode	1.3			μs
		High-speed mode, C <sub>B</sub> – 100 pF max	160			ns
		High-speed mode, C <sub>B</sub> – 400 pF max	320			ns
t <sub>HIGH</sub>	HIGH Period of the SCL Clock	Standard mode	4.0			μs
		Fast mode	600			ns
		High-speed mode, C <sub>B</sub> – 100 pF max	60			ns
		High-speed mode, C <sub>B</sub> – 400 pF max	120			ns
t <sub>SU</sub> ; t <sub>STA</sub>	Setup Time for a Repeated START Condition	Standard mode	4.7			μs
		Fast mode	600			ns
		High-speed mode	160			ns
t <sub>SU</sub> ; t <sub>DAT</sub>	Data Setup Time	Standard mode	250			ns
		Fast mode	100			ns
		High-speed mode	10			ns
t <sub>HD</sub> ; t <sub>DAT</sub>	Data Hold Time	Standard mode	0		3.45	μs
		Fast mode	0		0.9	μs
		High-speed mode, C <sub>B</sub> – 100 pF max	0		70	ns
		High-speed mode, C <sub>B</sub> – 400 pF max	0		150	ns
t <sub>RCL</sub>	Rise Time of SCL Signal	Standard mode			1000	ns
		Fast mode	20 + 0.1C <sub>B</sub>		300	ns
		High-speed mode, C <sub>B</sub> – 100 pF max	10		40	ns
		High-speed mode, C <sub>B</sub> – 400 pF max	20		80	ns
t <sub>RCL1</sub>	Rise Time of SCL Signal After a Repeated START Condition and After an Acknowledge BIT	Standard mode			1000	ns
		Fast mode	20 + 0.1C <sub>B</sub>		300	ns
		High-speed mode, C <sub>B</sub> – 100 pF max	10		80	ns
		High-speed mode, C <sub>B</sub> – 400 pF max	20		160	ns
t <sub>FCL</sub>	Fall Time of SCL Signal	Standard mode			300	ns
		Fast mode	20 + 0.1C <sub>B</sub>		300	ns
		High-speed mode, C <sub>B</sub> – 100 pF max	10		40	ns
		High-speed mode, C <sub>B</sub> – 400 pF max	20		80	ns
t <sub>RDA</sub>	Rise Time of SDA Signal	Standard mode			1000	ns
		Fast mode	20 + 0.1C <sub>B</sub>		300	ns
		High-speed mode, C <sub>B</sub> – 100 pF max	10		80	ns
		High-speed mode, C <sub>B</sub> – 400 pF max	20		160	ns
t <sub>FDA</sub>	Fall Time of SDA Signal	Standard mode			300	ns
		Fast mode	20 + 0.1C <sub>B</sub>		300	ns
		High-speed mode, C <sub>B</sub> – 100 pF max	10		80	ns
		High-speed mode, C <sub>B</sub> – 400 pF max	20		160	ns

**TIMING CHARACTERISTICS (continued)**

SYMBOL	PARAMETER	TEST CONDITIONS	MIN	TYP	MAX	UNITS
$t_{SU}; t_{STO}$	Setup Time for STOP Condition	Standard mode	4.0			$\mu\text{s}$
		Fast mode	600			ns
		High-speed mode	160			ns
$C_B$	Capacitive Load for SDA and SCL				400	pF
$t_{SP}$	Pulse Width of Spike Suppressed	Fast mode			50	ns
		High-speed mode			10	ns
$V_{NH}$	Noise Margin at the HIGH Level for Each Connected Device (Including Hysteresis)	Standard mode	0.2 $V_{DD}$			V
		Fast mode				
		High-speed mode				
$V_{NL}$	Noise Margin at the LOW Level for Each Connected Device (Including Hysteresis)	Standard mode	0.1 $V_{DD}$			V
		Fast mode				
		High-speed mode				

**TYPICAL CHARACTERISTICS:  $V_{DD} = +5\text{ V}$**

At  $T_A = +25^\circ\text{C}$ ,  $+V_{DD} = +5\text{ V}$ , unless otherwise noted.

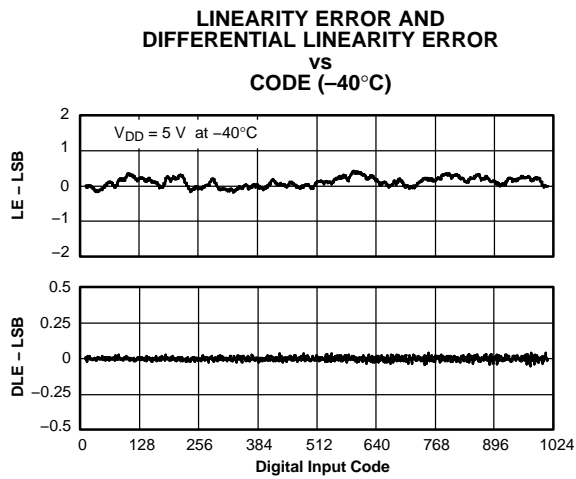

Figure 1.

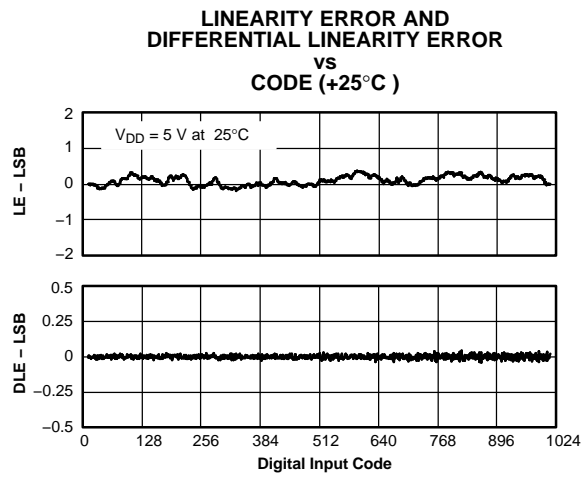

Figure 2.

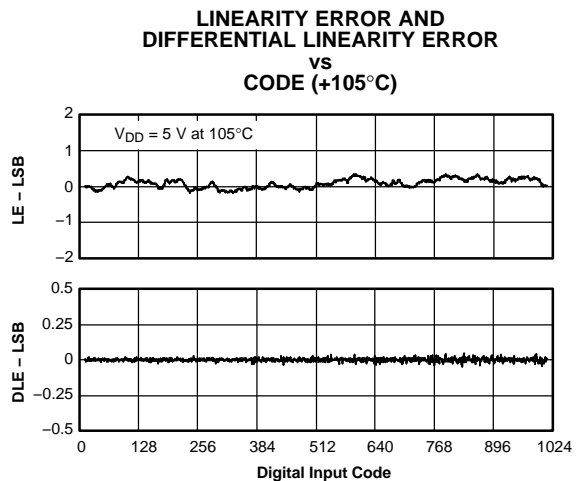

Figure 3.

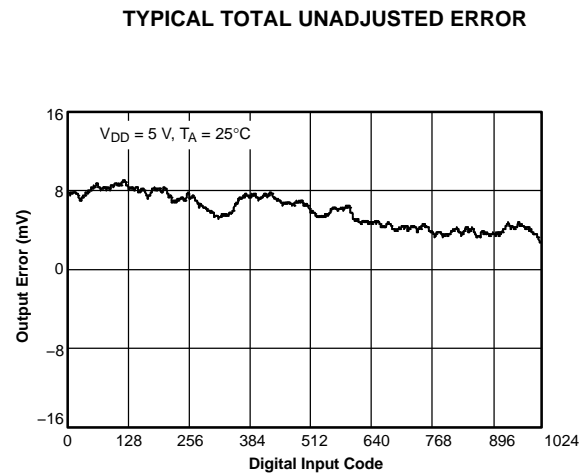

Figure 4.

**TYPICAL CHARACTERISTICS:  $V_{DD} = +5\text{ V}$  (continued)**

At  $T_A = +25^\circ\text{C}$ ,  $+V_{DD} = +5\text{ V}$ , unless otherwise noted.

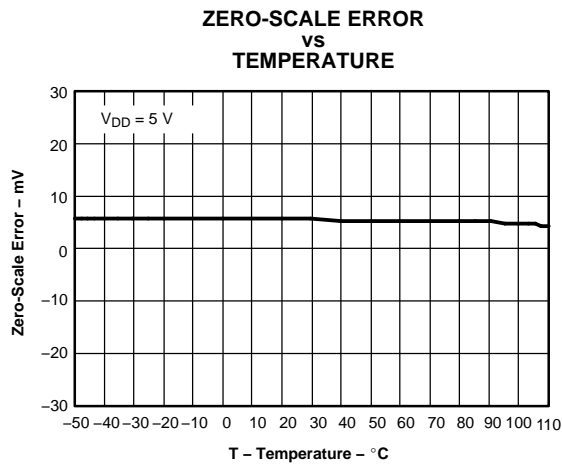

Figure 5.

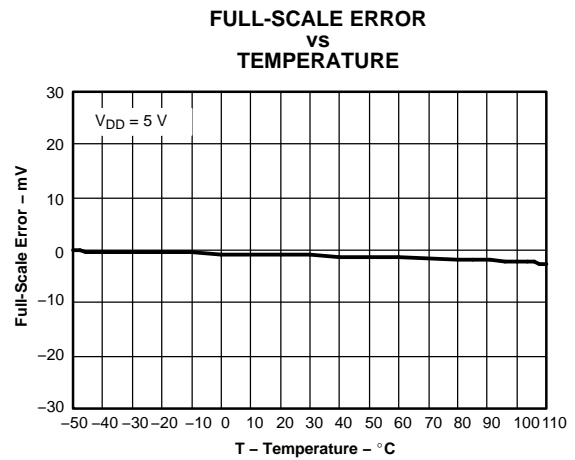

Figure 6.

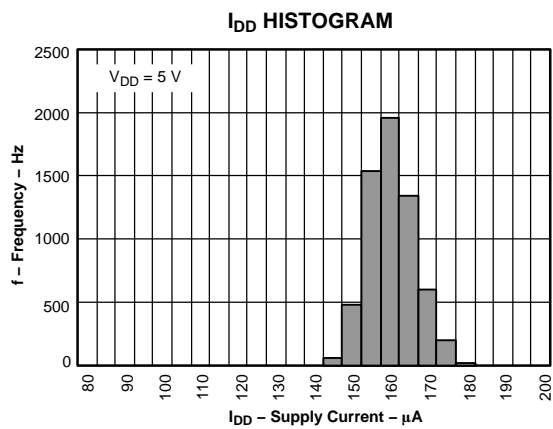

Figure 7.

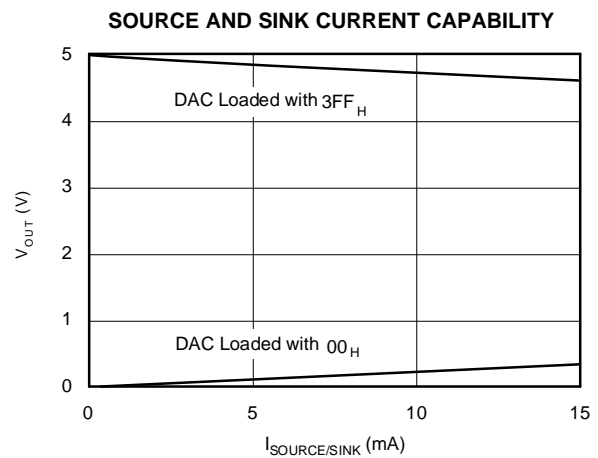

Figure 8.

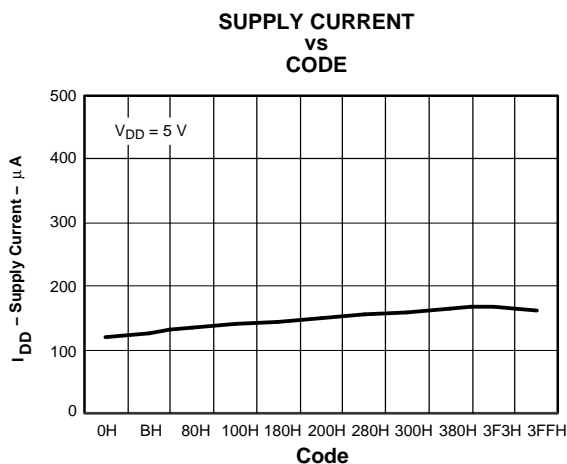

Figure 9.

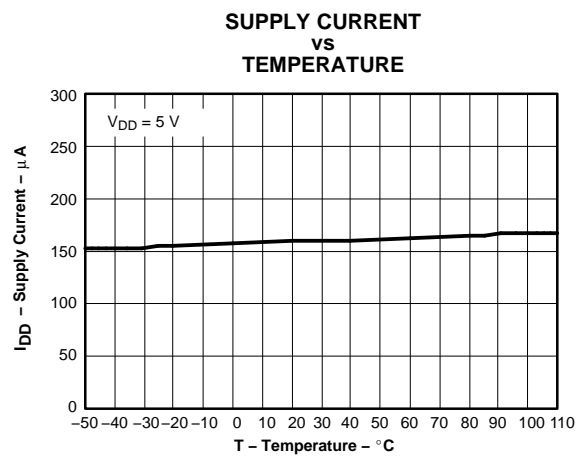

Figure 10.

**TYPICAL CHARACTERISTICS:  $V_{DD} = +5\text{ V}$  (continued)**

At  $T_A = +25^\circ\text{C}$ ,  $+V_{DD} = +5\text{ V}$ , unless otherwise noted.

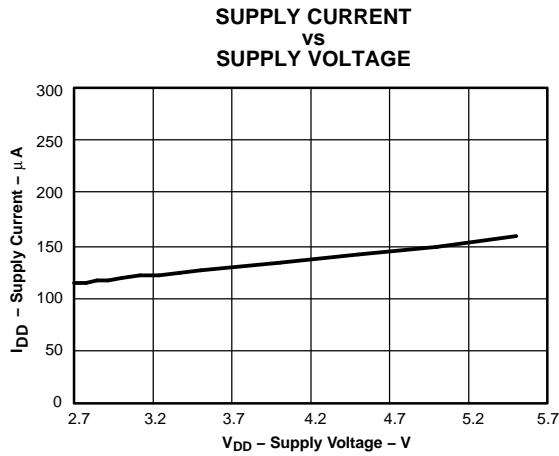

Figure 11.

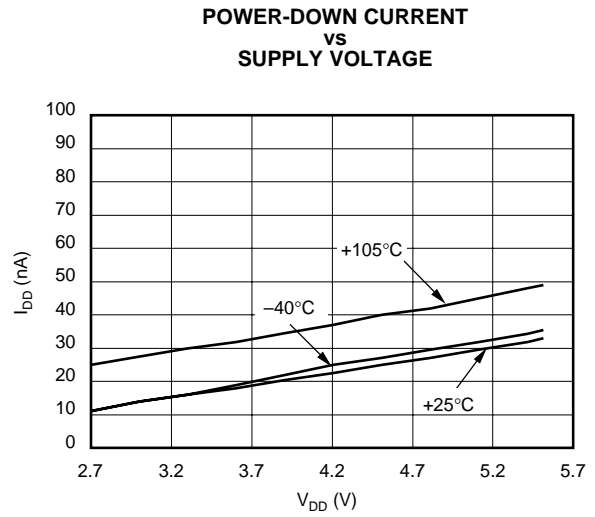

Figure 12.

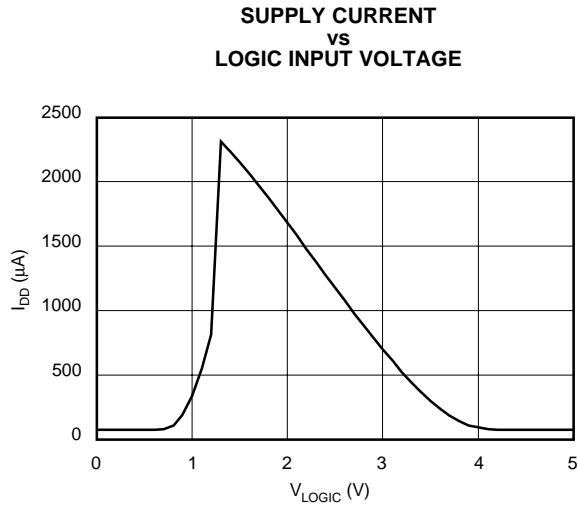

Figure 13.

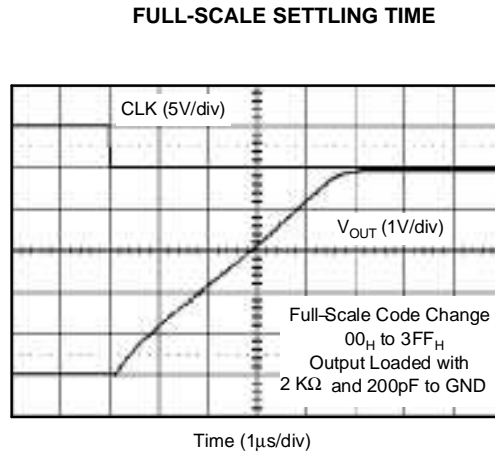
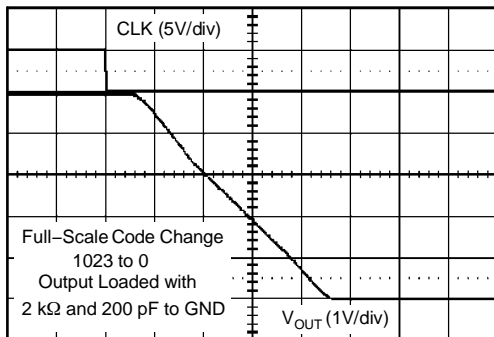

Figure 14.

**TYPICAL CHARACTERISTICS:  $V_{DD} = +5\text{ V}$  (continued)**

At  $T_A = +25^\circ\text{C}$ ,  $+V_{DD} = +5\text{ V}$ , unless otherwise noted.

**FULL-SCALE SETTLING TIME**



Time 1  $\mu\text{s}/\text{div}$

**Figure 15.**

**HALF-SCALE SETTLING TIME**

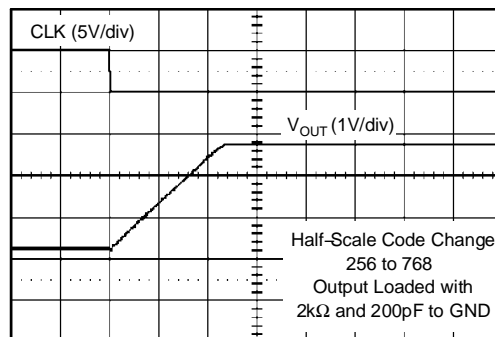

Time (1  $\mu\text{s}/\text{div}$ )

**Figure 16.**

**HALF-SCALE SETTLING TIME**

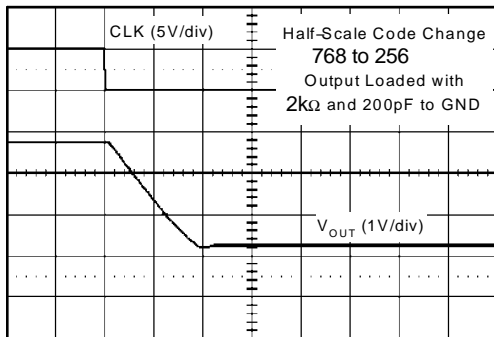

Time (1  $\mu\text{s}/\text{div}$ )

**Figure 17.**

**POWER-ON RESET TO 0 V**

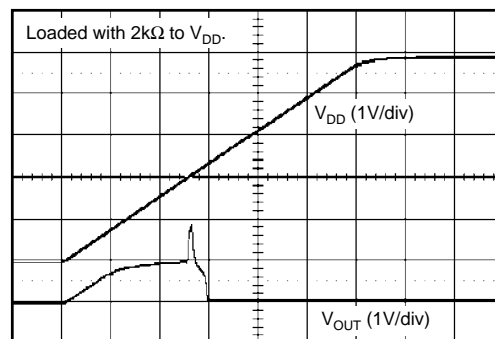

Time (20  $\mu\text{s}/\text{div}$ )

**Figure 18.**

**EXITING POWER DOWN  
(512 Loaded)**

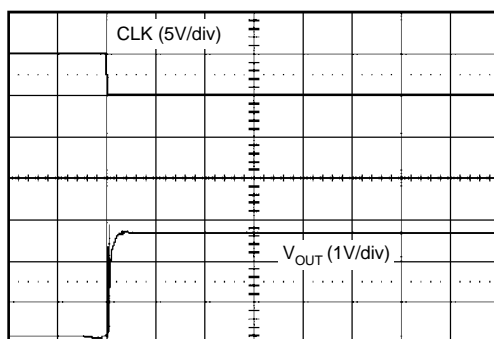

Time (5  $\mu\text{s}/\text{div}$ )

**Figure 19.**

**CODE CHANGE GLITCH**

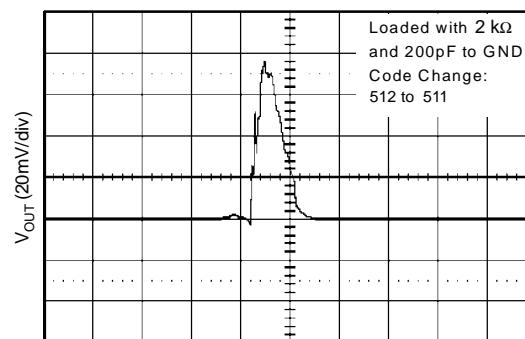

Time (0.5  $\mu\text{s}/\text{div}$ )

**Figure 20.**



**TYPICAL CHARACTERISTICS:  $V_{DD} = +2.7\text{ V}$**

At  $T_A = +25^\circ\text{C}$ ,  $+V_{DD} = +2.7\text{ V}$ , unless otherwise noted.

**LINEARITY ERROR AND  
DIFFERENTIAL LINEARITY ERROR  
vs  
CODE ( $-40^\circ\text{C}$ )**

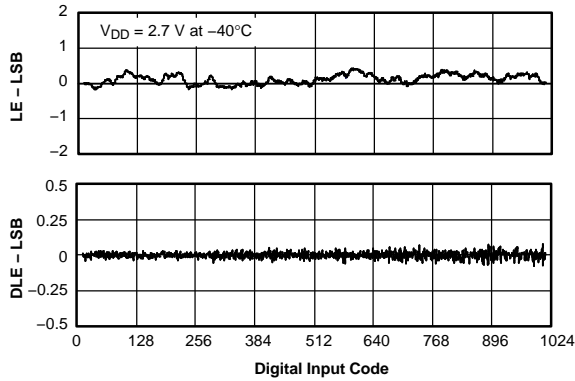

Figure 21.

**LINEARITY ERROR AND  
DIFFERENTIAL LINEARITY ERROR  
vs  
CODE ( $+25^\circ\text{C}$ )**

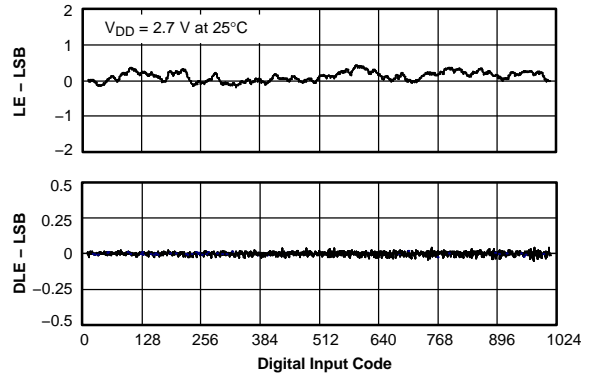

Figure 22.

**LINEARITY ERROR AND  
DIFFERENTIAL LINEARITY ERROR  
vs  
CODE ( $+105^\circ\text{C}$ )**

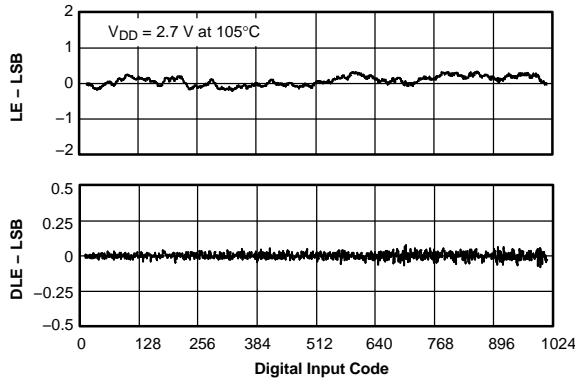

Figure 23.

**OUTPUT ERROR  
vs  
CODE ( $+25^\circ\text{C}$ )**

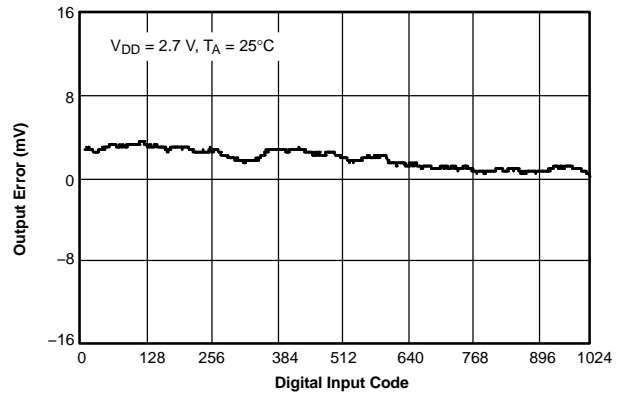

Figure 24.

**ZERO-SCALE ERROR  
vs  
TEMPERATURE**

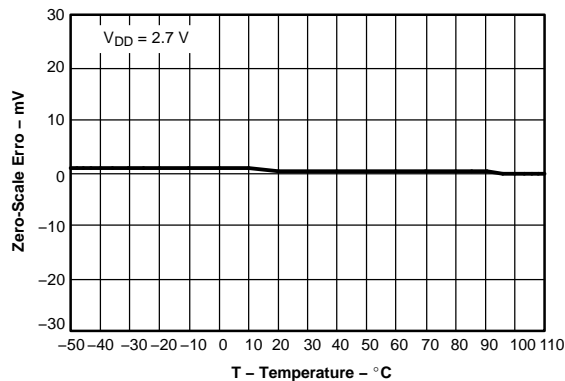

Figure 25.

**FULL-SCALE ERROR  
vs  
TEMPERATURE**

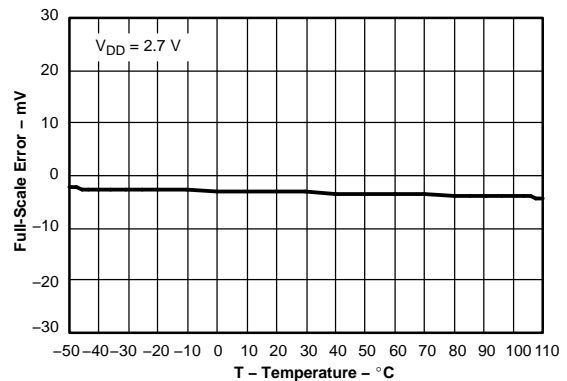

Figure 26.

**TYPICAL CHARACTERISTICS:  $V_{DD} = +2.7\text{ V}$  (continued)**

At  $T_A = +25^\circ\text{C}$ ,  $+V_{DD} = +2.7\text{ V}$ , unless otherwise noted.

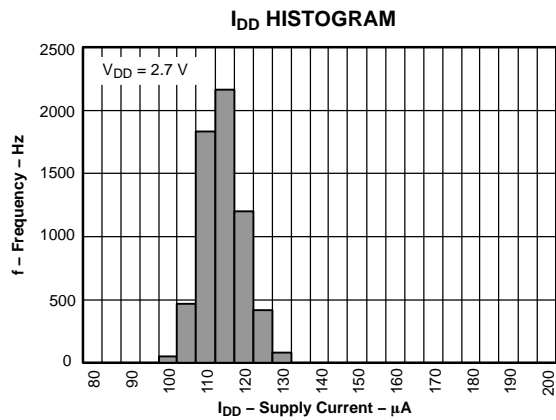

Figure 27.

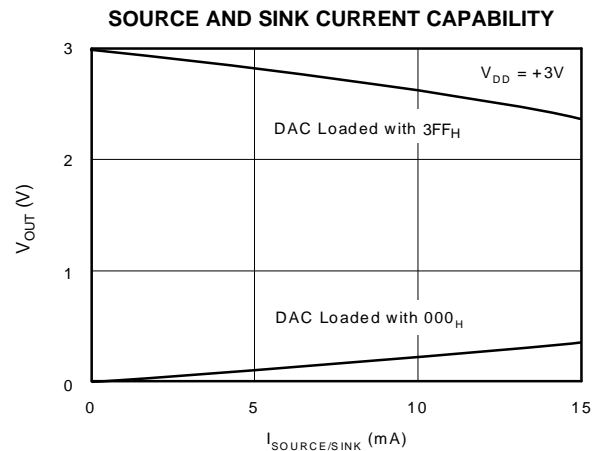

Figure 28.

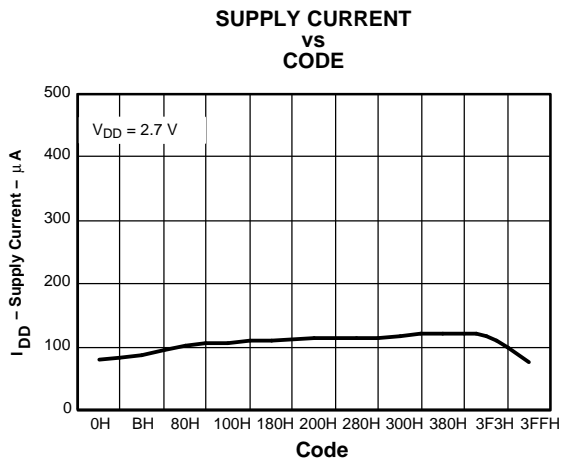

Figure 29.

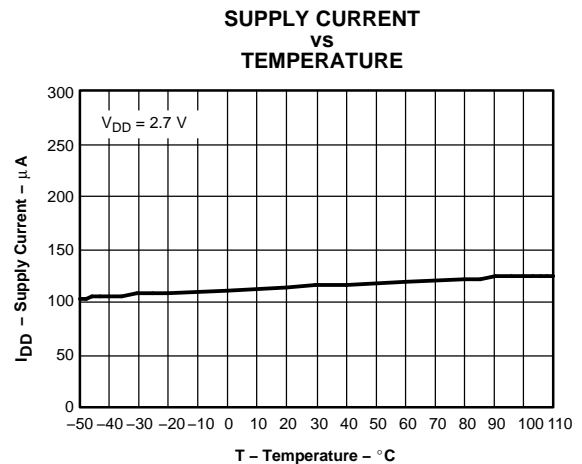

Figure 30.

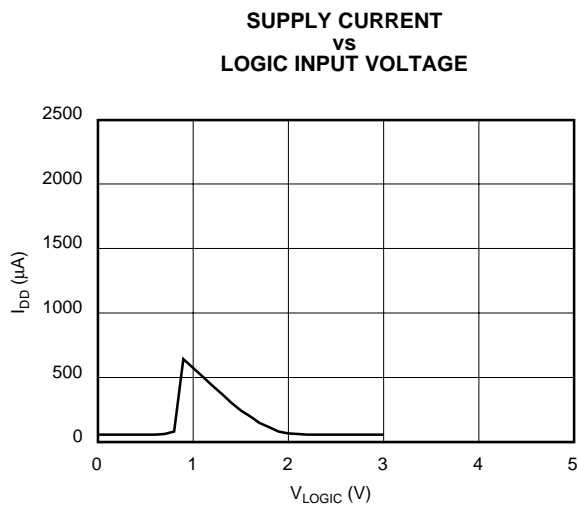

Figure 31.

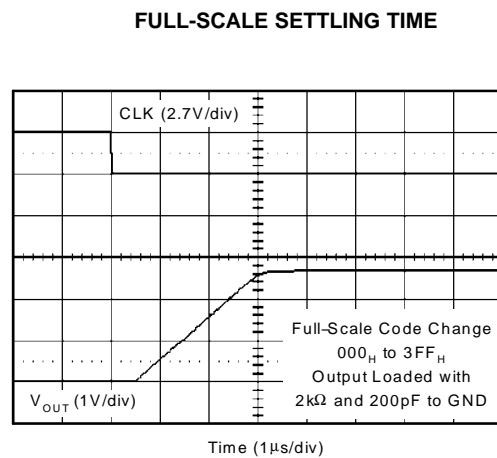
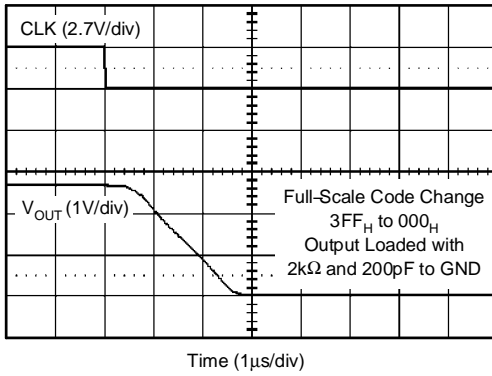

Figure 32.

**TYPICAL CHARACTERISTICS:  $V_{DD} = +2.7\text{ V}$  (continued)**

At  $T_A = +25^\circ\text{C}$ ,  $+V_{DD} = +2.7\text{ V}$ , unless otherwise noted.

**FULL-SCALE SETTLING TIME**



**Figure 33.**

**HALF-SCALE SETTLING TIME**

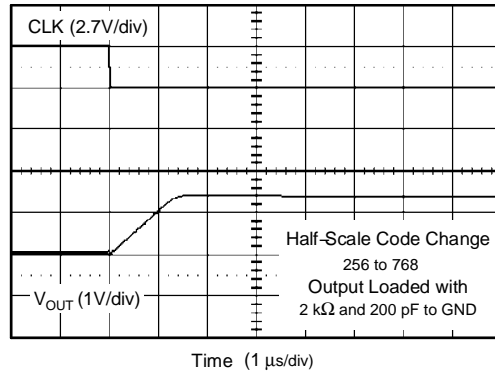

**Figure 34.**

**HALF-SCALE SETTLING TIME**

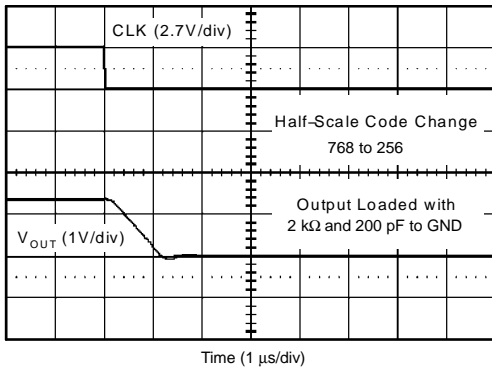

**Figure 35.**

**POWER-ON RESET 0 V**

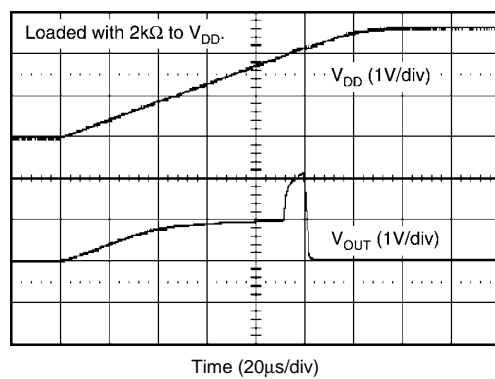

**Figure 36.**

**EXITING POWER DOWN (512 Loaded)**

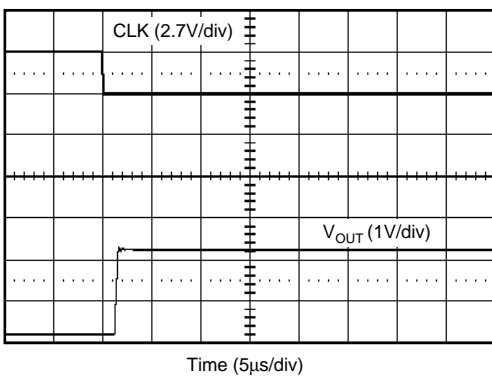

**Figure 37.**

**CODE CHANGE GLITCH**

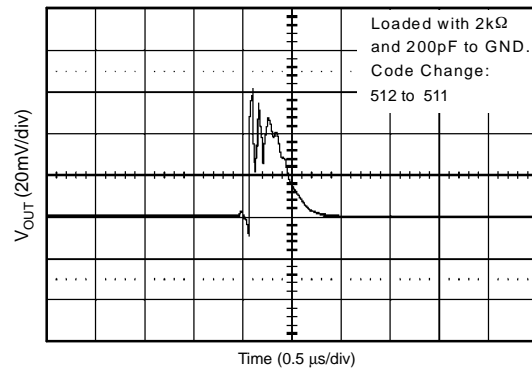

**Figure 38.**

## THEORY OF OPERATION

### D/A SECTION

The architecture of the DAC6571 consists of a string DAC followed by an output buffer amplifier. Figure 39 shows a generalized block diagram of the DAC architecture.

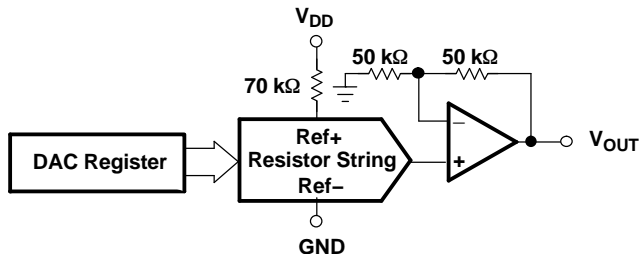

Figure 39. R-String DAC Architecture

The input coding to the DAC6571 is unsigned binary, which gives the ideal output voltage as:

$$V_{\text{OUT}} = V_{\text{DD}} \times \frac{D}{1024}$$

Where D = decimal equivalent of the binary code that is loaded to the DAC register; it can range from 0 to 1023.

### RESISTOR STRING

The resistor string section is shown in Figure 40. It is basically a divide-by-2 resistor, followed by a string of resistors, each of value R. The code loaded into the DAC register determines at which node on the string the voltage is tapped off to be fed into the output amplifier by closing one of the switches connecting the string to the amplifier. Because the architecture consists of a string of resistors, it is specified monotonic.

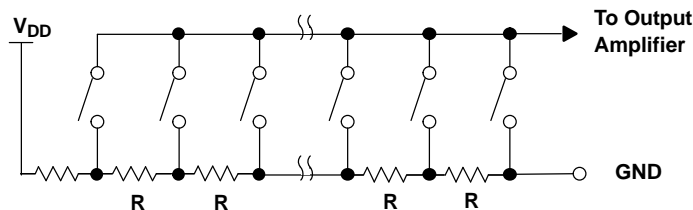

Figure 40. Typical Resistor String

### Output Amplifier

The output buffer amplifier is a gain-of-2 amplifier, capable of generating rail-to-rail voltages on its output, which gives an output range of 0 V to  $V_{\text{DD}}$ . It is capable of driving a load of 2 kΩ in parallel with 1000 pF to GND. The source and sink capabilities of the output amplifier can be seen in the typical characteristics curves. The slew rate is 1 V/μs with a half-scale settling time of 7 μs with the output unloaded.

### I<sup>2</sup>C Interface

I<sup>2</sup>C is a two-wire serial interface developed by Philips Semiconductor (see I<sup>2</sup>C-Bus Specification, Version 2.1, January 2000). The bus consists of a data line (SDA) and a clock line (SCL) with pull-up structures. When the bus is *idle*, both SDA and SCL lines are pulled high. All the I<sup>2</sup>C-compatible devices connect to the I<sup>2</sup>C bus through open drain I/O pins, SDA and SCL. A *master* device, usually a microcontroller or a digital signal processor, controls the bus. The master is responsible for generating the SCL signal and device addresses. The master also generates specific conditions that indicate the START and STOP of data transfer. A *slave* device receives and/or transmits data on the bus under control of the master device.

The DAC6571 works as a slave and supports the following data transfer modes, as defined in the I<sup>2</sup>C-Bus

## THEORY OF OPERATION (continued)

Specification: standard mode (100 kbps), fast mode (400 kbps), and high-speed mode (3.4 MBPS). The data transfer protocol for standard and fast modes is exactly the same; therefore, they are referred to as F/S-mode in this document. The protocol for high-speed mode is different from the F/S-mode, and it is referred to as HS-mode. The DAC6571 supports 7-bit addressing; 10-bit addressing and general call address are not supported.

### F/S-Mode Protocol

- The *master* initiates data transfer by generating a *start condition*. A *start condition* is initiated when a high-to-low transition occurs on the SDA line while SCL is high, as shown in Figure 41. All I<sup>2</sup>C-compatible devices should recognize a *start condition*.
- The master then generates the SCL pulses and transmits the 7-bit address and the *read/write direction bit* R/W on the SDA line. During all transmissions, the master ensures that data is *valid*. A *valid data condition* requires the SDA line to be stable during the entire high period of the clock pulse (see Figure 42). All devices recognize the address sent by the master and compare it to their internal fixed addresses. Only the slave device with a matching address generates an *acknowledge* (see Figure 43) by pulling the SDA line low during the entire high period of the ninth SCL cycle. On detecting this acknowledge, the master knows that a communication link with a slave has been established.
- The master generates further SCL cycles to either *transmit* data to the slave (R/W bit 1) or *receive* data from the slave (R/W bit 0). In either case, the *receiver* needs to acknowledge the data sent by the *transmitter*. Therefore, an acknowledge signal can either be generated by the master or by the slave, depending on which one is the receiver. The 9-bit valid data sequences, consisting of 8-bit data and 1-bit acknowledge, can continue as long as necessary.
- To signal the end of the data transfer, the master generates a *stop condition* by pulling the SDA line from low to high while the SCL line is high (see Figure 41). This releases the bus and stops the communication link with the addressed slave. All I<sup>2</sup>C-compatible devices must recognize the stop condition. On the receipt of a *stop condition*, all devices know that the bus is released, and they wait for a *start condition* followed by a matching address.

### HS-Mode Protocol

- When the bus is idle, both SDA and SCL lines are pulled high by the pull-up devices.
- The master generates a start condition followed by a valid serial byte containing HS master code 00001XXX. This transmission is made in F/S-mode at no more than 400 kbps. No device is allowed to acknowledge the HS master code, but all devices must recognize it and switch their internal setting to support 3.4 MBPS operation.
- The master then generates a *repeated start condition* (a repeated start condition has the same timing as the start condition). After this repeated start condition, the protocol is the same as F/S-mode, except that transmission speeds up to 3.4 MBPS are allowed. A stop condition ends the HS-mode and switches all the internal settings of the slave devices to support the F/S-mode. Instead of using a stop condition, repeated start conditions should be used to secure the bus in HS-mode.

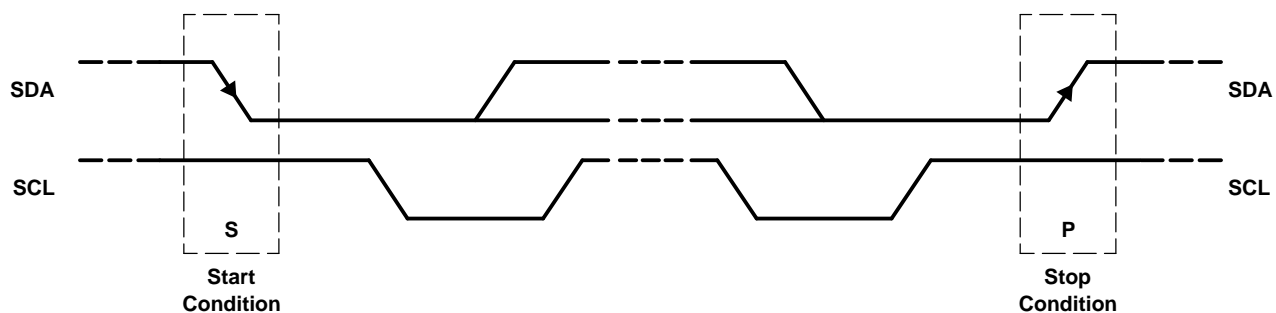

Figure 41. START and STOP Conditions

THEORY OF OPERATION (continued)

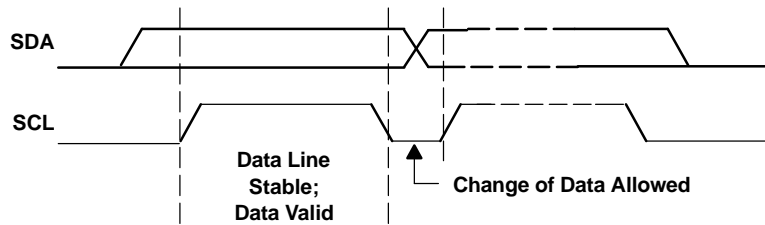

Figure 42. Bit Transfer on the I<sup>2</sup>C Bus

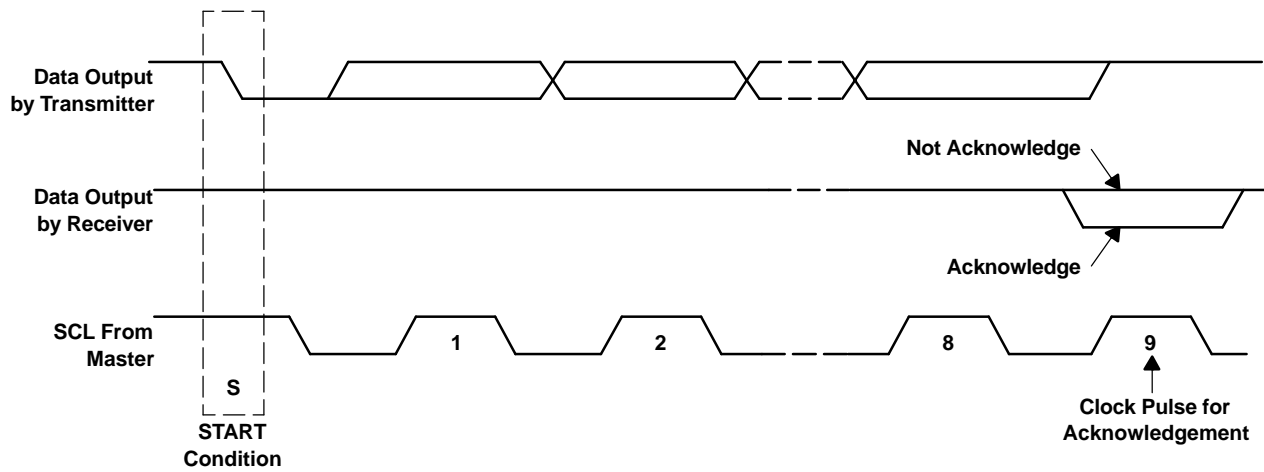

Figure 43. Acknowledge on the I<sup>2</sup>C Bus

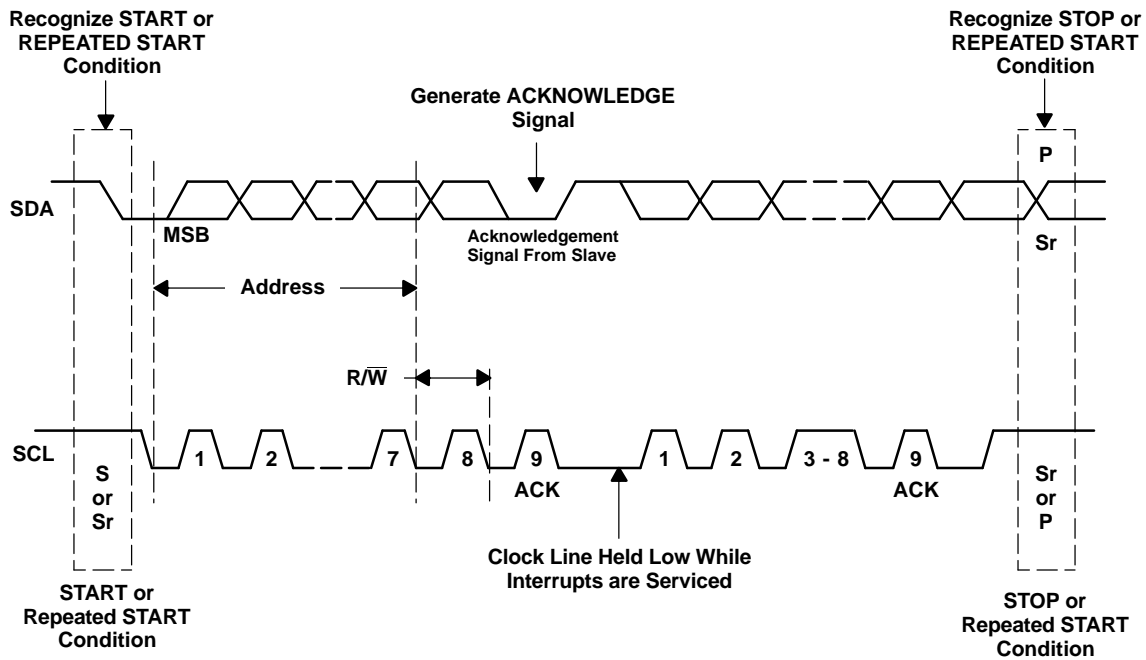

Figure 44. Bus Protocol

## THEORY OF OPERATION (continued)

### DAC6571 I<sup>2</sup>C Update Sequence

The DAC6571 requires a start condition, a valid I<sup>2</sup>C address, a control-MSB byte, and an LSB byte for a single update. After the receipt of each byte, the DAC6571 acknowledges by pulling the SDA line low during the high period of a single clock pulse. A valid I<sup>2</sup>C address selects the DAC6571. The CTRL/MSB byte sets the operational mode of the DAC6571, and the four most significant bits. The DAC6571 then receives the LSB byte containing six least significant data bits. The DAC6571 performs an update on the falling edge of the acknowledge signal that follows the LSB byte.

For the first update, the DAC6571 requires a start condition, a valid I<sup>2</sup>C address, a CTRL/MSB byte, and an LSB byte. For all consecutive updates, the device needs a CTRL/MSB byte, and an LSB byte.

Using the I<sup>2</sup>C high-speed mode ( $f_{scl} = 3.4$  MHz), with the clock running at 3.4 MHz, each 10-bit DAC update other than the first update can be done within 18 clock cycles (CTRL/MSB byte, acknowledge signal, LSB byte, acknowledge signal), at 188.88 kSPS. Using the fast mode ( $f_{scl} = 400$  kHz), and the clock running at 400 kHz, the maximum DAC update rate is limited to 22.22 kSPS. Once a stop condition is received, DAC6571 releases the I<sup>2</sup>C bus and awaits a new start condition.

#### Address Byte

MSB							LSB
1	0	0	1	1	0	A0	0

The address byte is the first byte received following the START condition from the master device. The first six bits (MSBs) of the address are factory-preset to 100110. The next bit of the address is the device select bit A0. The A0 address input can be connected to  $V_{DD}$  or digital GND, or can be actively driven by TTL/CMOS logic levels. The device address is set by the state of this pin during the power-up sequence of the DAC6571. Up to two devices (DAC6571) can be connected to the same I<sup>2</sup>C-bus without requiring additional glue logic.

#### Broadcast Address Byte

MSB							LSB
1	0	0	1	0	0	0	0

Broadcast addressing is also supported by DAC6571. Broadcast addressing can be used for synchronously updating or powering down multiple DAC6571 devices. Using the broadcast address, DAC6571 responds regardless of the state of the address pin A0.

#### Control - Most Significant Byte

The most significant byte (CTRL/MSB[7:0]) consists of two zeros, two power-down bits, and four most significant bits of 10-bit unsigned binary D/A conversion data.

#### Least Significant Byte

The least significant byte (LSB[7:0]) consists of the six least significant bits of the 10-bit unsigned binary D/A conversion data, followed by two don't care bits. DAC6571 updates at the falling edge of the acknowledge signal that follows the LSB[0] bit.

**Standard- and Fast-Mode:**

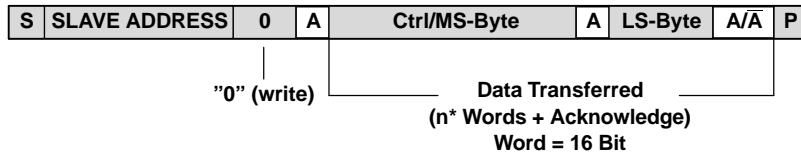

- From Master to DAC6571
- From DAC6571 to Master
- A = Acknowledge (SDA LOW)
- $\bar{A}$  = Not Acknowledge (SDA HIGH)
- S = START Condition
- Sr = Repeated START Condition
- P = STOP Condition

**DAC6571 I<sup>2</sup>C-SLAVE ADDRESS:**

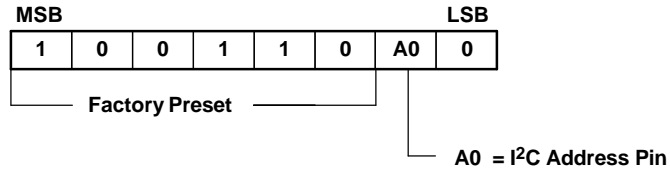

**High-Speed Mode (HS Mode):**

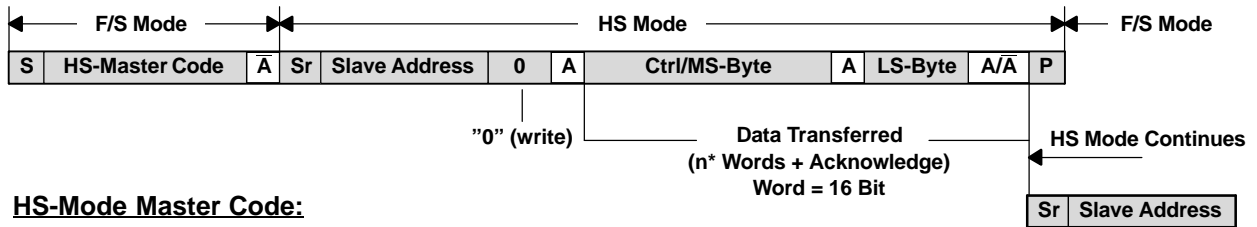

**HS-Mode Master Code:**

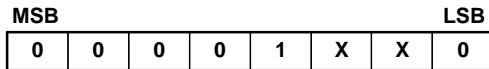

**Ctrl/MS-Byte:**

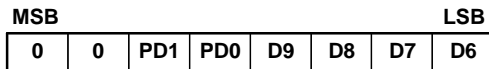

**LS-Byte:**

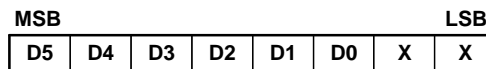

D9 – D0 = Data Bits

**Figure 45. Master Transmitter Addressing DAC6571 as a Slave Receiver With a 7-Bit Address**



## POWER-ON RESET

The DAC6571 contains a power-on reset circuit that controls the output voltage during power up. On power up, the DAC register is filled with zeros and the output voltage is 0 V. It remains at a zero-code output until a valid write sequence is made to the DAC. This configuration is useful in applications where it is important to know the state of the DAC output while it is in the process of powering up.

## POWER-DOWN MODES

The DAC6571 contains four separate modes of operation. These modes are programmable via two bits (PD1 and PD0). Table 1 shows how the state of these bits correspond to the mode of operation.

**Table 1. Modes of Operation for the DAC6571**

PD1	PD0	OPERATING MODE
0	0	Normal Operation
0	1	1 kΩ to AGND, PWD
1	0	100 kΩ to AGND, PWD
1	1	High Impedance, PWD

When both bits are set to zero, the device works normally with normal power consumption of 150 μA at 5 V. However, for the three power-down modes, the supply current falls to 200 nA at 5 V (50 nA at 3 V). Not only does the supply current fall, but the output stage is also internally switched from the output of the amplifier to a resistor network of known values. This has the advantage that the output impedance of the device is known while in power-down mode. There are three different options: The output is connected internally to AGND through a 1-kΩ resistor, a 100-kΩ resistor, or it is left open-circuited (high impedance). The output stage is illustrated in Figure 46.

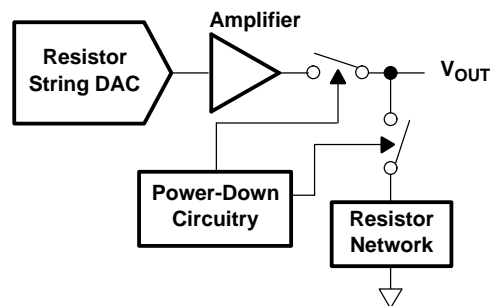

**Figure 46. Output Stage During Power Down**

All linear circuitry is shut down when the power-down mode is activated. However, the contents of the DAC register are unaffected when in power-down. The time required to exit power down is typically 2.5 μs for  $V_{DD} = 5$  V and 5 μs for  $V_{DD} = 3$  V. See the *Typical Characteristics* section for more information.

## CURRENT CONSUMPTION

The DAC6571 typically consumes 150 μA at  $V_{DD} = 5$  V and 120 μA at  $V_{DD} = 3$  V. Additional current consumption can occur due to the digital inputs if  $V_{IH} \ll V_{DD}$ . For the most efficient power operation, CMOS logic levels are recommended at the digital inputs to the DAC. In power-down mode, typical current consumption is 200 nA.

## DRIVING RESISTIVE AND CAPACITIVE LOADS

The DAC6571 output stage is capable of driving loads of up to 1000 pF while remaining stable. Within the offset and gain error margins, the DAC6571 can operate rail-to-rail when driving a capacitive load. When the outputs of the DAC are driven to the positive rail under resistive loading, the PMOS transistor of each Class-AB output stage can enter into the linear region. When this occurs, the added IR voltage drop deteriorates the linearity performance of the DAC. This degradation may occur approximately within the top 20 mV of the DAC digital input-to-voltage output transfer characteristic.

## OUTPUT VOLTAGE STABILITY

The DAC6571 exhibits excellent temperature stability of 5 ppm/°C typical output voltage drift over the specified temperature range of the device. This enables the output voltage to stay within a  $\pm 25\text{-}\mu\text{V}$  window for a  $\pm 1^\circ\text{C}$  ambient temperature change. Combined with good dc noise performance and true 10-bit differential linearity, the DAC6571 becomes a perfect choice for closed-loop control applications.

## APPLICATIONS

### USING REF02 AS A POWER SUPPLY FOR THE DAC6571

Due to the extremely low supply current required by the DAC6571, a possible configuration is to use a REF02 +5-V precision voltage reference to supply the required voltage to the DAC6571 supply input as well as the reference input, as shown in Figure 47. This is especially useful if the power supply is quite noisy or if the system supply voltages are at some value other than 5 V. The REF02 outputs a steady supply voltage for the DAC6571. If the REF02 is used, the current it needs to supply to the DAC6571 is 140  $\mu\text{A}$  typical. When a DAC output is loaded, the REF02 also needs to supply the current to the load. The total typical current required (with a 5-mW load on a given DAC output) is:  $140\ \mu\text{A} + (5\ \text{mW}/5\ \text{V}) = 1.14\ \text{mA}$ .

The load regulation of the REF02 is typically  $(0.005\% \times V_{\text{DD}})/\text{mA}$ , which results in an error of 0.285 mV for the 1.14-mA current drawn from it. This corresponds to a 0.05 LSB error for a 0-V to 5-V output range.

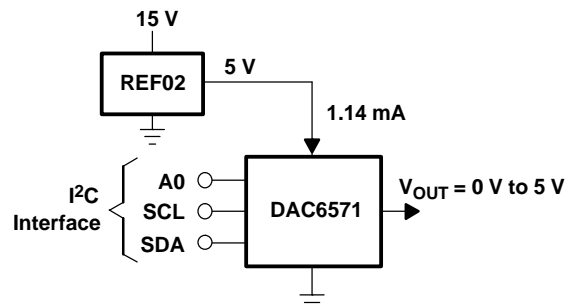

Figure 47. REF02 as Power Supply to DAC6571

## LAYOUT

A precision analog component requires careful layout, adequate bypassing, and clean, well-regulated power supplies.

The power applied to  $V_{\text{DD}}$  should be well-regulated and low-noise. Switching power supplies and dc/dc converters often have high-frequency glitches or spikes riding on the output voltage. In addition, digital components can create similar high-frequency spikes as their internal logic switches states. This noise can easily couple into the DAC output voltage through various paths between the power connections and analog output.

As with the GND connection,  $V_{\text{DD}}$  should be connected to a +5-V power supply plane or trace that is separate from the connection for digital logic until they are connected at the power entry point. In addition, the 1- $\mu\text{F}$  to 10- $\mu\text{F}$  and 0.1- $\mu\text{F}$  bypass capacitors are strongly recommended. In some situations, additional bypassing may be required, such as a 100- $\mu\text{F}$  electrolytic capacitor or even a Pi filter made up of inductors and capacitors—also designed to essentially low-pass filter the +5-V supply, removing the high-frequency noise.

**PACKAGING INFORMATION**

Orderable Device	Status (1)	Package Type	Package Drawing	Pins	Package Qty	Eco Plan (2)	Lead finish/ Ball material (6)	MSL Peak Temp (3)	Op Temp (°C)	Device Marking (4/5)	Samples
DAC6571IDBVR	ACTIVE	SOT-23	DBV	6	3000	RoHS & Green	NIPDAU	Level-1-260C-UNLIM	-40 to 105	D671	<a href="#">Samples</a>
DAC6571IDBVT	ACTIVE	SOT-23	DBV	6	250	RoHS & Green	NIPDAU	Level-1-260C-UNLIM	-40 to 105	D671	<a href="#">Samples</a>

(1) The marketing status values are defined as follows:

**ACTIVE:** Product device recommended for new designs.

**LIFEBUY:** TI has announced that the device will be discontinued, and a lifetime-buy period is in effect.

**NRND:** Not recommended for new designs. Device is in production to support existing customers, but TI does not recommend using this part in a new design.

**PREVIEW:** Device has been announced but is not in production. Samples may or may not be available.

**OBSELETE:** TI has discontinued the production of the device.

(2) **RoHS:** TI defines "RoHS" to mean semiconductor products that are compliant with the current EU RoHS requirements for all 10 RoHS substances, including the requirement that RoHS substance do not exceed 0.1% by weight in homogeneous materials. Where designed to be soldered at high temperatures, "RoHS" products are suitable for use in specified lead-free processes. TI may reference these types of products as "Pb-Free".

**RoHS Exempt:** TI defines "RoHS Exempt" to mean products that contain lead but are compliant with EU RoHS pursuant to a specific EU RoHS exemption.

**Green:** TI defines "Green" to mean the content of Chlorine (Cl) and Bromine (Br) based flame retardants meet JS709B low halogen requirements of <=1000ppm threshold. Antimony trioxide based flame retardants must also meet the <=1000ppm threshold requirement.

(3) MSL, Peak Temp. - The Moisture Sensitivity Level rating according to the JEDEC industry standard classifications, and peak solder temperature.

(4) There may be additional marking, which relates to the logo, the lot trace code information, or the environmental category on the device.

(5) Multiple Device Markings will be inside parentheses. Only one Device Marking contained in parentheses and separated by a "~" will appear on a device. If a line is indented then it is a continuation of the previous line and the two combined represent the entire Device Marking for that device.

(6) Lead finish/Ball material - Orderable Devices may have multiple material finish options. Finish options are separated by a vertical ruled line. Lead finish/Ball material values may wrap to two lines if the finish value exceeds the maximum column width.

**Important Information and Disclaimer:**The information provided on this page represents TI's knowledge and belief as of the date that it is provided. TI bases its knowledge and belief on information provided by third parties, and makes no representation or warranty as to the accuracy of such information. Efforts are underway to better integrate information from third parties. TI has taken and continues to take reasonable steps to provide representative and accurate information but may not have conducted destructive testing or chemical analysis on incoming materials and chemicals. TI and TI suppliers consider certain information to be proprietary, and thus CAS numbers and other limited information may not be available for release.

In no event shall TI's liability arising out of such information exceed the total purchase price of the TI part(s) at issue in this document sold by TI to Customer on an annual basis.

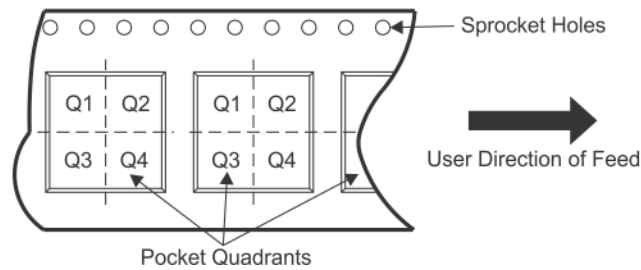

**TAPE AND REEL INFORMATION**

**QUADRANT ASSIGNMENTS FOR PIN 1 ORIENTATION IN TAPE**

\*All dimensions are nominal

Device	Package Type	Package Drawing	Pins	SPQ	Reel Diameter (mm)	Reel Width W1 (mm)	A0 (mm)	B0 (mm)	K0 (mm)	P1 (mm)	W (mm)	Pin1 Quadrant
DAC6571IDBVR	SOT-23	DBV	6	3000	178.0	9.0	3.23	3.17	1.37	4.0	8.0	Q3
DAC6571IDBVT	SOT-23	DBV	6	250	178.0	9.0	3.23	3.17	1.37	4.0	8.0	Q3

**TAPE AND REEL BOX DIMENSIONS**

\*All dimensions are nominal

Device	Package Type	Package Drawing	Pins	SPQ	Length (mm)	Width (mm)	Height (mm)
DAC6571IDBVR	SOT-23	DBV	6	3000	180.0	180.0	18.0
DAC6571IDBVT	SOT-23	DBV	6	250	180.0	180.0	18.0

# DBV0006A



## PACKAGE OUTLINE

SOT-23 - 1.45 mm max height

SMALL OUTLINE TRANSISTOR

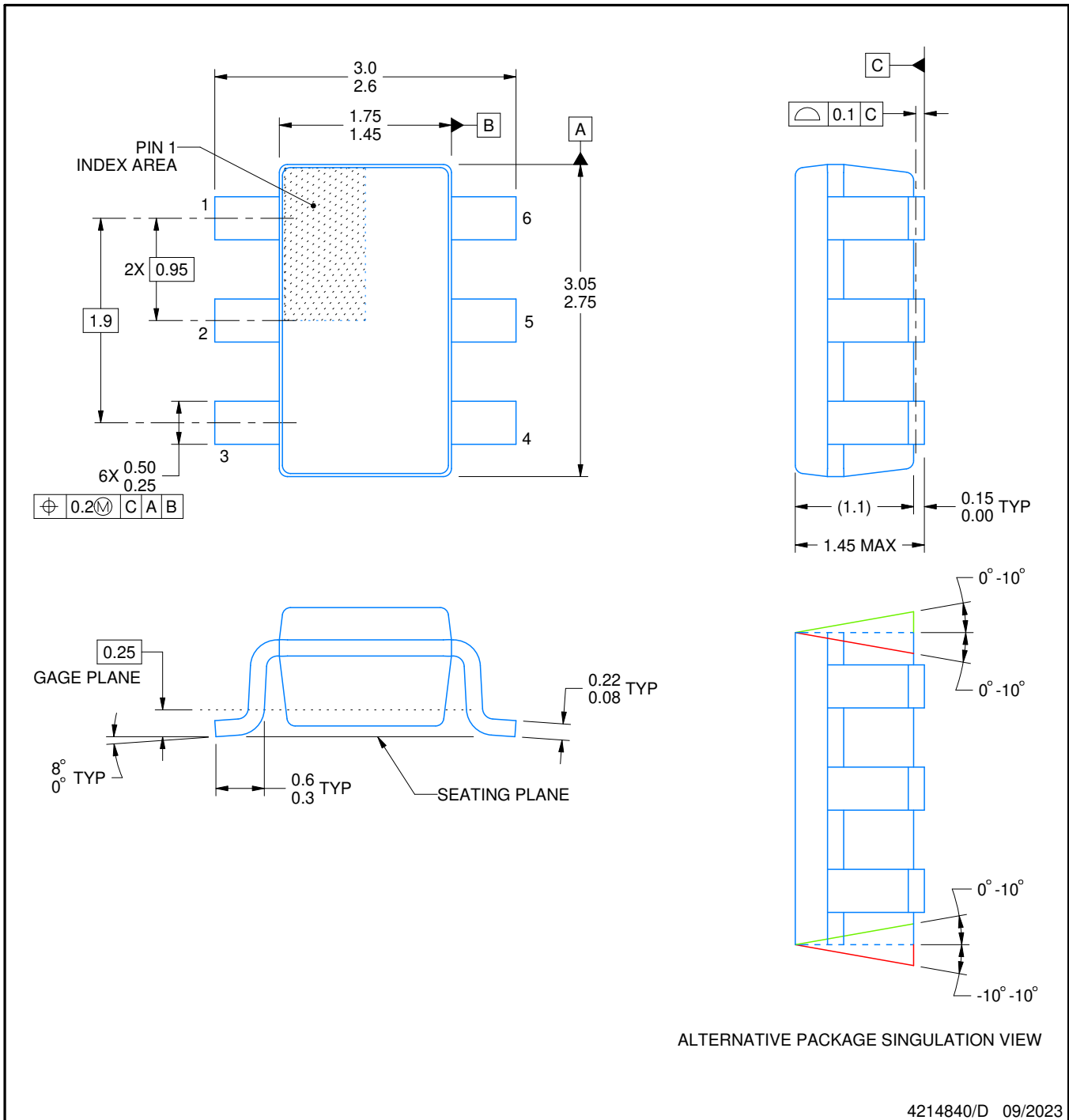

### NOTES:

1. All linear dimensions are in millimeters. Any dimensions in parenthesis are for reference only. Dimensioning and tolerancing per ASME Y14.5M.
2. This drawing is subject to change without notice.
3. Body dimensions do not include mold flash or protrusion. Mold flash and protrusion shall not exceed 0.25 per side.
4. Leads 1,2,3 may be wider than leads 4,5,6 for package orientation.
5. Reference JEDEC MO-178.

4214840/D 09/2023

# EXAMPLE BOARD LAYOUT

DBV0006A

SOT-23 - 1.45 mm max height

SMALL OUTLINE TRANSISTOR

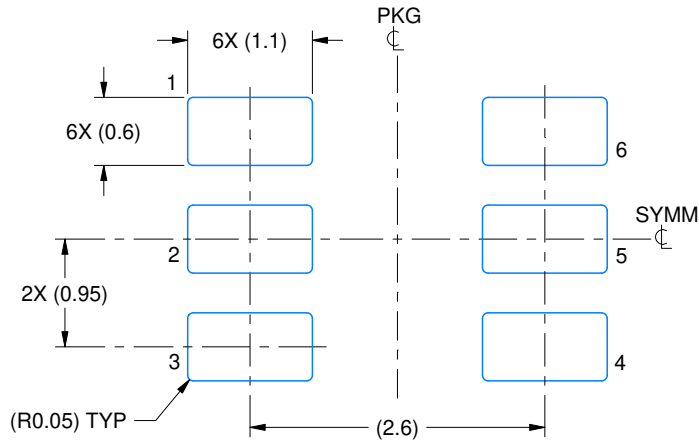

LAND PATTERN EXAMPLE  
EXPOSED METAL SHOWN  
SCALE:15X

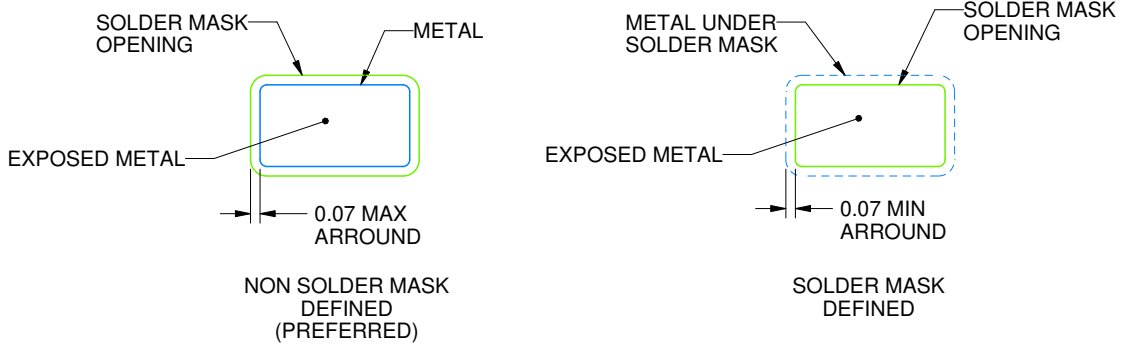

SOLDER MASK DETAILS

4214840/D 09/2023

NOTES: (continued)

6. Publication IPC-7351 may have alternate designs.

7. Solder mask tolerances between and around signal pads can vary based on board fabrication site.



# EXAMPLE STENCIL DESIGN

DBV0006A

SOT-23 - 1.45 mm max height

SMALL OUTLINE TRANSISTOR

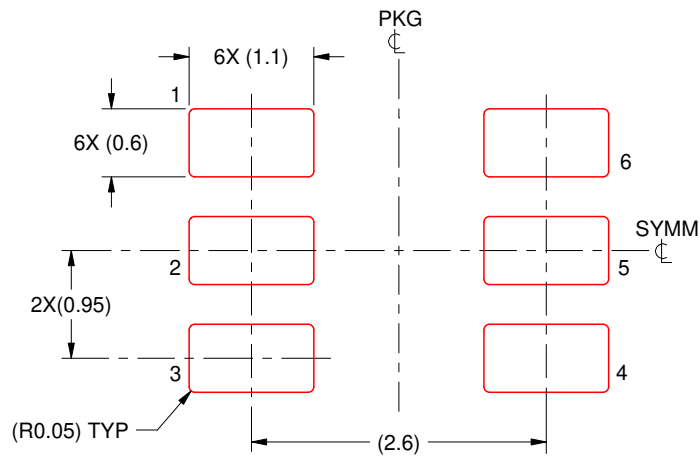

SOLDER PASTE EXAMPLE  
BASED ON 0.125 mm THICK STENCIL  
SCALE:15X

4214840/D 09/2023

NOTES: (continued)

8. Laser cutting apertures with trapezoidal walls and rounded corners may offer better paste release. IPC-7525 may have alternate design recommendations.
9. Board assembly site may have different recommendations for stencil design.

## IMPORTANT NOTICE AND DISCLAIMER

TI PROVIDES TECHNICAL AND RELIABILITY DATA (INCLUDING DATA SHEETS), DESIGN RESOURCES (INCLUDING REFERENCE DESIGNS), APPLICATION OR OTHER DESIGN ADVICE, WEB TOOLS, SAFETY INFORMATION, AND OTHER RESOURCES "AS IS" AND WITH ALL FAULTS, AND DISCLAIMS ALL WARRANTIES, EXPRESS AND IMPLIED, INCLUDING WITHOUT LIMITATION ANY IMPLIED WARRANTIES OF MERCHANTABILITY, FITNESS FOR A PARTICULAR PURPOSE OR NON-INFRINGEMENT OF THIRD PARTY INTELLECTUAL PROPERTY RIGHTS.

These resources are intended for skilled developers designing with TI products. You are solely responsible for (1) selecting the appropriate TI products for your application, (2) designing, validating and testing your application, and (3) ensuring your application meets applicable standards, and any other safety, security, regulatory or other requirements.

These resources are subject to change without notice. TI grants you permission to use these resources only for development of an application that uses the TI products described in the resource. Other reproduction and display of these resources is prohibited. No license is granted to any other TI intellectual property right or to any third party intellectual property right. TI disclaims responsibility for, and you will fully indemnify TI and its representatives against, any claims, damages, costs, losses, and liabilities arising out of your use of these resources.

TI's products are provided subject to [TI's Terms of Sale](#) or other applicable terms available either on [ti.com](https://www.ti.com) or provided in conjunction with such TI products. TI's provision of these resources does not expand or otherwise alter TI's applicable warranties or warranty disclaimers for TI products.

TI objects to and rejects any additional or different terms you may have proposed.

Mailing Address: Texas Instruments, Post Office Box 655303, Dallas, Texas 75265  
Copyright © 2023, Texas Instruments Incorporated