



specifications

CRI	Voltage	Ambient Temp (F)	Color Temp	Material	IP Rating	Efficacy	Gross Weight	Beam Angle	Dimensions	Warranty	Case QTY
80	100-277 V	-40° - 140°	5000K	copper free aluminum housing	IP 66	140 LM / W	40.8 lbs	120°	46.1" X 5.5" X 5.22"	6 years	1 pcs

select your fixture

Part Number	Color Temp	Consumption	Lumen Output
GI-EPI-C250-G4	5000K	60W	8,400

add your accessories*

Accessories Part Number	Description
1.) GI-ACC-EPJB	Junction Box
2.) GI-ACC-EPSSP	Straight Swing Pipe

optional*

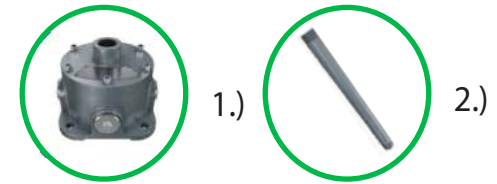

Distribution Diagram

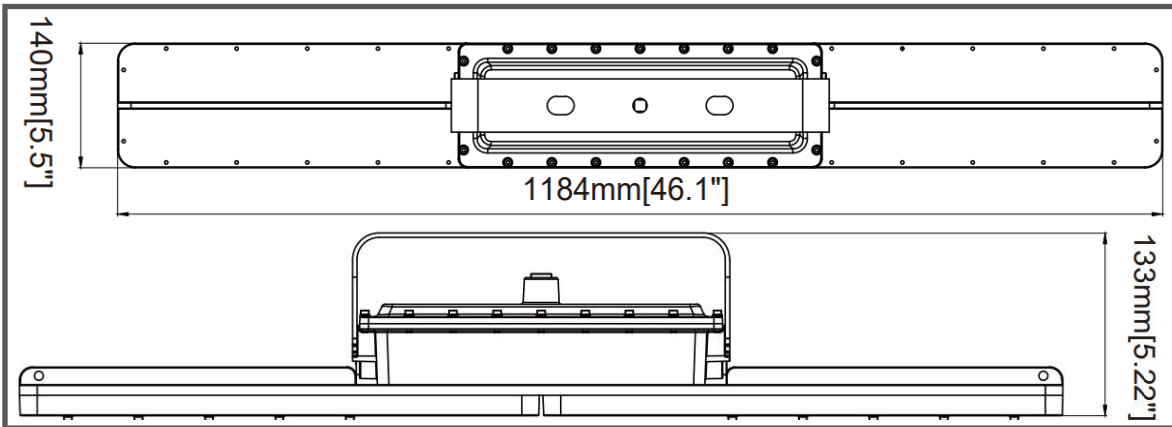

- Features**
- Rated for high temperatures, humidity, dust and vapor locations
 - Built for a variety of purposes such as spot light, tunnel light, and general illumination in hazardous locations
 - Heavy duty and high impact resistance
 - Various installation options for particular applications
 - Dimmable and battery back-up function available



	Center Beam fc	Beam Width	
4ft	683fc	11ft	11ft
8ft	170fc	21ft	22ft
12ft	73fc	32ft	33ft
16ft	39fc	43ft	45ft
20ft	26fc	53ft	56ft

■ Vert, Spread; 120°
■ Horiz, Spread; 120°

Not all product variations listed on this page may be DLC qualified. Visit www.designlights.org/search to confirm qualification.

