

# **TPS54418EVM-375 4-A, SWIFT™ Regulator Evaluation Module**

### Contents

1	Introduction .....	2
2	Test Setup and Results .....	4
3	Board Layout .....	9
4	Schematic and Bill of Materials.....	14

### List of Figures

1	TPS54418EVM-375 Efficiency .....	5
2	TPS54418EVM-375 Low Current Efficiency .....	5
3	TPS54418EVM-375 Load Regulation.....	6
4	TPS54418EVM-375 Line Regulation.....	6
5	TPS54418EVM-375 Transient Response .....	7
6	TPS54418EVM-375 Loop Response .....	7
7	TPS54418EVM-375 Output Ripple .....	8
8	TPS54418EVM-375 Input Ripple .....	8
9	TPS54418EVM-375 Start-Up Relative to $V_{IN}$ .....	9
10	TPS54418EVM-375 Start-up Relative to Enable .....	9
11	TPS54418EVM-375 Top-Side Layout .....	10
12	TPS54418EVM-375 Bottom-Side Layout .....	11
13	TPS54418EVM-375 Layout 2.....	12
14	TPS54418EVM-375 Layout 3.....	13
15	TPS54418EVM-375 Top-Side Assembly.....	14
16	TPS54418EVM-375 Schematic .....	15

### List of Tables

1	Input Voltage and Output Current Summary .....	2
2	TPS54418EVM-375 Performance Specification Summary.....	2
3	Output Voltages Available .....	3
4	EVM Connectors and Test Points .....	4
5	TPS54418EVM-375 Bill of Materials.....	16

## 1 Introduction

This user's guide contains background information for the TPS54418 as well as support documentation for the TPS54418EVM-375 evaluation module (HPA375). Also included are the performance specifications, the schematic, and the bill of materials for the TPS54418EVM-375.

### 1.1 Background

The TPS54418 dc/dc converter is designed to provide up to a 4 A output from an input voltage source of 2.95 V to 6 V. Rated input voltage and output current range for the evaluation module are given in [Table 1](#). This evaluation module is designed to demonstrate the small printed-circuit-board areas that may be achieved when designing with the TPS54418 regulator. The switching frequency is externally set at a nominal 1000 kHz. The high-side and low-side MOSFETs are incorporated inside the TPS54418 package along with the gate drive circuitry. The low drain-to-source on resistance of the MOSFETs allow the TPS54418 to achieve high efficiencies and helps keep the junction temperature low at high output currents. The compensation components are external to the integrated circuit (IC), and an external divider allows for an adjustable output voltage. Additionally, the TPS54418 provides adjustable slow start and undervoltage lockout inputs. The absolute maximum input voltage is 7 V for the TPS54418EVM-375.

**Table 1. Input Voltage and Output Current Summary**

EVM	INPUT VOLTAGE RANGE	OUTPUT CURRENT RANGE
TPS54418EVM-375	V <sub>IN</sub> = 3 V to 6 V (V <sub>IN</sub> start = 3.1 V)	0 A to 4 A

### 1.2 Performance Specification Summary

A summary of the TPS54418EVM-375 performance specifications is provided in [Table 2](#). Specifications are given for an input voltage of V<sub>IN</sub> = 3.3 V and an output voltage of 1.8 V, unless otherwise specified. The TPS54418EVM-375 is designed and tested for V<sub>IN</sub> = 3 V to 6 V. The ambient temperature is 25°C for all measurements, unless otherwise noted.

**Table 2. TPS54418EVM-375 Performance Specification Summary**

SPECIFICATION	TEST CONDITIONS	MIN	TYP	MAX	UNIT
V <sub>IN</sub> operating voltage range		3	3.3	6	V
V <sub>IN</sub> start voltage			3.1		V
V <sub>IN</sub> stop voltage			2.8		V
Output voltage set point			1.8		V
Output current range	V <sub>IN</sub> = 3 V to 6 V	0		4	A
Line regulation	I <sub>O</sub> = 2 A, V <sub>IN</sub> = 3 V to 6 V		±0.05%		
Load regulation	V <sub>IN</sub> = 3.3 V, I <sub>O</sub> = 0 A to 4 A		±0.08%		
Load transient response	I <sub>O</sub> = 1 A to 3 A	Voltage change	–30		mV
		Recovery time	300		μs
	I <sub>O</sub> = 3 A to 1 A	Voltage change	30		mV
		Recovery time	300		μs
Loop bandwidth	V <sub>IN</sub> = 3.3 V, I <sub>O</sub> = 4 A		35		kHz
Phase margin	V <sub>IN</sub> = 3.3 V, I <sub>O</sub> = 4 A		74		°
Input ripple voltage	I <sub>O</sub> = 4 A		150		mV <sub>PP</sub>
Output ripple voltage	I <sub>O</sub> = 4 A		5		mV <sub>PP</sub>
Output rise time			6		ms
Operating frequency			1000		kHz
Maximum efficiency	TPS54418EVM-375, V <sub>IN</sub> = 3.3 V, I <sub>O</sub> = 0.5 A		93.5%		

### 1.3 Modifications

These evaluation modules are designed to provide access to the features of the TPS54418. Some modifications can be made to this module.

#### 1.3.1 Output Voltage Set Point

The voltage divider R6 and R7 is used to set the output voltage. To change the output voltage of the EVM, it is necessary to change the value of resistor R7. Changing the value of R7 can change the output voltage above 0.8 V. The value of R7 for a specific output voltage can be calculated using [Equation 1](#).

$$R7 = 100 \text{ k}\Omega \times \frac{0.8 \text{ V}}{V_{\text{OUT}} - 0.8 \text{ V}} \quad (1)$$

[Table 3](#) lists the R7 values for some common output voltages. Note that  $V_{\text{IN}}$  must be in a range so that the minimum on-time is greater than 80 ns, and the maximum duty cycle is less than 92%. The values given in [Table 3](#) are standard values, not the exact value calculated using [Equation 1](#).

**Table 3. Output Voltages Available**

Output Voltage (V)	R7 Value (k $\Omega$ )
1.0	402
1.2	200
1.5	115
1.8	80.6
2.5	47.5

#### 1.3.2 Slow Start Time

The slow start time can be adjusted by changing the value of C7. Use [Equation 2](#) to calculate the required value of C7 for a desired slow start time

$$C7(\text{nF}) = \frac{T_{\text{SS}}(\text{mS}) \times I_{\text{SS}}(\mu\text{A})}{V_{\text{ref}}(\text{V})} \quad (2)$$

C7 is set to 0.01  $\mu\text{F}$  on the EVM for a default slowstart time of 4 msec.

#### 1.3.3 Adjustable UVLO

The under voltage lock out (UVLO) can be adjusted externally using R1 and R2. The EVM is set for a start voltage of 3.1 V and a stop voltage of 2.8 V using  $R1 = 48.8 \text{ k}\Omega$  and  $R2 = 32.4 \text{ k}\Omega$ . Use [Equation 3](#) and [Equation 4](#) to calculate required resistor values for different start and stop voltages.

$$R1 = \frac{0.944 \cdot V_{\text{START}} - V_{\text{STOP}}}{2.59 \times 10^{-6}} \quad (3)$$

$$R2 = \frac{1.18 \cdot R1}{V_{\text{STOP}} - 1.18 + R1 \cdot 3.2 \times 10^{-6}} \quad (4)$$

## 2 Test Setup and Results

This section describes how to properly connect, set up, and use the TPS54418EVM-375 evaluation module. The section also includes test results typical for the evaluation module and covers efficiency, output voltage regulation, load transients, loop response, output ripple, input ripple, and start-up.

### 2.1 Input / Output Connections

The TPS54418EVM-375 is provided with input/output connectors and test points as shown in [Table 4](#). A power supply capable of supplying 3 A must be connected to J1 through a pair of 20 AWG wires. The load must be connected to J4 through a pair of 20 AWG wires. The maximum load current capability must be at least 4 A to use the full capability of this EVM. Wire lengths must be minimized to reduce losses in the wires. Test-point TP1 provides a place to monitor the  $V_{IN}$  input voltages with TP2 providing a convenient ground reference. TP6 is used to monitor the output voltage with TP7 as the ground reference.

**Table 4. EVM Connectors and Test Points**

Reference Designator	Function
J1	$V_{IN}$ (see <a href="#">Table 1</a> for $V_{IN}$ range).
J2	2-pin header for enable. Connect EN to ground to disable, open to enable.
J3	2-pin header for to allow pull up of PWRGD to $V_{IN}$ .
J4	$V_{OUT}$ , 1.8 V at 4 A maximum.
TP1	$V_{IN}$ test point at $V_{IN}$ connector.
TP2	GND test point at $V_{IN}$ .
TP3	PH test point
TP4	Slow start monitor test point.
TP5	Test point between voltage divider network and output. Used for loop response measurements.
TP6	Output voltage test point at OUT connector.
TP7	GND test point at OUT connector.

## 2.2 Efficiency

The efficiency of this EVM peaks at a load current of about 0.5 A – 1 A and then decreases as the load current increases towards full load. Figure 1 shows the efficiency for the TPS54418EVM-375 at an ambient temperature of 25°C.

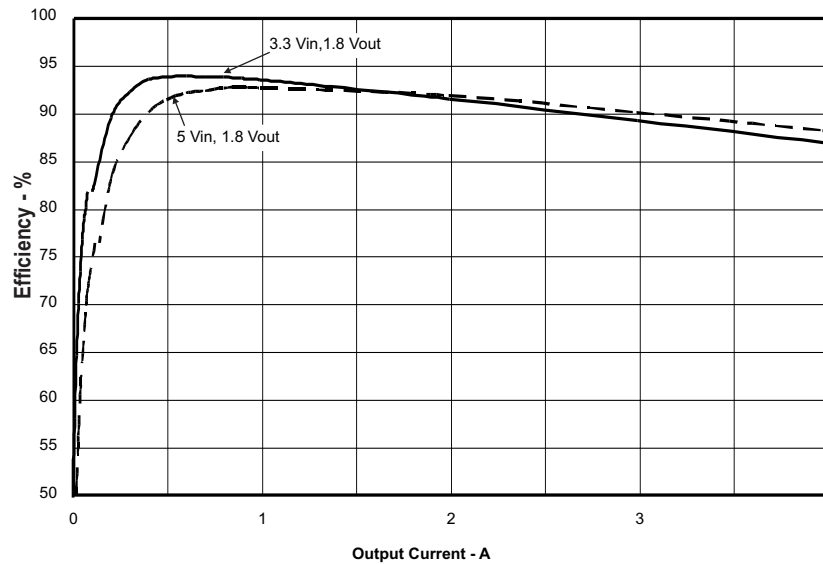

Figure 1. TPS54418EVM-375 Efficiency

Figure 2 shows the efficiency for the TPS54418EVM-375 at lower output currents between 0.02 A and 0.20 A at an ambient temperature of 25°C.

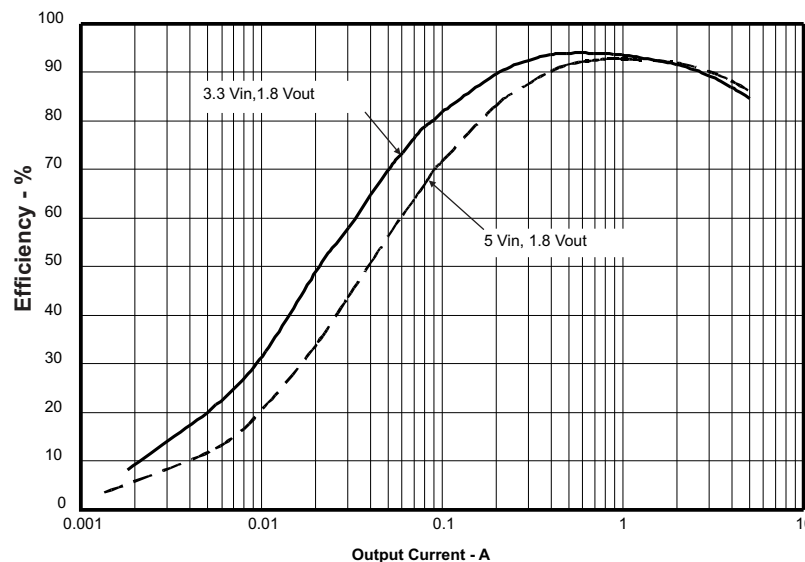

Figure 2. TPS54418EVM-375 Low Current Efficiency

The efficiency may be lower at higher ambient temperatures, due to temperature variation in the drain-to-source resistance of the internal MOSFET.

### 2.3 Output Voltage Load Regulation

Figure 3 shows the load regulation for the TPS54418EVM-375.

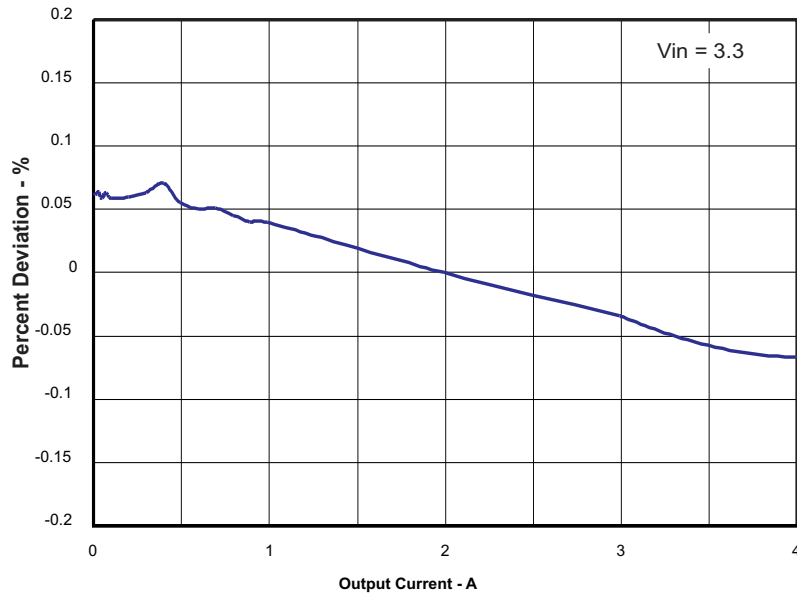

Figure 3. TPS54418EVM-375 Load Regulation

Measurements are given for an ambient temperature of 25°C.

### 2.4 Output Voltage Line Regulation

Figure 4 shows the line regulation for the TPS54418EVM-375.

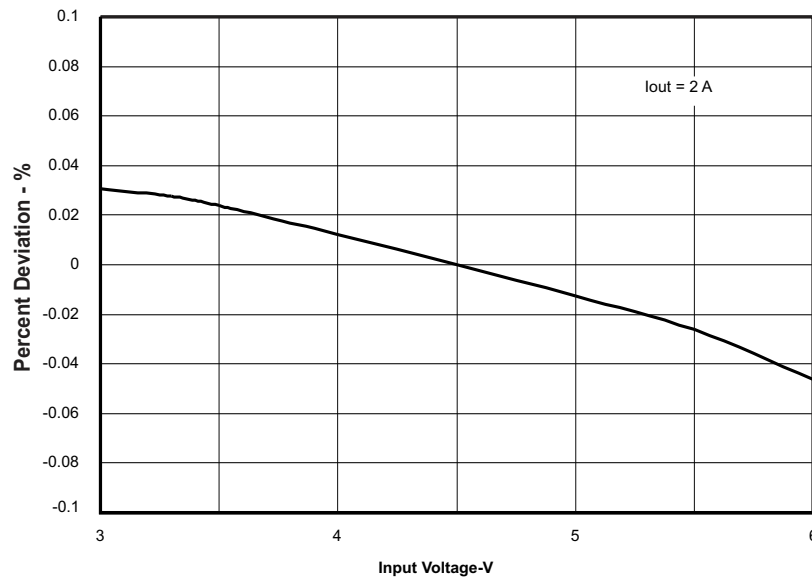
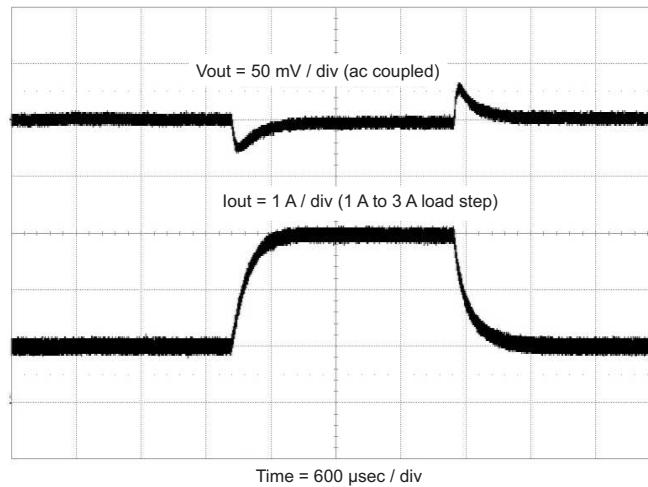

Figure 4. TPS54418EVM-375 Line Regulation

## 2.5 Load Transients

Figure 5 shows the TPS54318EVM-375 response to load transients. The current step is from 25% to 75% of maximum rated load at 3.3 V input. Total peak-to-peak voltage variation is as shown, including ripple and noise on the output.



**Figure 5. TPS54418EVM-375 Transient Response**

## 2.6 Loop Characteristics

Figure 6 shows the TPS54418EVM-375 loop-response characteristics. Gain and phase plots are shown for  $V_{IN}$  voltage of 3.3 V. Load current for the measurement is 4 A.

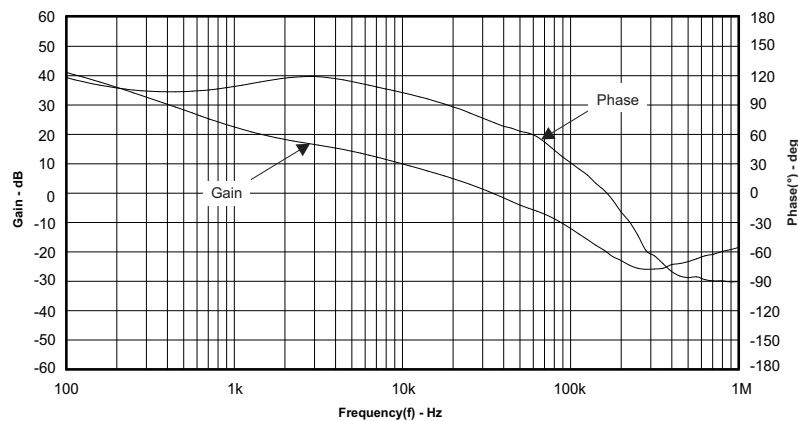

**Figure 6. TPS54418EVM-375 Loop Response**

## 2.7 Output Voltage Ripple

Figure 7 shows the TPS54418EVM-375 output voltage ripple. The output current is the rated full load of 4A and  $V_{IN} = 3.3$  V. The ripple voltage is measured directly across the output capacitors.

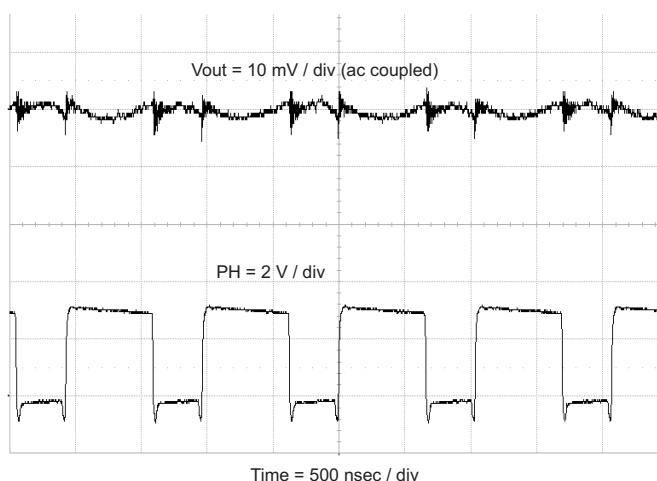

**Figure 7. TPS54418EVM-375 Output Ripple**

## 2.8 Input Voltage Ripple

Figure 8 shows the TPS54418EVM-375 input voltage ripple. The output current is the rated full load of 4A and  $V_{IN} = 3.3$  V. The ripple voltage is measured directly across the input capacitors.

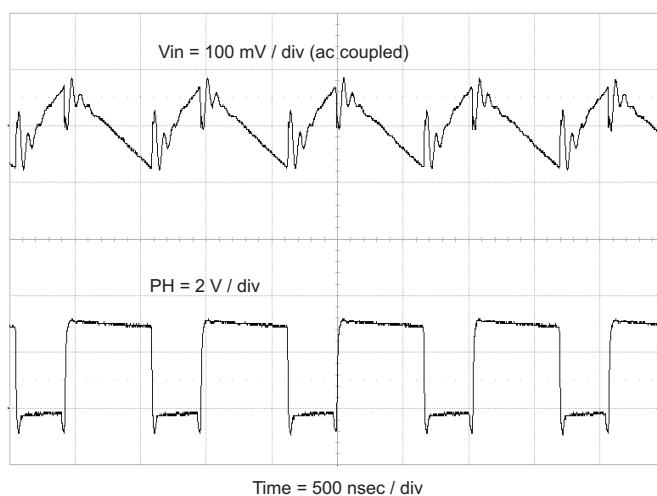

**Figure 8. TPS54418EVM-375 Input Ripple**



## 2.9 Powering Up

Figure 9 and Figure 10 show the start-up waveforms for the TPS54418EVM-375. In Figure 9, the output voltage ramps up as soon as the input voltage reaches the UVLO threshold as set by the  $R_1$  and  $R_2$  resistor divider network. In Figure 10, the input voltage is initially applied and the output is inhibited by using a jumper at J2 to tie EN to GND. When the jumper is removed, EN is released. When the EN voltage reaches the enable-threshold voltage, the start-up sequence begins and the output voltage ramps up to the externally set value of 1.8 V. The input voltage for these plots is 5 V and the load is 1 $\Omega$ .

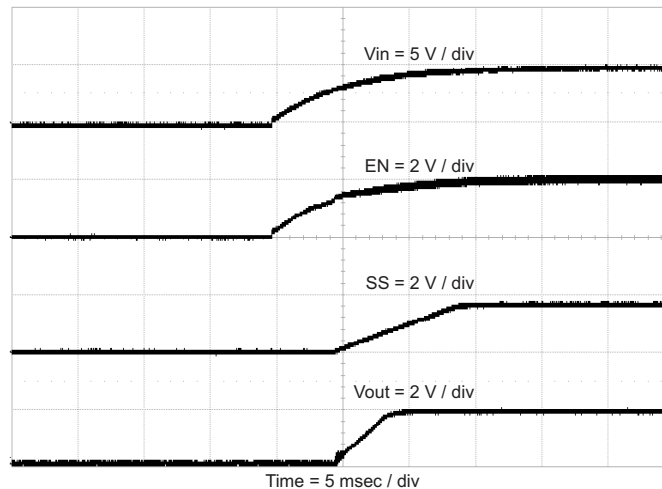

Figure 9. TPS54418EVM-375 Start-Up Relative to  $V_{IN}$

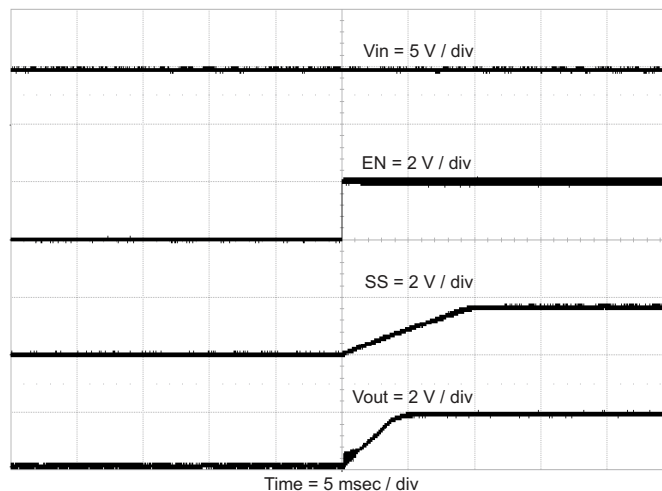

Figure 10. TPS54418EVM-375 Start-up Relative to Enable

## 3 Board Layout

This section provides a description of the TPS54418EVM-375, board layout, and layer illustrations.

### 3.1 Layout

Figure 11 through Figure 15 shows the board layout for the TPS54418EVM-375. The topside layer of the EVM is laid out in a manner typical of a user application. The top, bottom and internal layers are 2-oz. copper.

The top layer contains the main power traces for  $V_{IN}$ ,  $V_{OUT}$ , and  $V_{PHASE}$ . Also on the top layer are

connections for the remaining pins of the TPS54418 and a large area filled with ground. The bottom and internal layers contain ground planes only. The top-side ground areas are connected to the bottom and internal ground planes with multiple vias placed around the board including four vias directly under the TPS54418 device to provide a thermal path from the top-side ground area to the bottom-side and internal ground planes.

The input decoupling capacitors (C2, and C3) and bootstrap capacitor (C6) are all located as close to the IC as possible. In addition, the voltage set-point resistor divider components are also kept close to the IC. The voltage divider network ties to the output voltage at the point of regulation, the copper  $V_{OUT}$  trace near the output connector J4. For the TPS54418, an additional input bulk capacitor may be required, depending on the EVM connection to the input supply.

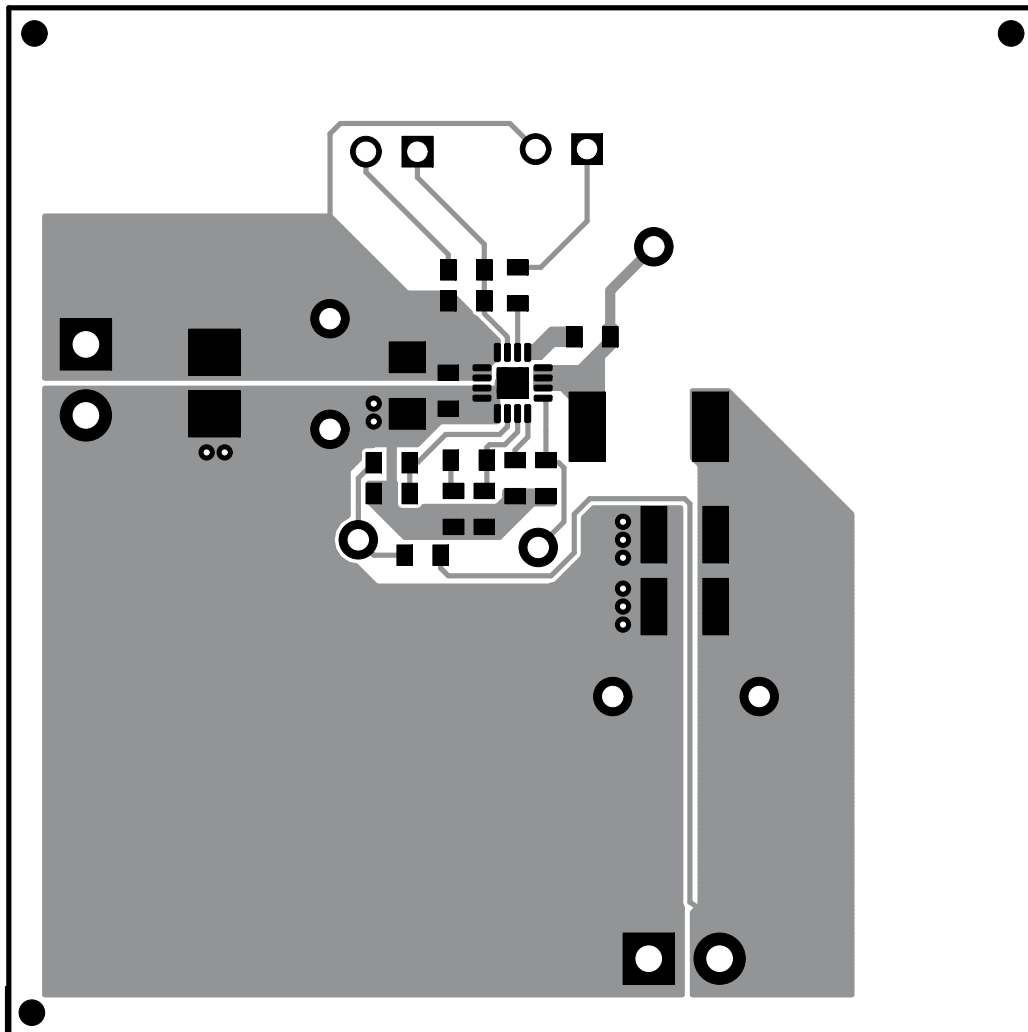

Figure 11. TPS54418EVM-375 Top-Side Layout

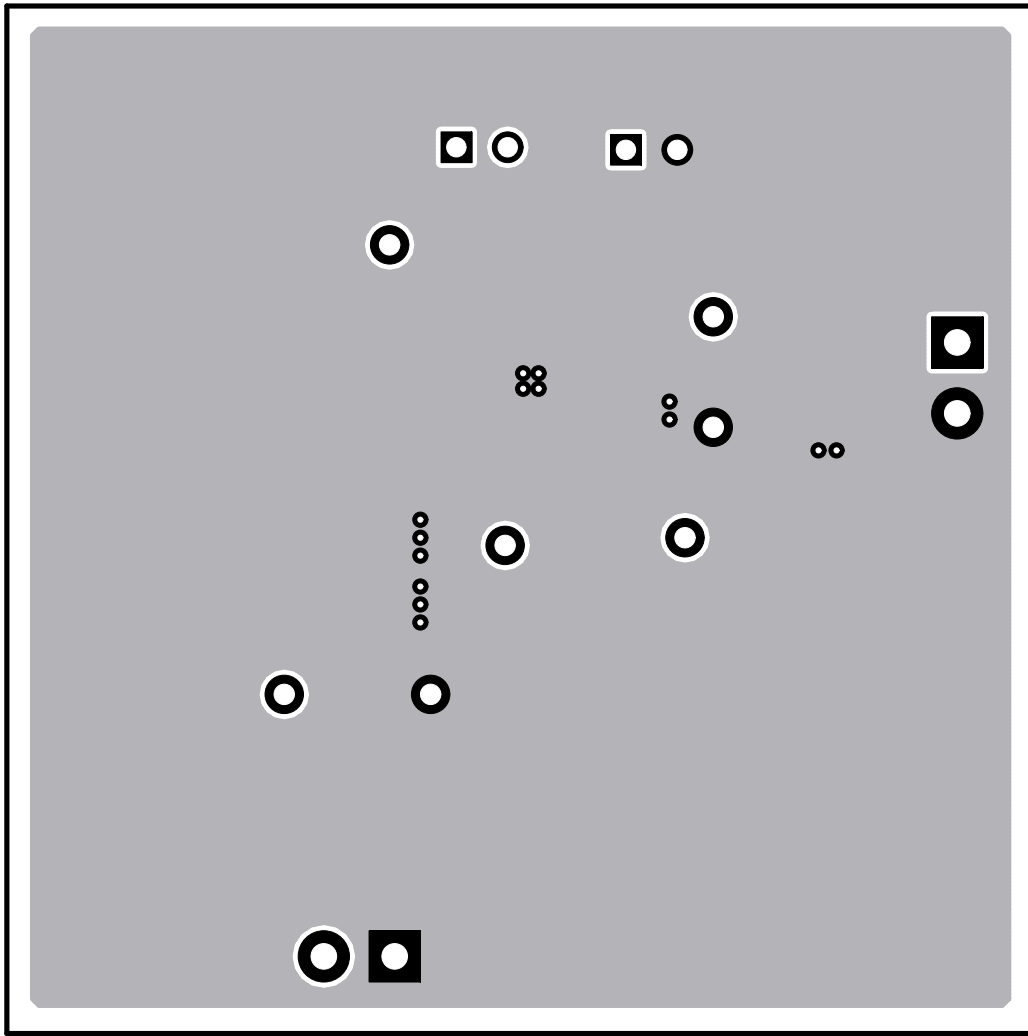

Figure 12. TPS54418EVM-375 Bottom-Side Layout

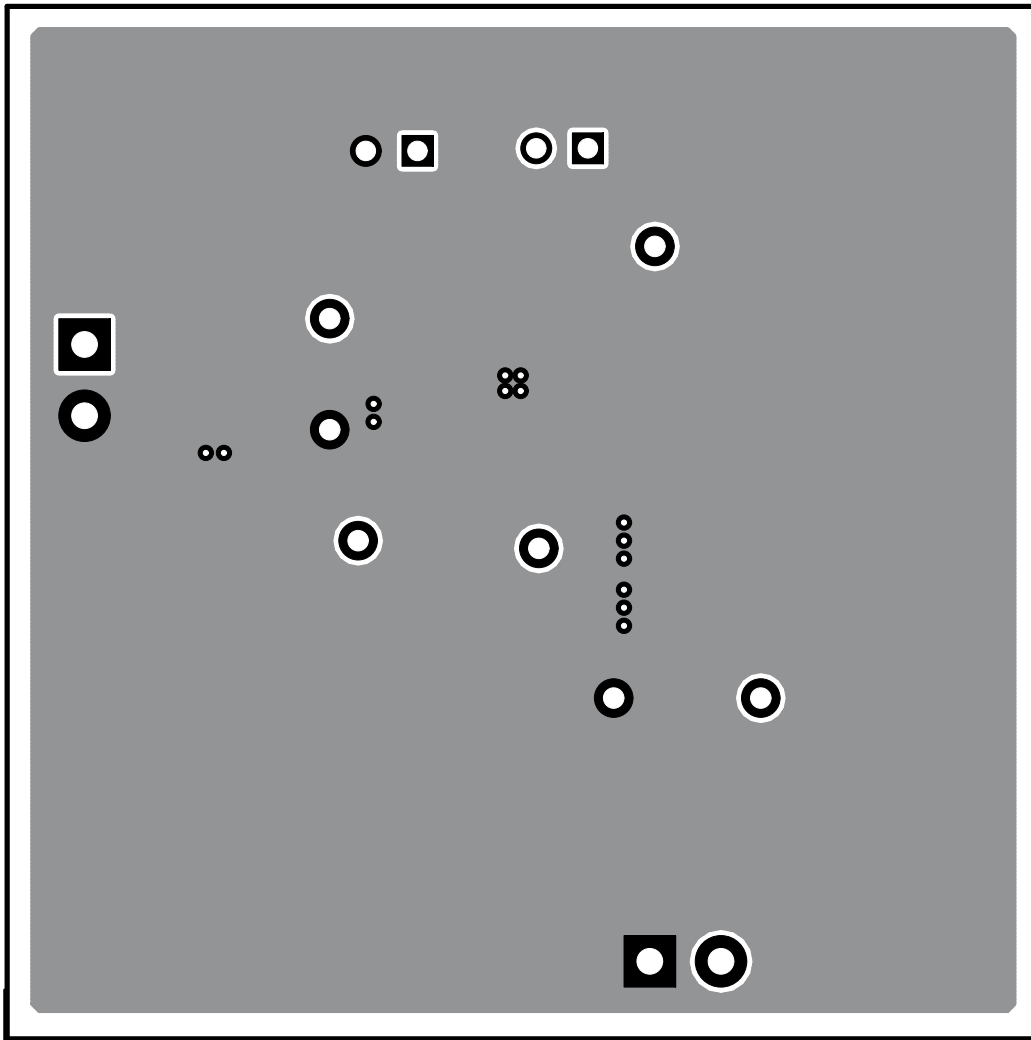

Figure 13. TPS54418EVM-375 Layout 2

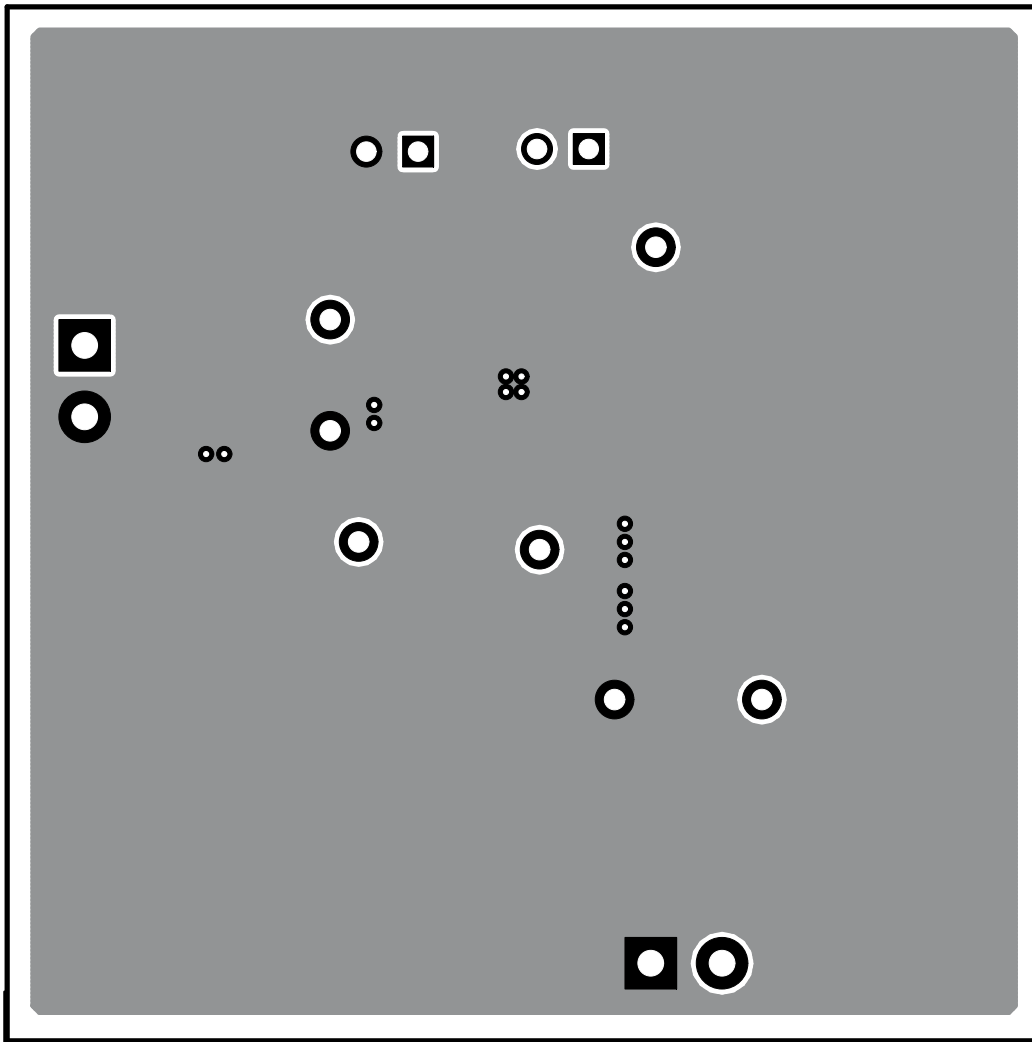

Figure 14. TPS54418EVM-375 Layout 3

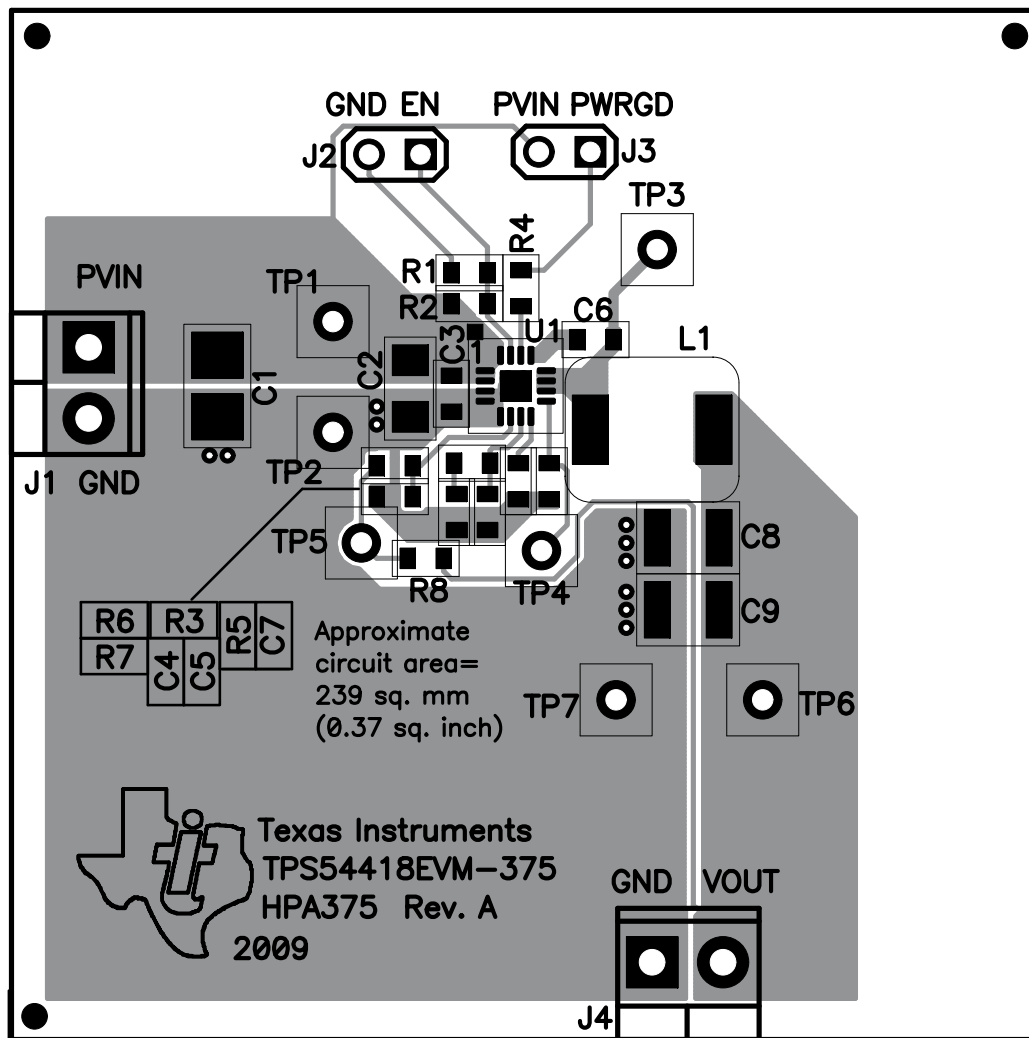

Figure 15. TPS54418EVM-375 Top-Side Assembly

### 3.2 Estimated Circuit Area

The estimated printed circuit board area for the components used in this design is 0.37 in<sup>2</sup> (239 mm<sup>2</sup>). This area does not include test point or connectors.

## 4 Schematic and Bill of Materials

This section presents the TPS54418EVM-375 schematic and bill of materials.

### 4.1 Schematic

Figure 16 is the schematic for the TPS54418EVM-375.

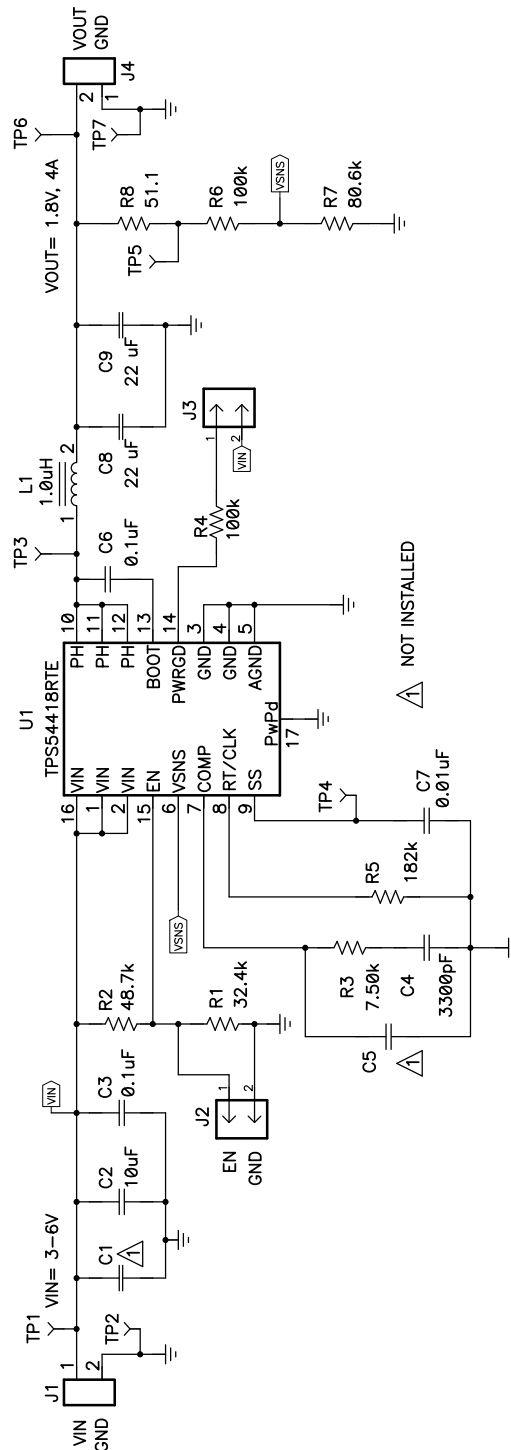

Figure 16. TPS54418EVM-375 Schematic

## 4.2 Bill of Materials

Table 5 presents the bill of materials for the TPS54418EVM-375.

**Table 5. TPS54418EVM-375 Bill of Materials**

Count	RefDes	Value	Description	Size	Part Number	MFR
0	C1	Open	Capacitor, Ceramic, xxV, X7R, yy%	Multi sizes	Engineering Only	Std
1	C2	10 $\mu$ F	Capacitor, Ceramic, 10V, X5R, 20%	1206	Std	Std
1	C3, C6	0.1 $\mu$ F	Capacitor, Ceramic, 25V, X5R, 10%	0603	Std	Std
1	C4	3300pF	Capacitor, Ceramic, 50V, X7R, 10%	0603	Std	Std
0	C5	Open	Capacitor, Ceramic, xxV, temp, yy%	0603	Std	Std
1	C7	0.01 $\mu$ F	Capacitor, Ceramic, 16V, X7R, 15%	0603	Std	Std
2	C8, C9	22 $\mu$ F	Capacitor, Ceramic, 10V, X5R, 20%	1210	Std	Std
2	J1, J4	ED555/2DS	Terminal Block, 2-pin, 6-A, 3.5mm	0.27 x 0.25 inch	ED555/2DS	OST
2	J2, J3	PEC02SAAN	Header, Male 2-pin, 100mil spacing	0.100 inch x 2	PEC02SAAN	Sullins
1	L1	1.0 $\mu$ H	Inductor, SMT, 9.1A, 10-milliohm	0.255 x 0.270 inch	FDV0630-1R0M	TOKO
1	R1	32.4k	Resistor, Chip, 1/16W, 1%	0603	Std	Std
1	R2	48.7k	Resistor, Chip, 1/16W, 1%	0603	Std	Std
1	R3	7.50k	Resistor, Chip, 1/16W, 1%	0603	Std	Std
2	R4, R6	100k	Resistor, Chip, 1/16W, 1%	0603	Std	Std
1	R5	182k	Resistor, Chip, 1/16W, 1%	0603	Std	Std
1	R7	80.6k	Resistor, Chip, 1/16W, 1%	0603	Std	Std
1	R8	51.1	Resistor, Chip, 1/16W, 1%	0603	Std	Std
5	TP1, TP3, TP4, TP5, TP6	5000	Test Point, Red, Thru Hole Color Keyed	0.100 x 0.100 inch	5000	Keystone
2	TP2, TP7	5001	Test Point, Black, Thru Hole Color Keyed	0.100 x 0.100 inch	5001	Keystone
1	U1	TPS54418RTE	IC, DC-DC Converter, 3-6 V, 4A	QFN-16	TPS54418RTE	TI
2	–		Shunt, 100-mil, Black	0.100	929950-00	3M
1	–		PCB, 2.5" x 2.5" x 0.062"		HPA375	Any

Notes 1. These assemblies are ESD sensitive, ESD precautions shall be observed.  
 2. These assemblies must be clean and free from flux and all contaminants. Use of no clean flux is not acceptable.  
 3. These assemblies must comply with workmanship standards IPC-A-610 Class 2.  
 4. Ref designators marked with an asterisk (\*\*\*) cannot be substituted. All other components can be substituted with equivalent MFG's components.



## EVALUATION BOARD/KIT IMPORTANT NOTICE

Texas Instruments (TI) provides the enclosed product(s) under the following conditions:

This evaluation board/kit is intended for use for **ENGINEERING DEVELOPMENT, DEMONSTRATION, OR EVALUATION PURPOSES ONLY** and is not considered by TI to be a finished end-product fit for general consumer use. Persons handling the product(s) must have electronics training and observe good engineering practice standards. As such, the goods being provided are not intended to be complete in terms of required design-, marketing-, and/or manufacturing-related protective considerations, including product safety and environmental measures typically found in end products that incorporate such semiconductor components or circuit boards. This evaluation board/kit does not fall within the scope of the European Union directives regarding electromagnetic compatibility, restricted substances (RoHS), recycling (WEEE), FCC, CE or UL, and therefore may not meet the technical requirements of these directives or other related directives.

Should this evaluation board/kit not meet the specifications indicated in the User's Guide, the board/kit may be returned within 30 days from the date of delivery for a full refund. **THE FOREGOING WARRANTY IS THE EXCLUSIVE WARRANTY MADE BY SELLER TO BUYER AND IS IN LIEU OF ALL OTHER WARRANTIES, EXPRESSED, IMPLIED, OR STATUTORY, INCLUDING ANY WARRANTY OF MERCHANTABILITY OR FITNESS FOR ANY PARTICULAR PURPOSE.**

The user assumes all responsibility and liability for proper and safe handling of the goods. Further, the user indemnifies TI from all claims arising from the handling or use of the goods. Due to the open construction of the product, it is the user's responsibility to take any and all appropriate precautions with regard to electrostatic discharge.

**EXCEPT TO THE EXTENT OF THE INDEMNITY SET FORTH ABOVE, NEITHER PARTY SHALL BE LIABLE TO THE OTHER FOR ANY INDIRECT, SPECIAL, INCIDENTAL, OR CONSEQUENTIAL DAMAGES.**

TI currently deals with a variety of customers for products, and therefore our arrangement with the user **is not exclusive.**

TI assumes **no liability for applications assistance, customer product design, software performance, or infringement of patents or services described herein.**

Please read the User's Guide and, specifically, the Warnings and Restrictions notice in the User's Guide prior to handling the product. This notice contains important safety information about temperatures and voltages. For additional information on TI's environmental and/or safety programs, please contact the TI application engineer or visit [www.ti.com/esh](http://www.ti.com/esh).

No license is granted under any patent right or other intellectual property right of TI covering or relating to any machine, process, or combination in which such TI products or services might be or are used.

### FCC Warning

This evaluation board/kit is intended for use for **ENGINEERING DEVELOPMENT, DEMONSTRATION, OR EVALUATION PURPOSES ONLY** and is not considered by TI to be a finished end-product fit for general consumer use. It generates, uses, and can radiate radio frequency energy and has not been tested for compliance with the limits of computing devices pursuant to part 15 of FCC rules, which are designed to provide reasonable protection against radio frequency interference. Operation of this equipment in other environments may cause interference with radio communications, in which case the user at his own expense will be required to take whatever measures may be required to correct this interference.

### EVM WARNINGS AND RESTRICTIONS

It is important to operate this EVM within the input voltage range and the output current range specified in Table 1.

Exceeding the specified input range may cause unexpected operation and/or irreversible damage to the EVM. If there are questions concerning the input range, please contact a TI field representative prior to connecting the input power.

Applying loads outside of the specified output range may result in unintended operation and/or possible permanent damage to the EVM. Please consult the EVM User's Guide prior to connecting any load to the EVM output. If there is uncertainty as to the load specification, please contact a TI field representative.

During normal operation, some circuit components may have case temperatures greater than 55°C. The EVM is designed to operate properly with certain components above 60°C as long as the input and output ranges are maintained. These components include but are not limited to linear regulators, switching transistors, pass transistors, and current sense resistors. These types of devices can be identified using the EVM schematic located in the EVM User's Guide. When placing measurement probes near these devices during operation, please be aware that these devices may be very warm to the touch.

Mailing Address: Texas Instruments, Post Office Box 655303, Dallas, Texas 75265  
Copyright = 2006, Texas Instruments Incorporated

## IMPORTANT NOTICE

Texas Instruments Incorporated and its subsidiaries (TI) reserve the right to make corrections, modifications, enhancements, improvements, and other changes to its products and services at any time and to discontinue any product or service without notice. Customers should obtain the latest relevant information before placing orders and should verify that such information is current and complete. All products are sold subject to TI's terms and conditions of sale supplied at the time of order acknowledgment.

TI warrants performance of its hardware products to the specifications applicable at the time of sale in accordance with TI's standard warranty. Testing and other quality control techniques are used to the extent TI deems necessary to support this warranty. Except where mandated by government requirements, testing of all parameters of each product is not necessarily performed.

TI assumes no liability for applications assistance or customer product design. Customers are responsible for their products and applications using TI components. To minimize the risks associated with customer products and applications, customers should provide adequate design and operating safeguards.

TI does not warrant or represent that any license, either express or implied, is granted under any TI patent right, copyright, mask work right, or other TI intellectual property right relating to any combination, machine, or process in which TI products or services are used. Information published by TI regarding third-party products or services does not constitute a license from TI to use such products or services or a warranty or endorsement thereof. Use of such information may require a license from a third party under the patents or other intellectual property of the third party, or a license from TI under the patents or other intellectual property of TI.

Reproduction of TI information in TI data books or data sheets is permissible only if reproduction is without alteration and is accompanied by all associated warranties, conditions, limitations, and notices. Reproduction of this information with alteration is an unfair and deceptive business practice. TI is not responsible or liable for such altered documentation. Information of third parties may be subject to additional restrictions.

Resale of TI products or services with statements different from or beyond the parameters stated by TI for that product or service voids all express and any implied warranties for the associated TI product or service and is an unfair and deceptive business practice. TI is not responsible or liable for any such statements.

TI products are not authorized for use in safety-critical applications (such as life support) where a failure of the TI product would reasonably be expected to cause severe personal injury or death, unless officers of the parties have executed an agreement specifically governing such use. Buyers represent that they have all necessary expertise in the safety and regulatory ramifications of their applications, and acknowledge and agree that they are solely responsible for all legal, regulatory and safety-related requirements concerning their products and any use of TI products in such safety-critical applications, notwithstanding any applications-related information or support that may be provided by TI. Further, Buyers must fully indemnify TI and its representatives against any damages arising out of the use of TI products in such safety-critical applications.

TI products are neither designed nor intended for use in military/aerospace applications or environments unless the TI products are specifically designated by TI as military-grade or "enhanced plastic." Only products designated by TI as military-grade meet military specifications. Buyers acknowledge and agree that any such use of TI products which TI has not designated as military-grade is solely at the Buyer's risk, and that they are solely responsible for compliance with all legal and regulatory requirements in connection with such use.

TI products are neither designed nor intended for use in automotive applications or environments unless the specific TI products are designated by TI as compliant with ISO/TS 16949 requirements. Buyers acknowledge and agree that, if they use any non-designated products in automotive applications, TI will not be responsible for any failure to meet such requirements.

Following are URLs where you can obtain information on other Texas Instruments products and application solutions:

### Products

Amplifiers	<a href="http://amplifier.ti.com">amplifier.ti.com</a>
Data Converters	<a href="http://dataconverter.ti.com">dataconverter.ti.com</a>
DLP® Products	<a href="http://www.dlp.com">www.dlp.com</a>
DSP	<a href="http://dsp.ti.com">dsp.ti.com</a>
Clocks and Timers	<a href="http://www.ti.com/clocks">www.ti.com/clocks</a>
Interface	<a href="http://interface.ti.com">interface.ti.com</a>
Logic	<a href="http://logic.ti.com">logic.ti.com</a>
Power Mgmt	<a href="http://power.ti.com">power.ti.com</a>
Microcontrollers	<a href="http://microcontroller.ti.com">microcontroller.ti.com</a>
RFID	<a href="http://www.ti-rfid.com">www.ti-rfid.com</a>
RF/IF and ZigBee® Solutions	<a href="http://www.ti.com/lprf">www.ti.com/lprf</a>

### Applications

Audio	<a href="http://www.ti.com/audio">www.ti.com/audio</a>
Automotive	<a href="http://www.ti.com/automotive">www.ti.com/automotive</a>
Broadband	<a href="http://www.ti.com/broadband">www.ti.com/broadband</a>
Digital Control	<a href="http://www.ti.com/digitalcontrol">www.ti.com/digitalcontrol</a>
Medical	<a href="http://www.ti.com/medical">www.ti.com/medical</a>
Military	<a href="http://www.ti.com/military">www.ti.com/military</a>
Optical Networking	<a href="http://www.ti.com/opticalnetwork">www.ti.com/opticalnetwork</a>
Security	<a href="http://www.ti.com/security">www.ti.com/security</a>
Telephony	<a href="http://www.ti.com/telephony">www.ti.com/telephony</a>
Video & Imaging	<a href="http://www.ti.com/video">www.ti.com/video</a>
Wireless	<a href="http://www.ti.com/wireless">www.ti.com/wireless</a>

Mailing Address: Texas Instruments, Post Office Box 655303, Dallas, Texas 75265  
Copyright © 2009, Texas Instruments Incorporated