

NON-ISOLATED DC/DC CONVERTERS

4.5 Vdc - 14 Vdc Input, 0.7 Vdc – 2 Vdc /50 A Outputs



Jul. 17 2015

Bel Power Inc., a subsidiary of Bel Fuse Inc.

SLIN-50E1AL

RoHS Compliant

Rev.E

Features

- Wide Input Voltage Range
- Monotonic Start-up
- Negative Remote On/Off
- True Differential Remote Sense
- Tunable Loop™ (a registered trademark of Lineage Power Systems) to Optimize Dynamic output voltage response
- Compliant to IPC-9592 (September 2008), Category 2, Class II
- Parallel Operation With Active Current Sharing
- Compliant to RoHS EU Directive 2002/95/EC
- UL* 60950 Recognized, CSA† C22.2 No. 60950-1-07 Certified
- VDE‡ 0805 (EN60950-1 2nd edition) Licensed
- Output Voltage Sequencing
- Over Temperature Protection
- Output Over Current Protection

Applications

- Distributed power architectures
- Intermediate bus voltage applications
- Telecommunications equipment
- Industrial applications



Description

The SLIN-50E1AL power modules are non-isolated dc/dc converters that can deliver up to 50 A of output current. These modules operate over a wide range of input voltage ($V_{IN} = 4.5 \text{ Vdc} - 14 \text{ Vdc}$) and provide a precisely regulated output voltage from 0.7 Vdc to 2.0 Vdc, programmable via an external resistor. Features include remote On/Off, adjustable output voltage, over current and over temperature protection, output voltage sequencing and paralleling. A new feature, the Tunable Loop™, allows the user to optimize the dynamic response of the converter to match the load with reduced amount of output capacitance leading to savings on cost and PWB area.

Part Selection

Output Voltage	Input Voltage	Max. Output Current	Typical Efficiency	Model Number Active Low
0.7 Vdc - 2 Vdc	4.5 Vdc - 14 Vdc	50 A	87%	SLIN-50E1AL

- Notes:** 1. Add "R" suffix at the end of the model number to indicate tape and reel packaging (Standard).
2. Add "G" suffix at the end of the model number to indicate tray packaging (Option).

Ordering Part Number

S LIN - 50 E 1A L x
1 2 3 4 5 6 7

- 1---Surface mount
- 2---Series code
- 3---Output current (50A)
- 4--- Wide input voltage range (4.5-14V)
- 5--- Wide output voltage range (0.7-2V)
- 6--- Enable, active low
- 7---Package, "G" for Tray Packaging, "R" for Reel Packaging

NON-ISOLATED DC/DC CONVERTERS

4.5 Vdc - 14 Vdc Input, 0.7 Vdc – 2 Vdc /50 A Outputs



Jul. 17 2015

Bel Power Inc., a subsidiary of Bel Fuse Inc.

Absolute Maximum Ratings

Parameter	Min	Typ	Max	Unit	Notes
Continuous Input Voltage	-0.3	-	14	V	
Sequencing Pin Voltage	-0.3	-	4	V	
Operating Ambient Temperature	-40	-	85	°C	
Storage Temperature	-55	-	125	°C	
Altitude	-	-	2000	m	

Note: Stresses in excess of the absolute maximum ratings can cause permanent damage to the device. These are absolute stress ratings only, functional operation of the device is not implied at these or any other conditions in excess of those given in the operations sections of the data sheet. Exposure to absolute maximum ratings for extended periods can adversely affect the device reliability.

Input Specifications

Parameter	Min	Typ	Max	Unit	Notes
Operating Input Voltage	4.5	-	14	V	
Input Current (full load)	-	-	26	A	$V_{IN} = V_{IN,min}$ to $V_{IN,max}$, $I_O = I_{O,max}$
Input Current (no load)	-	73.4	-	mA	$V_O = 0.7V$, $V_{IN} = V_{IN,mon}$, $I_O = 0$ module enabled
	-	136	-	mA	$V_O = 1.8V$, $V_{IN} = V_{IN,mon}$, $I_O = 0$ module enabled
Input Stand-by Current	-	1.3	-	mA	$V_{IN} = V_{IN,mon}$, module disabled
Input Reflected Ripple Current (pk-pk)	-	-	73	mA	5Hz to 20MHz, 1 μ H source impedance; $V_{IN,min}$ to $V_{IN,max}$, $I_O = I_{O,max}$
I ² t Inrush Current Transient	-	-	1	A ² s	
Input Ripple Rejection (120Hz)	-	50	-	dB	
Turn-on Threshold	-	4.26	-	V	
Turn-off Threshold	-	4.04	-	V	
Hysteresis	-	0.22	-	V	

CAUTION: This converter is not internally fused. An input line fuse must be used in application.

This power module can be used in a wide variety of applications, ranging from simple standalone operation to an integrated part of sophisticated power architecture. To preserve maximum flexibility, internal fusing is not included; however, to achieve maximum safety and system protection, always use an input line fuse. The safety agencies require a surface mount, fast acting fuse with a maximum rating of 30A. Based on the information provided in this data sheet on inrush energy and maximum dc input current, the same type of fuse with a lower rating can be used. Refer to the fuse manufacturer's data sheet for further information.

Note: Unless otherwise indicated, specifications apply over all operating input voltage, resistive load, and temperature conditions.

NON-ISOLATED DC/DC CONVERTERS

4.5 Vdc - 14 Vdc Input, 0.7 Vdc – 2 Vdc /50 A Outputs



Jul. 17 2015

Bel Power Inc., a subsidiary of Bel Fuse Inc.

Output Specifications

Parameter	Min	Typ	Max	Unit	Notes
Output Voltage Set Point	-1.0	-	+1.0	%Vo,set	$V_{IN}=V_{IN,nom}$, $I_O=I_{O,nom}$, $T_{ref}=25^{\circ}C$.
Output Voltage	-2.0	-	+2.0	%Vo,set	Over all operating input voltage, resistive load, and temperature conditions until end of life
Adjustment Range	0.7	-	2.0	V	selected by an external resistor
Remote Sense Range	-	-	0.5	V	
Load Regulation	-	-	8	mV	$I_O=I_{O,min}$ to $I_{O,max}$
Line Regulation	-	-	5	mV	$V_{IN}=V_{IN,min}$ to $V_{IN,max}$
Temperature Regulation (-40°C to 85°C)	-	-	8	mV	$T_{ref}=T_{A,min}$ to $T_{A,max}$
Ripple and Noise (pk-pk)	-	-	50	mV	5Hz to 20MHz BW, $V_{IN}=V_{IN,nom}$ and $I_O=I_{O,min}$ to $I_{O,max}$, $C_o = 1\mu F // 10\mu F$ ceramic capacitors
Output Current Range	0	-	50	A	
Output DC Current Limit	-	180	-	%Io,max	Hiccup Mode
Output Short-Circuit Current	-	5.5	-	A	$V_o \leq 250mV$, Hiccup Mode
Output Capacitance					
ESR $\geq 1\ m\Omega$	-	-	1200	μF	Without the Tunable Loop™
ESR $\geq 10\ m\Omega$	-	-	10000	μF	Without the Tunable Loop™
ESR $\geq 1\ m\Omega$	-	-	20000	μF	With the Tunable Loop™
ESR $\geq 10\ m\Omega$	-	-	20000	μF	With the Tunable Loop™
Turn-On Delay Time	-	4.8	-	mS	Case 1: On/Off input is set to Logic Low (Module ON) and then input power is applied (delay from instant at which $V_{IN}=V_{IN,min}$ until $V_o=10\%$ of $V_{o,set}$)
	-	4.8	-	mS	Case 2: Input power is applied for at least one second and then the On/Off input is set to logic Low (delay from instant at which $V_{on/Off}=0.3V$ until $V_o=10\%$ of $V_{o,set}$)
Output voltage Rise time	-	3.6	-	mS	time for V_o to rise from 10% of $V_{o,set}$ to 90% of $V_{o,set}$
Output voltage overshoot	-	-	3	%Vo,set	$I_O=I_{O,max}$, $V_{in}=4.5$ to 14Vdc, $T_a=25^{\circ}C$

Note: Unless otherwise indicated, specifications apply over all operating input voltage, resistive load, and temperature conditions.

NON-ISOLATED DC/DC CONVERTERS

4.5 Vdc - 14 Vdc Input, 0.7 Vdc – 2 Vdc /50 A Outputs



Jul. 17 2015

Bel Power Inc., a subsidiary of Bel Fuse Inc.

General Specifications

Parameter	Min	Typ	Max	Unit	Notes
Efficiency Vo=0.7V Vo=1.2V Vo=1.8V	- - -	81.1 87.0 90.1	- - -	% % %	Vin= 12Vdc, Ta=25°C Io=Io, max, Vo= Vo,set
Switching Frequency	-	260	-	KHz	
Over Temperature Protection	-	125	-	°C	
Sequencing Slew rate capability	-	-	2	V/mS	VIN, min to VIN, max; Io, min to Io, max VSEQ < Vo
Sequencing Delay time	10	-	-	mS	Delay from VIN, min to application of voltage on SEQ pin
Tracking Accuracy Power-Up: 2V/ms Power-Down: 1V/ms	- -	100 200	200 400	mV mV	VIN, min to VIN, max; Io, min - Io, max VSEQ < Vo
PGOOD (Power Good) Internal pull-up, VPGOOD Overvoltage threshold for PGOOD Undervoltage threshold for PGOOD	- - -	5 112.5 87.5	- - -	V %Vo,set %Vo,set	
Forced Load Share Accuracy	-	10	-	%Io	
Number of Units in Parallel	-	-	5	-	
Weight	-	14.22	-	g	
MTBF	4,755,661			Hours	Calculated MTBF (Io=Io, max, Ta=40°C) per Telecordia Issue 2, Method I, Case 3
Dimensions Inches (L × W × H) Millimeters (L × W × H)	1.30 x 0.90 x 0.34 33 x 22.9 x 10			-	

Note: Unless otherwise indicated, specifications apply over all operating input voltage, resistive load, and temperature conditions.

NON-ISOLATED DC/DC CONVERTERS

4.5 Vdc - 14 Vdc Input, 0.7 Vdc – 2 Vdc /50 A Outputs



Jul. 17 2015

Bel Power Inc., a subsidiary of Bel Fuse Inc.

Efficiency Data

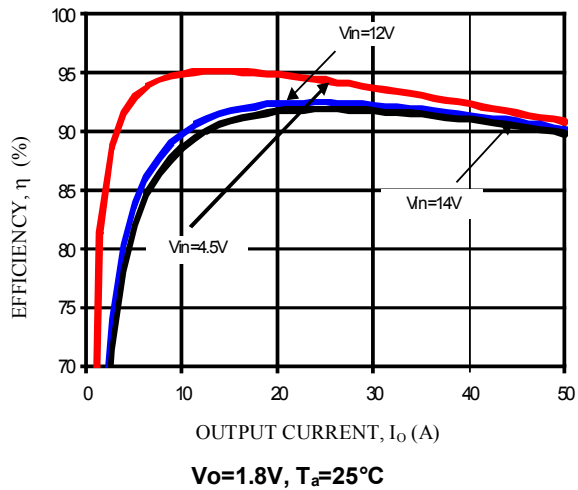
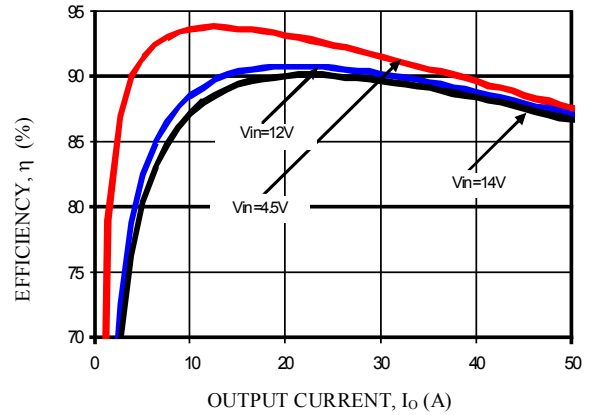
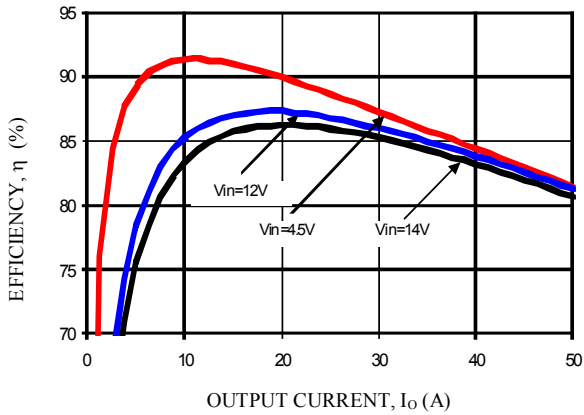

NON-ISOLATED DC/DC CONVERTERS

4.5 Vdc - 14 Vdc Input, 0.7 Vdc – 2 Vdc /50 A Outputs



Jul. 17 2015

Bel Power Inc., a subsidiary of Bel Fuse Inc.

Thermal Derating Curves

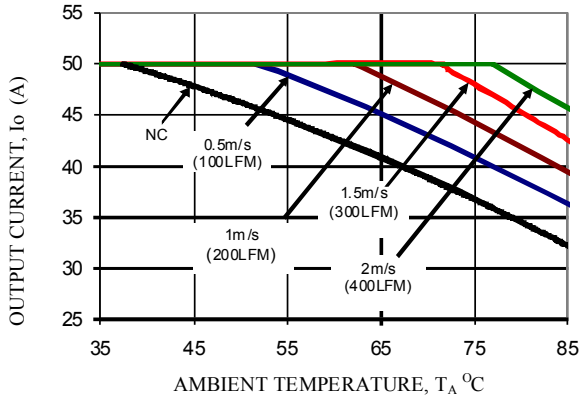

$V_o=0.7V$, $V_{in}=12V$

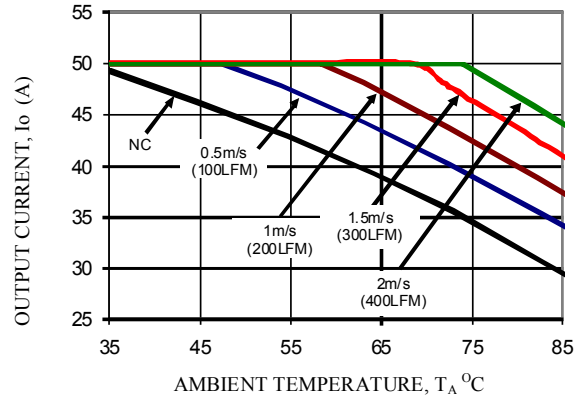

$V_o=1.2V$, $V_{in}=12V$

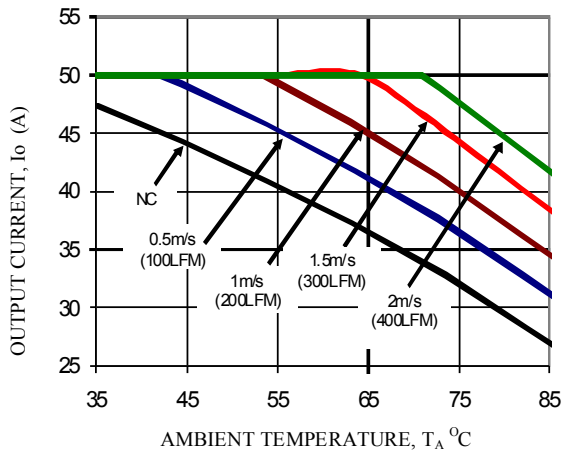

$V_o=1.8V$, $V_{in}=12V$

NON-ISOLATED DC/DC CONVERTERS

4.5 Vdc - 14 Vdc Input, 0.7 Vdc – 2 Vdc /50 A Outputs



Jul. 17 2015

Bel Power Inc., a subsidiary of Bel Fuse Inc.

Ripple and Noise Waveforms

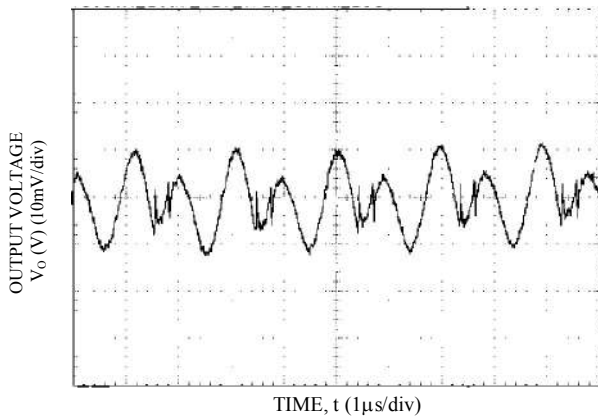

Vo=0.7V, Ta=25°C, Vin=12V, Io = Io,max

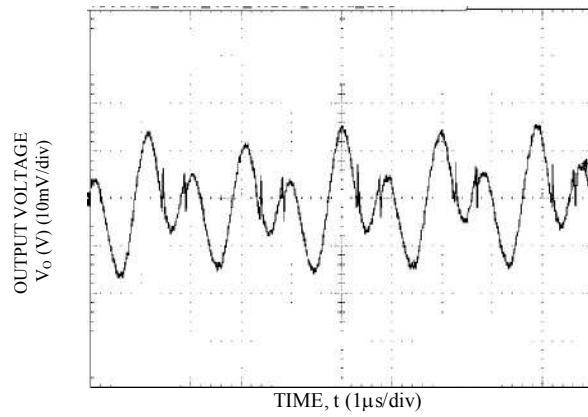

Vo=1.2V, Ta=25°C, Vin=12V, Io = Io,max

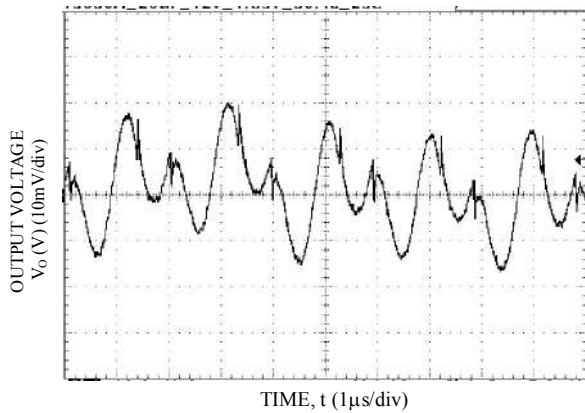

Vo=1.8V, Ta=25°C, Vin=12V, Io = Io,max

NON-ISOLATED DC/DC CONVERTERS

4.5 Vdc - 14 Vdc Input, 0.7 Vdc – 2 Vdc /50 A Outputs



Jul. 17 2015

Bel Power Inc., a subsidiary of Bel Fuse Inc.

Transient Response Waveforms

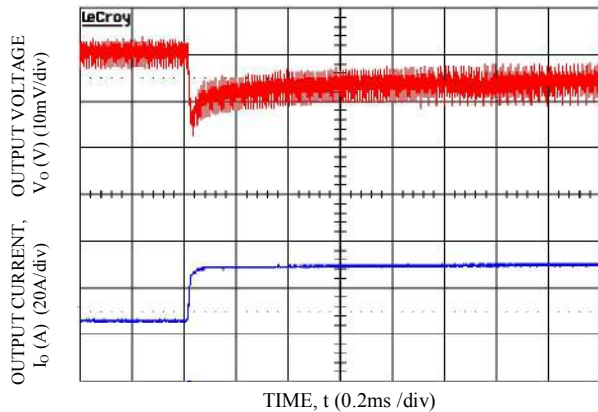

Transient Response to Dynamic Load Change from 50% to 100%. $V_o=0.7V$, $T_a=25^\circ C$, $V_{in}=12V$, $C_{ext}=5x47\mu F+22x330\mu F$ polymer, $C_{Tune}=330nF$, $R_{Tune}=100ohms$

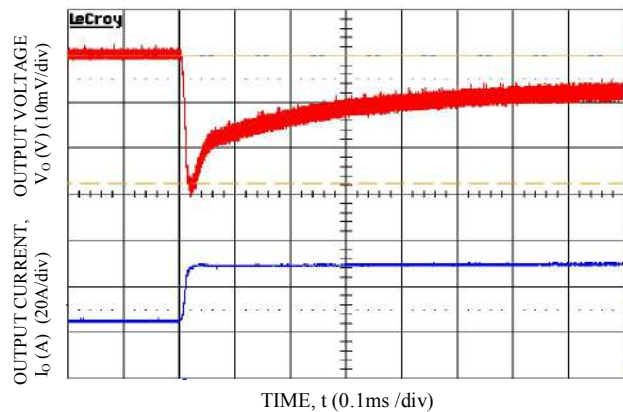

Transient Response to Dynamic Load Change from 50% to 100%. $V_o=1.2V$, $T_a=25^\circ C$, $V_{in}=12V$, $C_{ext}=5x47\mu F+13x330\mu F$ polymer, $C_{Tune}=120nF$, $R_{Tune}=180ohms$

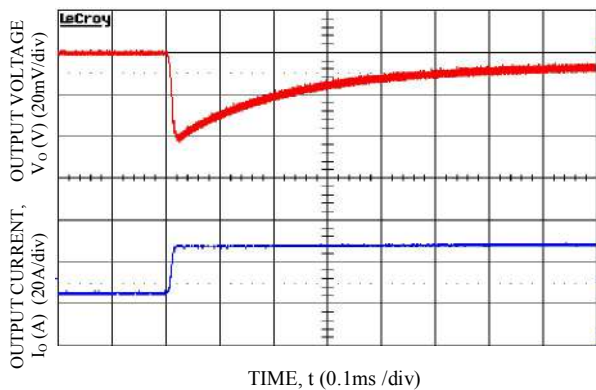

Transient Response to Dynamic Load Change from 50% to 100%. $V_o=1.8V$, $T_a=25^\circ C$, $V_{in}=12V$, $C_{ext}=5x47\mu F+8x330\mu F$ polymer, $C_{Tune}=47nF$, $R_{Tune}=220ohms$

NON-ISOLATED DC/DC CONVERTERS

4.5 Vdc - 14 Vdc Input, 0.7 Vdc – 2 Vdc /50 A Outputs



Jul. 17 2015

Bel Power Inc., a subsidiary of Bel Fuse Inc.

Startup Time

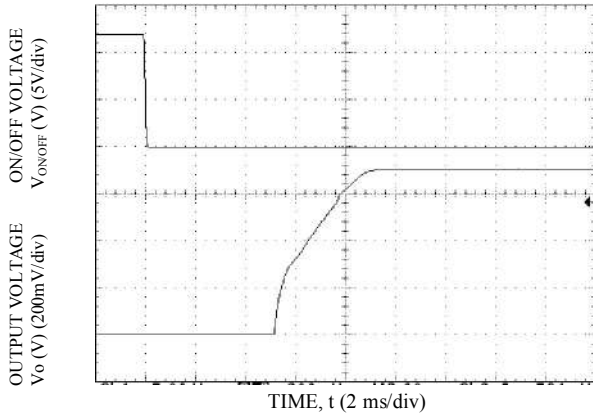

Start-up Using On/Off Voltage ($I_o = I_{o,max}$)
 $V_o=0.7V$, $V_{in} = 12V$, $T_a=25^\circ C$

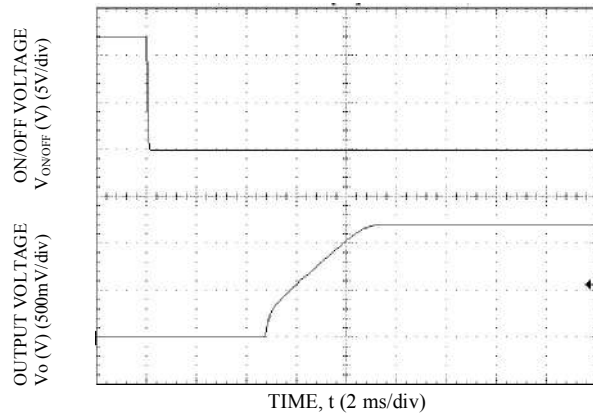

Start-up Using On/Off Voltage ($I_o = I_{o,max}$)
 $V_o=1.2V$, $V_{in} = 12V$, $T_a=25^\circ C$

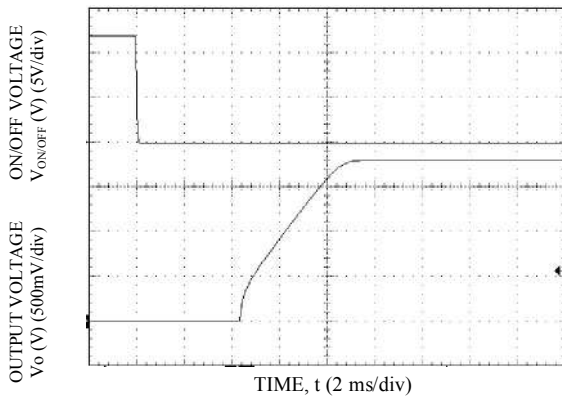

Start-up Using On/Off Voltage ($I_o = I_{o,max}$)
 $V_o=1.8V$, $V_{in} = 12V$, $T_a=25^\circ C$

NON-ISOLATED DC/DC CONVERTERS

4.5 Vdc - 14 Vdc Input, 0.7 Vdc – 2 Vdc /50 A Outputs



Jul. 17 2015

Bel Power Inc., a subsidiary of Bel Fuse Inc.

Startup Time (continued)

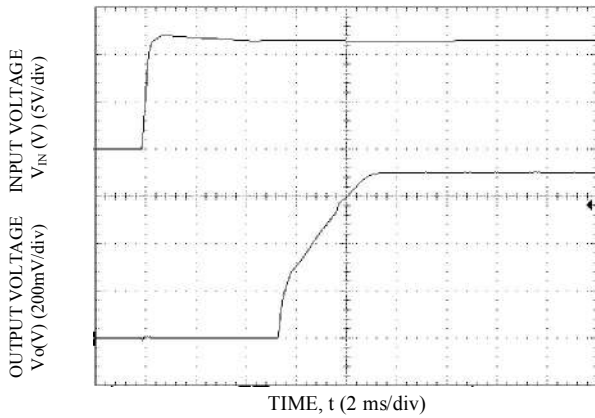

Start-up Using Input Voltage ($V_{IN} = 12V$, $I_o = I_{o,max}$),
 $V_o = 0.7V$, $T_a = 25^\circ C$

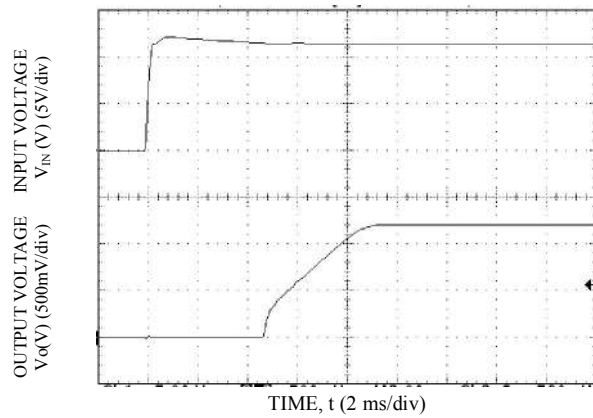

Start-up Using Input Voltage ($V_{IN} = 12V$, $I_o = I_{o,max}$),
 $V_o = 1.2V$, $T_a = 25^\circ C$

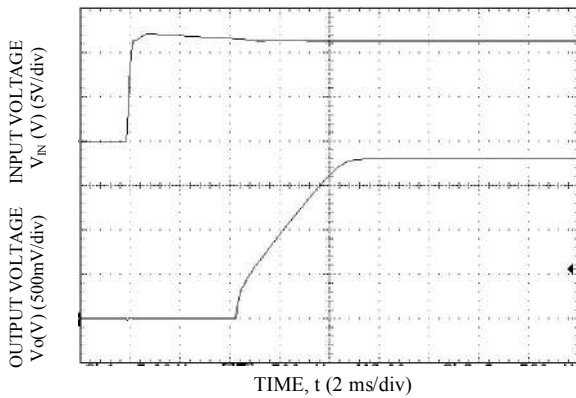

Start-up Using Input Voltage ($V_{IN} = 12V$, $I_o = I_{o,max}$),
 $V_o = 1.8V$, $T_a = 25^\circ C$

NON-ISOLATED DC/DC CONVERTERS

4.5 Vdc - 14 Vdc Input, 0.7 Vdc – 2 Vdc /50 A Outputs



Jul. 17 2015

Bel Power Inc., a subsidiary of Bel Fuse Inc.

Test Configurations

Input Reflected Ripple Current Test Setup.

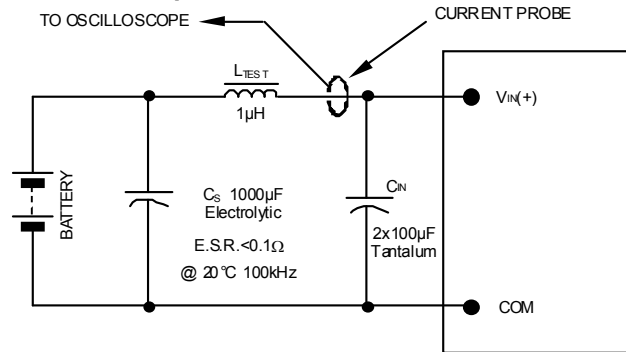

NOTE: Measure input reflected ripple current with a simulated source inductance (L_{TEST}) of 1µH. Capacitor C_S offsets possible battery impedance. Measure current as shown above.

Output Ripple and Noise Test Setup.

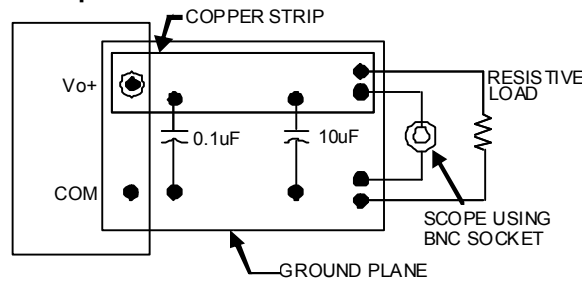

NOTE: All voltage measurements to be taken at the module terminals, as shown above. If sockets are used then Kelvin connections are required at the module terminals to avoid measurement errors due to socket contact resistance.

Output Voltage and Efficiency Test Setup.

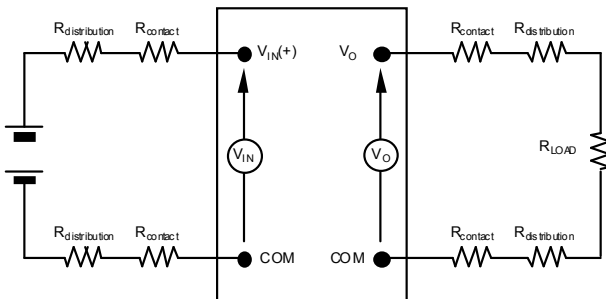

NOTE: All voltage measurements to be taken at the module terminals, as shown above. If sockets are used then Kelvin connections are required at the module terminals to avoid measurement errors due to socket contact resistance.

$$\text{Efficiency } \eta = \frac{V_O \cdot I_O}{V_{IN} \cdot I_{IN}} \times 100 \%$$

NON-ISOLATED DC/DC CONVERTERS

4.5 Vdc - 14 Vdc Input, 0.7 Vdc – 2 Vdc /50 A Outputs



Jul. 17 2015

Bel Power Inc., a subsidiary of Bel Fuse Inc.

Input Filtering

The SLIN-50E1AL module should be connected to a low ac-impedance source. A highly inductive source can affect the stability of the module. An input capacitor must be placed directly adjacent to the input pin of the module to minimize input ripple voltage and ensure module stability.

To minimize input voltage ripple, ceramic capacitors are recommended at the input of the module. The figure below shows the input ripple voltage for various output voltages at maximum load current with 2x22 μ F, 4x22 μ F or 4x47 μ F ceramic capacitors and an input of 12V.

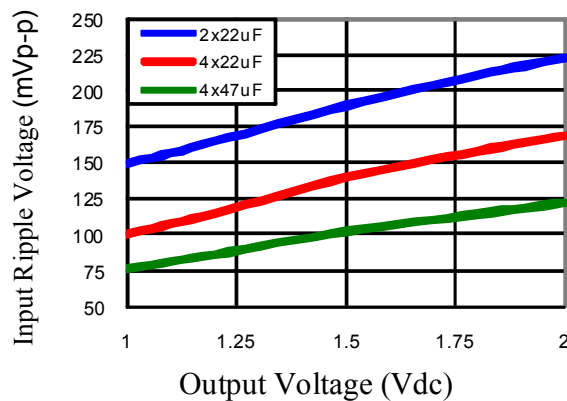

Output Filtering

The SLIN-50E1AL modules are designed for low output ripple voltage and will meet the maximum output ripple specification with 0.1 μ F ceramic and 10 μ F ceramic capacitors at the output of the module. However, additional output filtering may be required by the system designer for a number of reasons. First, there may be a need to further reduce the output ripple and noise of the module. Second, the dynamic response characteristics may need to be customized to a particular load step change.

To reduce the output ripple and improve the dynamic response to a step load change, additional capacitance at the output can be used. Low ESR polymer and ceramic capacitors are recommended to improve the dynamic response of the module. For stable operation of the module, limit the capacitance to less than the maximum output capacitance as specified in the electrical specification table. Optimal performance of the module can be achieved by using the Tunable Loop feature described later in this data sheet. The figure below shows the output ripple voltage for various output voltages with external 2x10 μ F, 2x47 μ F, 4x47 μ F or 8x47 μ F ceramic capacitors at the input voltage of 12V.

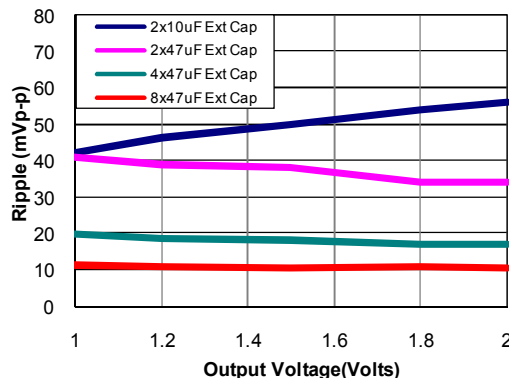

NON-ISOLATED DC/DC CONVERTERS

4.5 Vdc - 14 Vdc Input, 0.7 Vdc – 2 Vdc /50 A Outputs



Jul. 17 2015

Bel Power Inc., a subsidiary of Bel Fuse Inc.

Safety Considerations

For safety agency approval the power module must be installed in compliance with the spacing and separation requirements of the end-use safety agency standards, i.e., UL 60950-1 2nd Edition, CSA C22.2 No. 60950-1-07, DIN EN 60950-1:2006 + A11 (VDE0805 Teil 1 + A11):2009-11; EN 60950-1:2006 + A11:2009-03.

For the converter output to be considered meeting the requirements of safety extra-low voltage (SELV), the input must meet SELV requirements. The power module has extra-low voltage (ELV) outputs when all inputs are ELV. The input to these units is to be provided with a fast acting fuse with a maximum rating of 30A in the positive input lead.

Remote On/Off

Parameter	Min	Typ	Max	Unit	Notes
Signal Low (Unit On)	-0.3	-	0.6	V	The remote on/off pin open, Unit off.
Signal High (Unit Off)	3.0	-	V _{in,max}	V	

The SLIN-50E1AL power modules feature an On/Off pin for remote On/Off operation. If not using the On/Off pin, connect the pin to ground (the module will be ON). The On/Off signal ($V_{on/off}$) is referenced to ground. The circuit configuration for remote On/Off operation of the module using the On/Off pin is shown below.

During a Logic High on the On/Off pin (transistor Q1 is OFF), the module remains OFF. The external resistor R1 should be chosen to maintain 3.0V minimum on the On/Off pin to ensure that the module is OFF when transistor Q1 is in the OFF state. Suitable values for R1 are 4.7K for input voltage of 12V and 3K for 5V_{in}. During Logic-Low when Q1 is turned ON, the module is turned ON.

The On/Off pin can also be used to synchronize the output voltage start-up and shutdown of multiple modules in parallel. By connecting On/Off pins of multiple modules, the output start-up can be synchronized (please refer to characterization curves).

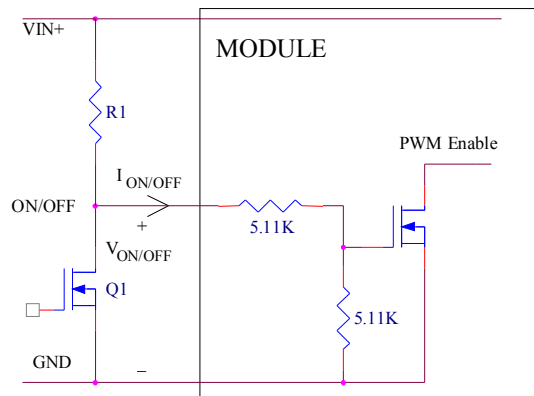

Remote On/Off Implementation using ON/OFF

Over Current Protection

To provide protection in a fault (output overload) condition, the unit should be equipped with internal current-limiting circuitry and can endure current limiting continuously. At the point of current-limit inception, the unit enters hiccup mode. The unit operates normally once the output current is brought back into its specified range.

NON-ISOLATED DC/DC CONVERTERS

4.5 Vdc - 14 Vdc Input, 0.7 Vdc – 2 Vdc /50 A Outputs



Jul. 17 2015

Bel Power Inc., a subsidiary of Bel Fuse Inc.

Over Temperature Protection

To provide protection in a fault condition, the unit is equipped with a thermal shutdown circuit. The unit will shutdown if the over temperature threshold of 125°C is exceeded at the thermal reference point T_{ref}. The thermal shutdown is not intended as a guarantee that the unit will survive temperatures beyond its rating. Once the unit goes into thermal shutdown it will then wait to cool before attempting to restart.

Input Under-voltage Lockout

At input voltages below the input under voltage lockout limit, the module operation is disabled. The module will begin to operate at an input voltage above the under voltage lockout turn-on threshold.

Output Voltage Programming

The output voltage of the SLIN-50E1AL can be programmed to any voltage from 0.7Vdc to 2.0Vdc by connecting a single resistor (shown as R_{trim} in the figure below) between Trim+ and Trim- pins of the module. The following equation will be used to set the output voltage of the module:

$$R_{trim} = \left[\frac{14000}{V_o - 0.7} \right] \Omega$$

R_{trim} is the external resistor in Ω
V_o is the desired output voltage

By using a ±0.5% tolerance trim resistor with a TC of ±100ppm, a set point tolerance of ±1.5% can be achieved as specified in the electrical specification. Table 1 provides R_{trim} values required for some common output voltages.

Table 1

V _{O, set} (V)	R _{trim} (KΩ)
0.7	Open
1.0	46.6
1.2	28
1.5	17.5
1.8	12.7

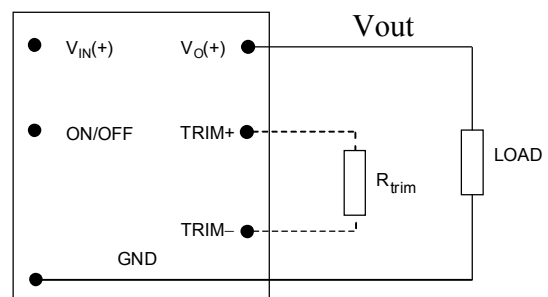

Circuit configuration to program output voltage using an external resistor

NON-ISOLATED DC/DC CONVERTERS

4.5 Vdc - 14 Vdc Input, 0.7 Vdc – 2 Vdc /50 A Outputs



Jul. 17 2015

Bel Power Inc., a subsidiary of Bel Fuse Inc.

Remote Sense

The SLIN-50E1AL power modules have differential Remote Sense to minimize the effects of distribution losses by regulating the voltage at the Remote Sense pin. The voltage between the SENSE pin and VOUT pin must not exceed 0.5V. Note that the output voltage of the module cannot exceed the specified maximum value. This includes the voltage drop between the SENSE and Vout pins. When the Remote Sense feature is not being used, connect the SENSE pin to the VOUT pin.

Voltage Margining

Output voltage margining can be implemented in the SLIN-50E1AL modules by connecting a resistor, $R_{\text{margin-up}}$, from the Trim pin to the ground pin for margining-up the output voltage and by connecting a resistor, $R_{\text{margin-down}}$, from the Trim pin to output pin for margining-down. The figure below shows the circuit configuration for output voltage margining.

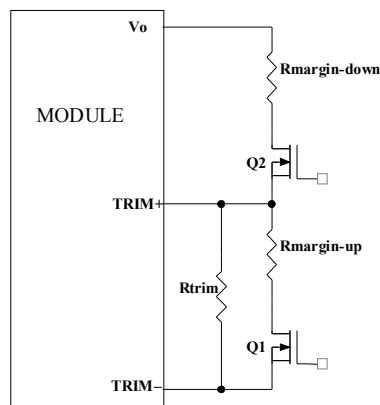

Circuit Configuration for margining Output voltage

Monotonic Start-up and Shutdown

The SLIN-50E1AL modules have monotonic start-up and shutdown behavior for any combination of rated input voltage, output current and operating temperature range.

Startup into Pre-biased Output

The SLIN-50E1AL modules can start into a prebiased output as long as the prebias voltage is 0.5V less than the set output voltage. Note that prebias operation is not supported when output voltage sequencing is used.

NON-ISOLATED DC/DC CONVERTERS

4.5 Vdc - 14 Vdc Input, 0.7 Vdc – 2 Vdc /50 A Outputs



Jul. 17 2015

Bel Power Inc., a subsidiary of Bel Fuse Inc.

Output Voltage Sequencing

The SLIN-50E1AL modules include a sequencing feature that enables users to implement various types of output voltage sequencing in their applications. This is accomplished via an additional sequencing pin. When not using the sequencing feature, leave it unconnected.

When an analog voltage is applied to the SEQ pin, the output voltage tracks this voltage until the output reaches the set-point voltage. The final value of the SEQ voltage must be set higher than the set-point voltage of the module. The output voltage follows the voltage on the SEQ pin on a one-to-one basis. By connecting multiple modules together, multiple modules can track their output voltages to the voltage applied on the SEQ pin.

For proper voltage sequencing, first, input voltage is applied to the module. The On/Off pin of the module is left unconnected or tied to GND so that the module is ON by default. After applying input voltage to the module, a minimum 10msec delay is required before applying voltage on the SEQ pin. Alternatively, input voltage can be applied while the unit is OFF and then the unit can be enabled. In this case the SEQ signal must be applied 10ms after the unit is enabled. This delay gives the module enough time to complete its internal power-up soft-start cycle. During the delay time, the SEQ pin may be held to ground.

After the 10msec delay, an analog voltage is applied to the SEQ pin and the output voltage of the module will track this voltage on a one-to-one volt basis until the output reaches the set-point voltage. To initiate simultaneous shutdown of the modules, the SEQ pin voltage is lowered in a controlled manner. The output voltage of the modules tracks the voltages below their set-point voltages on a one-to-one basis. A valid input voltage must be maintained until the tracking and output voltages reach ground potential.

When using the sequencing feature to control start-up of the module, pre-bias immunity during start-up is disabled. The pre-bias immunity feature of the module relies on the module being in the diode-mode during start-up. When using the sequencing feature, modules goes through an internal set-up time of 10msec, and will be in synchronous rectification mode when the voltage at the SEQ pin is applied. This will result in the module sinking current if a pre-bias voltage is present at the output of the module. When pre-bias immunity during start-up is required, the sequencing feature must be disabled. For additional guidelines on using the sequencing feature please contact the Bel Power technical representatives for additional information.

Power Good

The SLIN-50E1AL modules provide a Power Good (PGOOD) signal to indicate that the output voltage is within the regulation limits of the power module. The PGOOD signal will be de-asserted to a low state if any condition such as over-temperature, over-current or loss of regulation occurs that would result in the output voltage going $\pm 12.5\%$ outside the set point value. The PGOOD terminal is internally pulled-up and provides a voltage of 5V, when asserted, thus eliminating the need for an external source and pull-up resistor.

NON-ISOLATED DC/DC CONVERTERS

4.5 Vdc - 14 Vdc Input, 0.7 Vdc – 2 Vdc /50 A Outputs



Jul. 17 2015

Bel Power Inc., a subsidiary of Bel Fuse Inc.

Active Load Sharing

For additional power requirements, the SLIN-50E1AL power module is also available with a parallel option. Up to five modules can be configured, in parallel, with active load sharing.

Good layout techniques should be observed when using multiple units in parallel. To implement forced load sharing, the following connections should be made:

- The share pins of all units in parallel must be connected together. The path of these connections should be as direct as possible.
- All remote-sense pins should be connected to the power bus at the same point, i.e., connect all the SENSE(+) pins to the (+) side of the bus. Close proximity and directness are necessary for good noise immunity.

Some special considerations apply for design of converters in parallel operation:

- When sizing the number of modules required for parallel operation, take note of the fact that current sharing has some tolerance. In addition, under transient conditions such as a dynamic load change and during startup, all converter output currents will not be equal. To allow for such variation and avoid the likelihood of a converter shutting off due to a current overload, the total capacity of the paralleled system should be no more than 75% of the sum of the individual converters. As an example, for a system of four SLIN-50E1AL converters in parallel, the total current drawn should be less than 75% of (4 x 50A), i.e. less than 150A.
- All modules should be turned on and off together. This is so that all modules come up at the same time avoiding the problem of one converter sourcing current into the other leading to an over current trip condition. To ensure that all modules come up simultaneously, the on/off pins of all paralleled converters should be tied together and the converters enabled and disabled using the on/off pin.
- The share bus is not designed for redundant operation and the system will be non-functional upon failure of one of the unit when multiple units are in parallel. In particular, if one of the converters shuts down during operation, the other converters may also shut down due to their outputs hitting current limit. In such a situation, unless a coordinated restart is ensured, the system may never properly restart since different converters will try to restart at different times causing an overload condition and subsequent shutdown. This situation can be avoided by having an external output voltage monitor circuit that detects a shutdown condition and forces all converters to shut down and restart together. When not using the active load share feature, share pins should be left unconnected.

Tunable Loop™



The SLIN-50E1AL modules have a new feature that optimizes transient response of the module called Tunable Loop™.

External capacitors are usually added to the output of the module for two reasons: to reduce output ripple and noise and to reduce output voltage deviations from the steady-state value in the presence of dynamic load current changes. Adding external capacitance however affects the voltage control loop of the module, typically causing the loop to slow down with sluggish response. Larger values of external capacitance could also cause the module to become unstable.

The Tunable Loop™ allows the user to externally adjust the voltage control loop to match the filter network connected to the output of the module. The Tunable Loop™ is implemented by connecting a series R-C between the SENSE and TRIM pins of the module. This R-C allows the user to externally adjust the voltage loop feedback compensation of the module.

NON-ISOLATED DC/DC CONVERTERS

4.5 Vdc - 14 Vdc Input, 0.7 Vdc – 2 Vdc /50 A Outputs



Jul. 17 2015

Bel Power Inc., a subsidiary of Bel Fuse Inc.

Tunable Loop™ (continued)

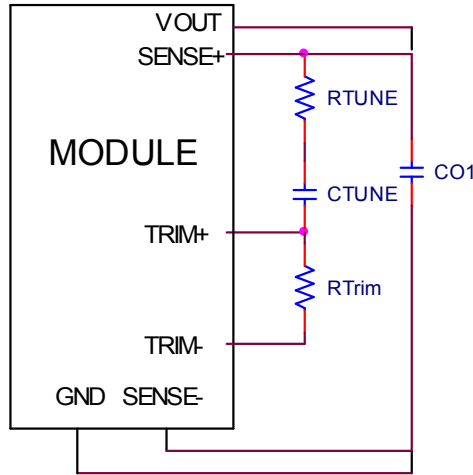

Circuit diagram showing connection of R_{TUNE} and C_{TUNE} to tune the control loop of the module

Recommended values of R_{TUNE} and C_{TUNE} for different output capacitor combinations are given in Tables 2 and 3. Table 2 shows the recommended values of R_{TUNE} and C_{TUNE} for different values of ceramic output capacitors up to 1000uF that might be needed for an application to meet output ripple and noise requirements. Selecting R_{TUNE} and C_{TUNE} according to Table 2 will ensure stable operation of the module.

In applications with tight output voltage limits in the presence of dynamic current loading, additional output capacitance will be required. Table 3 lists recommended values of R_{TUNE} and C_{TUNE} in order to meet 2% output voltage deviation limits for some common output voltages in the presence of a 25A to 50A step change (50% of full load), with an input voltage of 12V.

Table 2. General recommended values of R_{TUNE} and C_{TUNE} for $V_{in}=12V$ and various external ceramic capacitor combinations.

C_o	1 x 47uF	2x47uF	4x47uF	6x47uF	10 x 47uF	20 x 47uF
R_{TUNE}	330	330	330	330	270	270
C_{TUNE}	330pF	560pF	1200pF	1800pF	2200pF	5600pF

Table 3. Recommended values of R_{TUNE} and C_{TUNE} to obtain transient deviation of $\leq 2\%$ of V_{out} for a 25A step load with $V_{in}=12V$.

V_o	1.8V	1.2V	0.7V
C_o	5x47uF + 8x330uF polymer	5x47uF + 13x330uF polymer	5x47uF + 22x330uF polymer
R_{TUNE}	220	180	100
C_{TUNE}	47nF	120nF	330nF
ΔV	35mV	23mV	14mV

NON-ISOLATED DC/DC CONVERTERS

4.5 Vdc - 14 Vdc Input, 0.7 Vdc – 2 Vdc /50 A Outputs



Jul. 17 2015

Bel Power Inc., a subsidiary of Bel Fuse Inc.

Thermal Considerations

Power modules operate in a variety of thermal environments; however, sufficient cooling should always be provided to help ensure reliable operation.

Considerations include ambient temperature, airflow, module power dissipation, and the need for increased reliability. A reduction in the operating temperature of the module will result in an increase in reliability. The thermal data presented here is based on physical measurements taken in a wind tunnel. The test set-up is shown below.

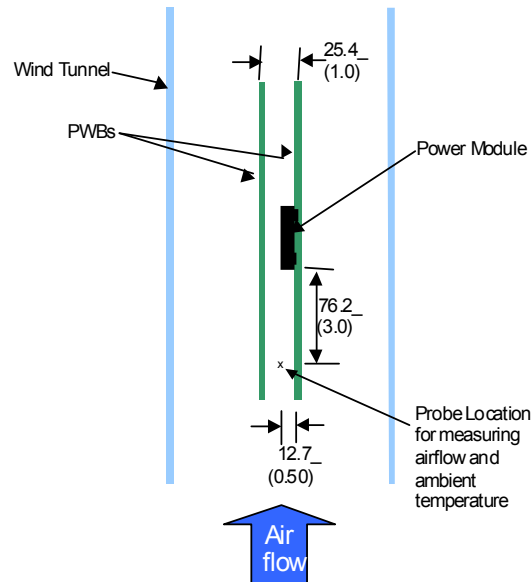

Thermal Test Setup

The thermal reference points, T_{ref} used in the specifications is shown below. For reliable operation the temperatures at this point should not exceed 125°C. The output power of the module should not exceed the rated power of the module ($V_{o,set} \times I_{o,max}$).

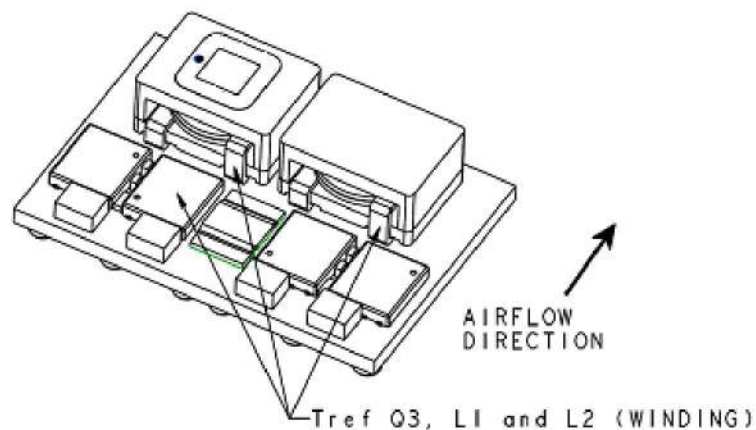

Preferred airflow direction and location of hot-spot of the module (T_{ref}).

NON-ISOLATED DC/DC CONVERTERS

4.5 Vdc - 14 Vdc Input, 0.7 Vdc – 2 Vdc /50 A Outputs



Jul. 17 2015

Bel Power Inc., a subsidiary of Bel Fuse Inc.

Example Application Circuit

Requirements:

Vin: 12V
Vout: 1.8V
Iout: 37.5A max., worst case load transient is from 25A to 37.5A
 ΔV_{out} : 1.5% of Vout (27mV) for worst case load transient
Vin, ripple: 1.5% of Vin (180mV, p-p)

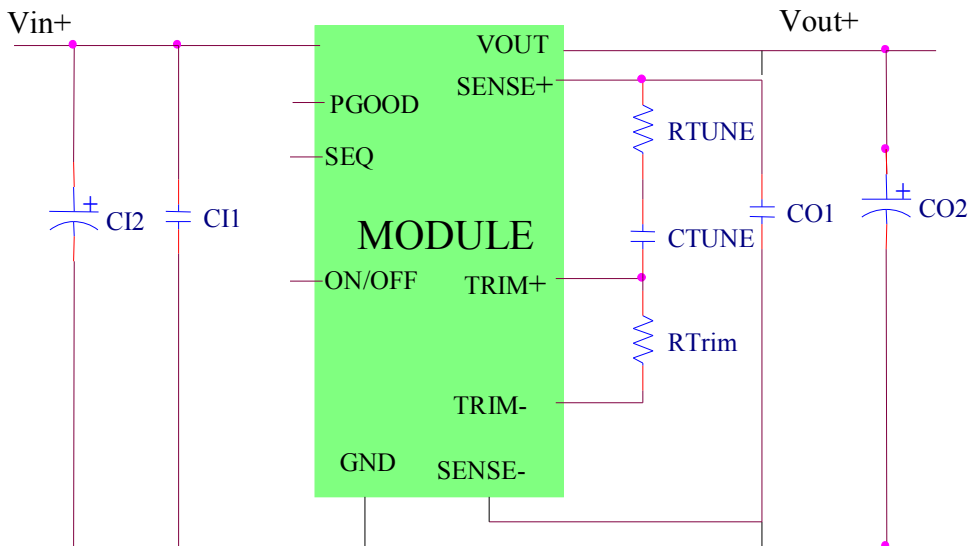

C11	4x22 μ F/16V ceramic capacitor (e.g. Murata GRM32ER61C226KE20)
C12	200 μ F/16V bulk electrolytic
CO1	5x47 μ F/6.3V ceramic capacitor (e.g. Murata GRM31CR60J476ME19)
CO2	8x 330 μ F/6.3V Polymer (e.g. Sanyo Poscap)
CTune	47nF ceramic capacitor (can be 1206, 0805 or 0603 size)
RTune	220 ohms SMT resistor (can be 1206, 0805 or 0603 size)
RTrim	12.7k Ω SMT resistor (can be 1206, 0805 or 0603 size, recommended tolerance of 0.1%)

NON-ISOLATED DC/DC CONVERTERS

4.5 Vdc - 14 Vdc Input, 0.7 Vdc - 2 Vdc /50 A Outputs



Jul. 17 2015

Bel Power Inc., a subsidiary of Bel Fuse Inc.

Mechanical Outline

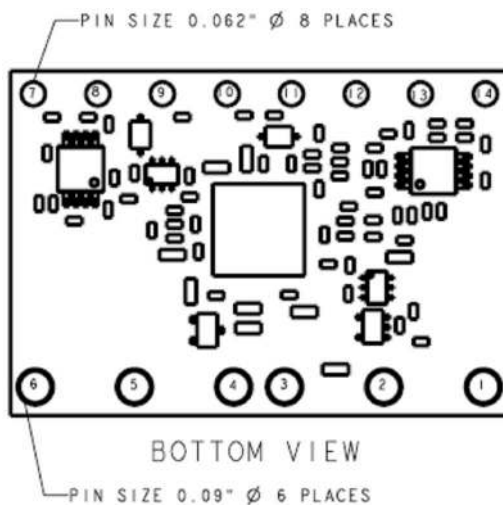
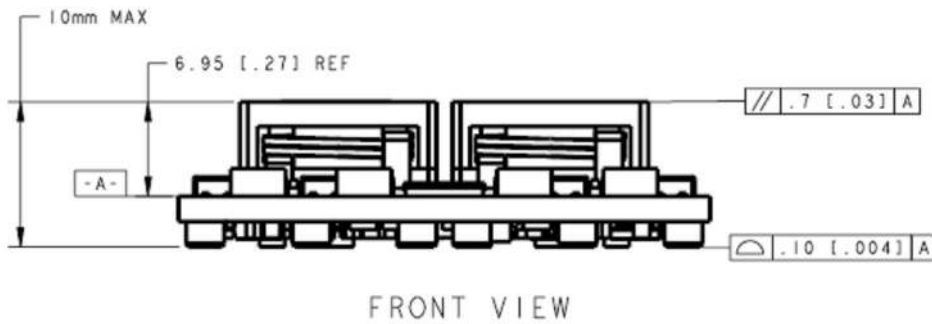
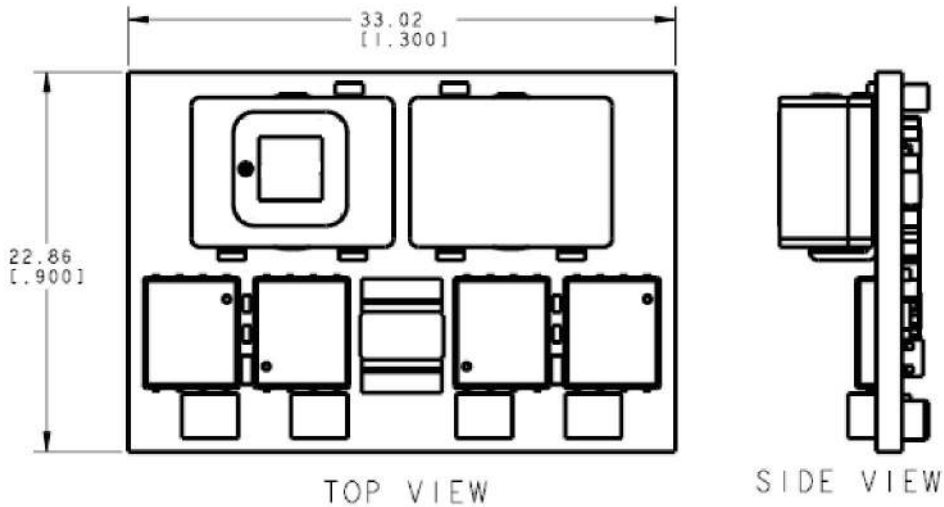

NON-ISOLATED DC/DC CONVERTERS

4.5 Vdc - 14 Vdc Input, 0.7 Vdc – 2 Vdc /50 A Outputs



Jul. 17 2015

Bel Power Inc., a subsidiary of Bel Fuse Inc.

Mechanical Outline (continued)

Recommended Pad Layout

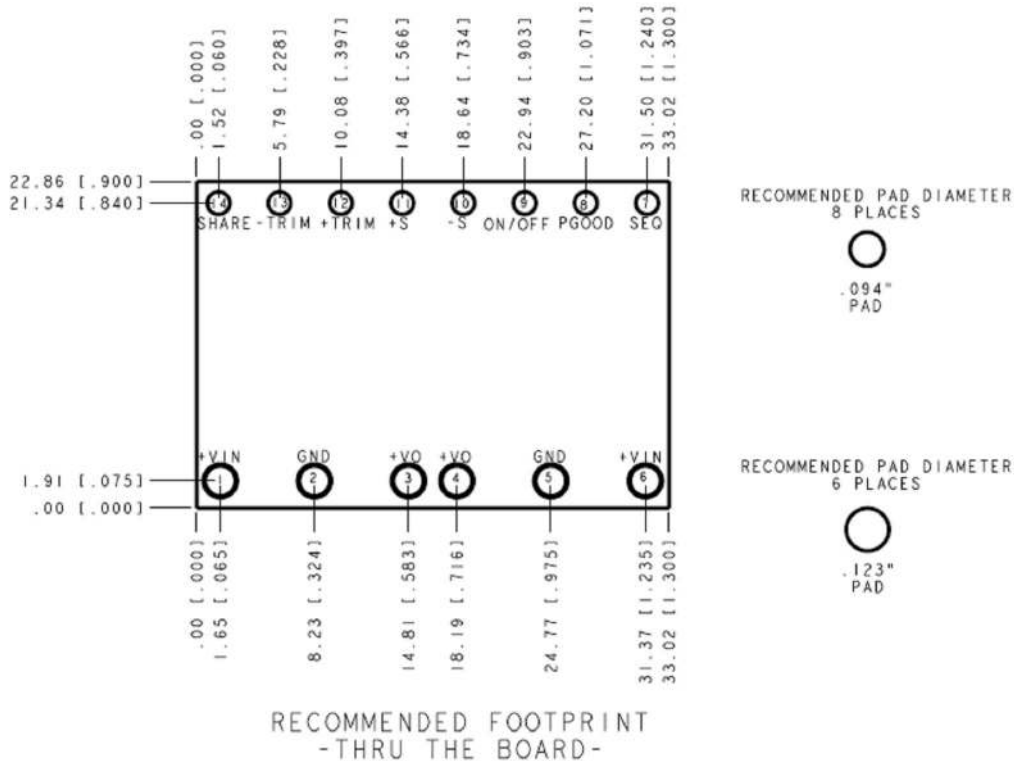

Pin Define

pin#	function
1	VIN
2	GND
3	VOUT
4	VOUT
5	GND
6	VIN
7	SEQ
8	PGOOD
9	ON/OFF
10	VS-
11	VS+
12	+TRIM
13	-TRIM
14	SHARE

Dimensions are in millimeters and (inches).

Tolerances: x.x mm ± 0.5 mm (x.xx in. ± 0.02 in.) [Unless otherwise indicated]

x.xx mm ± 0.25 mm (x.xxx in ± 0.010 in.)

Note: These parts are not however compatible with the higher temperatures associated with lead free solder processes and must be soldered using a reflow profile with a peak temperature of no more than 245 °C.

NON-ISOLATED DC/DC CONVERTERS

4.5 Vdc - 14 Vdc Input, 0.7 Vdc – 2 Vdc /50 A Outputs



Jul. 17 2015

Bel Power Inc., a subsidiary of Bel Fuse Inc.

Packaging Details

The SLIN-50E1AL modules are supplied in tape & reel as standard.

All Dimensions are in millimeters and (in inches).

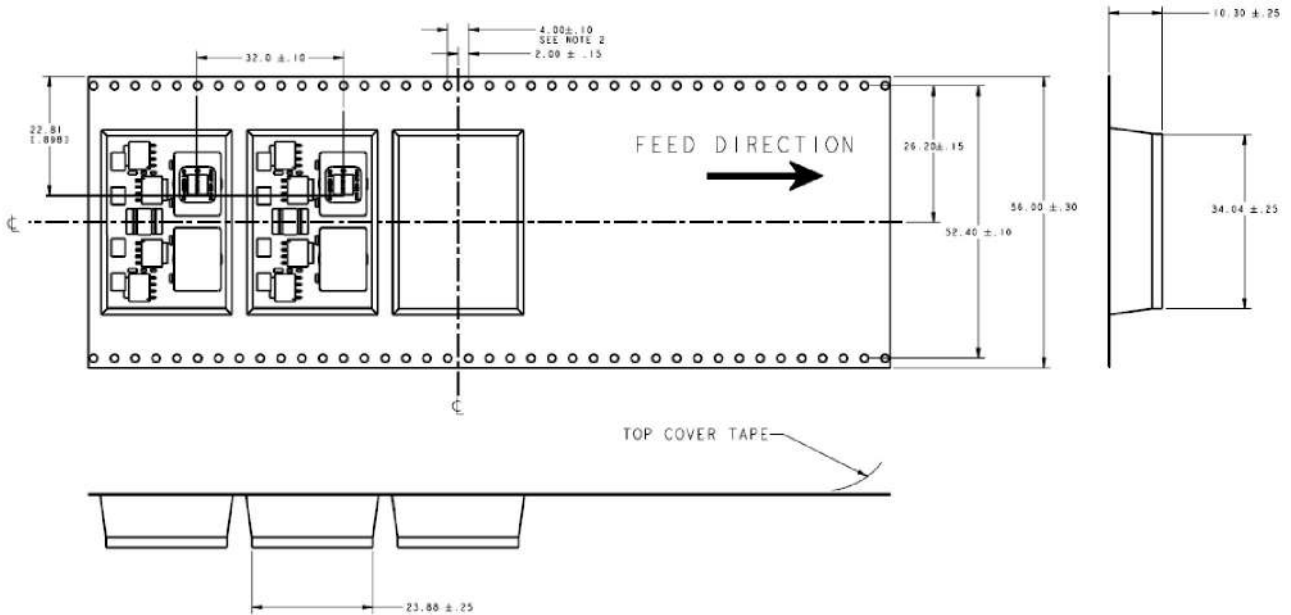

Reel Dimensions:

Outside Dimensions: 330.2 mm (13.00")

Inside Dimensions: 177.8 mm (7.00")

Tape Width: 56.00 mm (2.20")

NON-ISOLATED DC/DC CONVERTERS

4.5 Vdc - 14 Vdc Input, 0.7 Vdc – 2 Vdc /50 A Outputs



Jul. 17 2015

Bel Power Inc., a subsidiary of Bel Fuse Inc.

Surface Mount Information

Pick and Place

The SLIN-50E1AL modules use an open frame construction and are designed for a fully automated assembly process. The modules are fitted with a label designed to provide a large surface area for pick and place operations. The label meets all the requirements for surface mount processing, as well as safety standards, and is able to withstand reflow temperatures of up to 300°C. The label also carries product information such as part number and serial number.

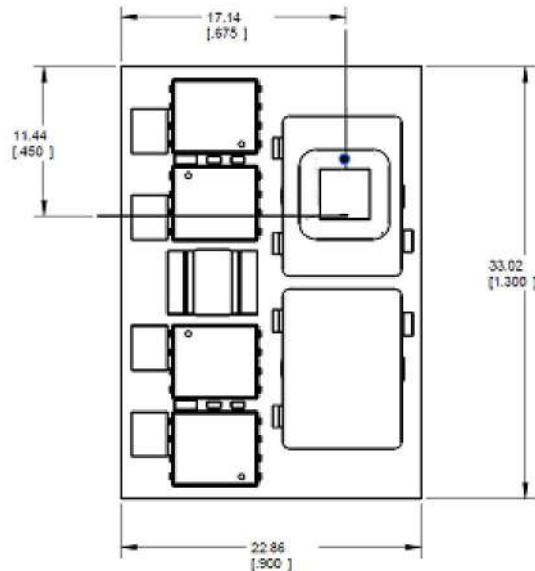

Pick and Place Location.

Nozzle Recommendations

The module weight has been kept to a minimum by using open frame construction. Even so, these modules have a relatively large mass when compared to conventional SMT components. Variables such as nozzle size, tip style, vacuum pressure and pick & placement speed should be considered to optimize this process. The minimum recommended inside nozzle diameter for reliable operation is 3mm. The maximum nozzle outer diameter, which will safely fit within the allowable component spacing, is 5 mm max.

Bottom Side Assembly

This module is not recommended for assembly on the bottom side of a customer board. If such an assembly is attempted, components may fall off the module during the second reflow process. If assembly on the bottom side is planned, please contact Bel Power for special manufacturing process instructions.

Lead Free Soldering

The SLIN-50E1AL modules are lead-free (Pb-free) and RoHS compliant and are both forward and backward compatible in a Pb-free and a SnPb soldering process. Failure to observe the instructions may result in the failure of or cause damage to the modules and can adversely affect long-term reliability.

NON-ISOLATED DC/DC CONVERTERS

4.5 Vdc - 14 Vdc Input, 0.7 Vdc – 2 Vdc /50 A Outputs



Jul. 17 2015

Bel Power Inc., a subsidiary of Bel Fuse Inc.

Surface Mount Information (Continued)

Pb-free Reflow Profile

Power Systems will comply with J-STD-020 Rev. C (Moisture/Reflow Sensitivity Classification for Nonhermetic Solid State Surface Mount Devices) for both Pb-free solder profiles and MSL classification procedures. This standard provides a recommended forced-air-convection reflow profile based on the volume and thickness of the package. The suggested Pb-free solder paste is Sn/Ag/Cu (SAC). The recommended linear reflow profile using Sn/Ag/Cu solder is shown below.

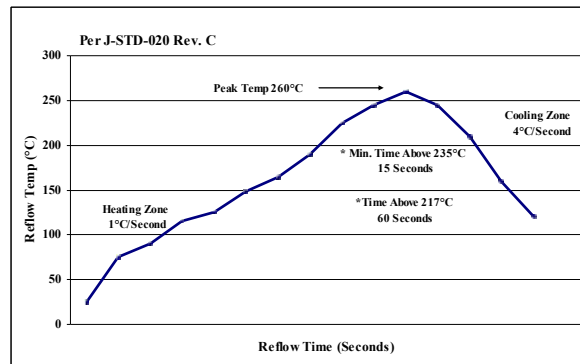

Note: Soldering outside of the recommended profile requires testing to verify results and performance.

Tin Lead Soldering

The SLIN-50E1AL power modules are lead free modules and can be soldered either in a lead-free solder process or in a conventional Tin/Lead (Sn/Pb) process. It is recommended that the customer review data sheets in order to customize the solder reflow profile for each application board assembly. The following instructions must be observed when soldering these units. Failure to observe these instructions may result in the failure of or cause damage to the modules, and can adversely affect long-term reliability.

In a conventional Tin/Lead (Sn/Pb) solder process peak reflow temperatures are limited to less than 235°C. Typically, the eutectic solder melts at 183°C, wets the land, and subsequently wicks the device connection. Sufficient time must be allowed to fuse the plating on the connection to ensure a reliable solder joint. There are several types of SMT reflow technologies currently used in the industry. These surface mount power modules can be reliably soldered using natural forced convection, IR (radiant infrared), or a combination of convection/IR. For reliable soldering the solder reflow profile should be established by accurately measuring the modules CP connector temperatures.

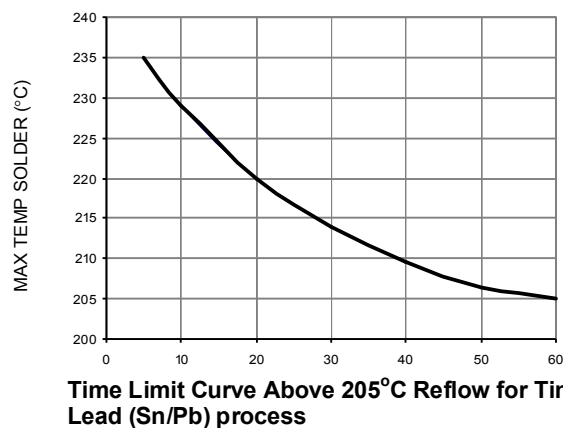
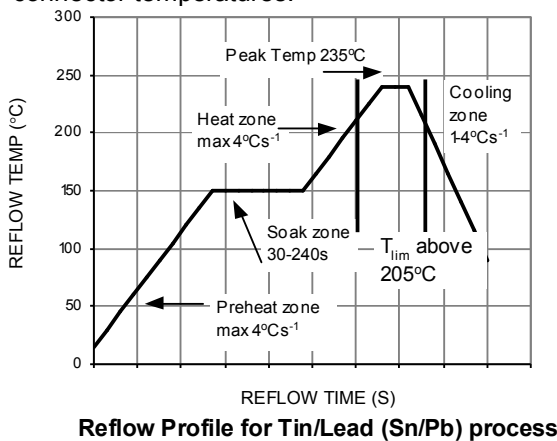

NON-ISOLATED DC/DC CONVERTERS

4.5 Vdc - 14 Vdc Input, 0.7 Vdc – 2 Vdc /50 A Outputs



Jul. 17 2015

Bel Power Inc., a subsidiary of Bel Fuse Inc.

Surface Mount Information (Continued)

MSL Rating

The SLIN-50E1AL modules have a MSL rating of 2A.

Storage and Handling

The recommended storage environment and handling procedures for moisture-sensitive surface mount packages is detailed in J-STD-033 Rev. A (Handling, Packing, Shipping and Use of Moisture/Reflow Sensitive Surface Mount Devices). Moisture barrier bags (MBB) with desiccant are required for MSL ratings of 2 or greater. These sealed packages should not be broken until time of use. Once the original package is broken, the floor life of the product at conditions of $\leq 30^{\circ}\text{C}$ and 60% relative humidity varies according to the MSL rating (see J-STD-033A). The shelf life for dry packed SMT packages will be a minimum of 12 months from the bag seal date, when stored at the following conditions: $< 40^{\circ}\text{C}$, $< 90\%$ relative humidity.

Post Solder Cleaning and Drying Considerations

Post solder cleaning is usually the final circuit-board assembly process prior to electrical board testing. The result of inadequate cleaning and drying can affect both the reliability of a power module and the testability of the finished circuit-board assembly.

NON-ISOLATED DC/DC CONVERTERS

4.5 Vdc - 14 Vdc Input, 0.7 Vdc – 2 Vdc /50 A Outputs



Jul. 17 2015

Bel Power Inc., a subsidiary of Bel Fuse Inc.

Revision History

Date	Revision	Changes Detail	Approval
2011-2-18	A	First release	T. Bubriski
2011-8-29	B	Update the reflow solder temperature.	HL
2012-9-5	C	Updated MSL rating.	HL
2014-6-25	D	Updated Packaging.	Falling Tao
2015-7-17	E	Update transient response waveforms and active load sharing.	XF

RoHS Compliance

Complies with the European Directive 2011/65/EU, calling for the elimination of lead and other hazardous substances from electronic products.



©2015 Bel Fuse Inc. Specifications subject to change without notice. 071715

27

CORPORATE

Bel Fuse Inc.
206 Van Vorst Street
Jersey City, NJ 07302
Tel 201-432-0463
Fax 201-432-9542
www.belfuse.com

FAR EAST

Bel Fuse Ltd.
8F/ 8 Luk Hop Street
San Po Kong
Kowloon, Hong Kong
Tel 852-2328-5515
Fax 852-2352-3706
www.belfuse.com

EUROPE

Bel Fuse Europe Ltd.
Preston Technology Management Centre
Marsh Lane, Suite G7, Preston
Lancashire, PR1 8UD, U.K.
Tel 44-1772-556601
Fax 44-1772-888366
www.belfuse.com