

Gateway for integration of LG air conditioners into KNX TP-
1 (EIB) control systems

Compatible with VRF air conditioners commercialized by LG
Application's Program Version: 1.4

USER MANUAL

Issue date: 07/2020 r1.7 ENGLISH

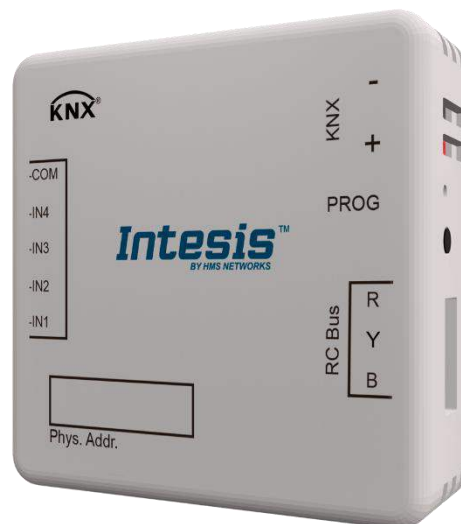

Important User Information

Disclaimer

The information in this document is for informational purposes only. Please inform HMS Industrial Networks of any inaccuracies or omissions found in this document. HMS Industrial Networks disclaims any responsibility or liability for any errors that may appear in this document.

HMS Industrial Networks reserves the right to modify its products in line with its policy of continuous product development. The information in this document shall therefore not be construed as a commitment on the part of HMS Industrial Networks and is subject to change without notice. HMS Industrial Networks makes no commitment to update or keep current the information in this document.

The data, examples and illustrations found in this document are included for illustrative purposes and are only intended to help improve understanding of the functionality and handling of the product. In view of the wide range of possible applications of the product, and because of the many variables and requirements associated with any particular implementation, HMS Industrial Networks cannot assume responsibility or liability for actual use based on the data, examples or illustrations included in this document nor for any damages incurred during installation of the product. Those responsible for the use of the product must acquire sufficient knowledge in order to ensure that the product is used correctly in their specific application and that the application meets all performance and safety requirements including any applicable laws, regulations, codes and standards. Further, HMS Industrial Networks will under no circumstances assume liability or responsibility for any problems that may arise as a result from the use of undocumented features or functional side effects found outside the documented scope of the product. The effects caused by any direct or indirect use of such aspects of the product are undefined and may include e.g. compatibility issues and stability issues.

Gateway for integration of LG air conditioners into KNX TP-1 (EIB) control systems.

Compatible with VRF air conditioners commercialized by LG.

Application's Program Version: 1.4

ORDER CODE	LEGACY ORDER CODE
INKNXLGE001R000	LG-RC-KNX-1i

INDEX

1.	Presentation	6
2.	Connection	7
2.1	INKNXLGE001R000 with LG Remote Controller.....	7
3.	Configuration and setup	7
4.	ETS Parameters	8
4.1	General dialog	8
4.1.1	LG protocol type	9
4.1.2	INKNXLGE001R000 is master in bus (3-wire).....	9
4.1.3	Send READs for Control_ objects on bus recovery	9
4.1.4	Scene to load on bus recovery / startup	10
4.1.5	Disallow control from remote controller.....	10
4.1.6	Enable func "Control_ Lock Control Obj"	10
4.1.7	Enable func "Operating Hours Counter"	11
4.1.8	Enable object "Error Code [2byte]"	11
4.1.9	Enable object "Error Text Code [14byte]"	12
4.2	Mode Configuration dialog	12
4.2.1	Indoor unit has HEAT mode	13
4.2.2	Indoor unit has AUTO mode.....	13
4.2.3	Enable "Mode Cool/Heat" objects	13
4.2.4	Enable PID-Compat. Scaling Mode Objects (for Control).....	13
4.2.5	Enable use of + / - object for Mode	14
4.2.6	Enable use of bit-type Mode objects (for control)	15
4.2.7	Enable use of bit-type Mode objects (for status).....	15
4.2.8	Enable use of Text object for Mode	15
4.3	Special Modes Configuration dialog	16
4.3.1	Enable use of POWER mode.....	16
4.3.2	Enable use of ECONOMY mode.....	17
4.3.3	Enable use of ADDITIONAL HEATING mode	18
4.3.4	Enable use of ADDITIONAL COOLING mode.....	19
4.4	Fan Speed Configuration dialog	19
4.4.1	Available fanspeeds in Indoor Unit.....	20
4.4.2	Indoor unit has AUTO fan speed	20
4.4.3	DPT object type for Fan Speed	20
4.4.4	Enable use of +/- object for Fan Speed	21
4.4.5	Enable "Fan Speed Man/Auto" objects (for Control and Status)	22
4.4.6	Enable use of bit-type Fan Speed objects (for Control).....	22
4.4.7	Enable use of bit-type Fan Speed objects (for Status).....	22
4.4.8	Enable use of Text object for Fan Speed	23
4.5	Vanes Up-Down Configuration dialog	23
4.5.1	Indoor unit has U-D Vanes	23
4.5.2	Indoor unit has Vanes Swirl (for U-D vanes)	24
4.5.3	Indoor unit has L-R Vanes	24
4.5.4	Indoor unit has Vanes Swirl (for U-D vanes)	25
4.6	Temperature Configuration dialog.....	25
4.6.1	Periodic sending of "Status_ AC Setp"	25
4.6.2	Transmission of "Status_ AC Ref Temp"	26
4.6.3	Enable use of +/- object for Setpoint Temp	26
4.6.4	Enable limits on Control_ Setpoint obj	27
4.6.5	Ambient temp. ref. is provided from KNX	27
4.7	Scene Configuration dialog	28
4.7.1	Enable use of scenes	29
4.7.2	Scenes can be stored from KNX bus	29
4.7.3	Enable use of bit objects for scene execution	30
4.7.4	Scene "x" preset	30
4.8	Switch-Off Timeouts Configuration dialog	32
4.8.1	Enable use of Open Window / Switch off timeout function	32

4.8.2	Enable use of Occupancy function	33
4.8.3	Enable use of SLEEP timeout	36
4.9	Binary Input "x" Configuration dialog	36
4.9.1	Enable use of Input "x"	36
4.9.2	Contact type.....	37
4.9.3	Debounce time	37
4.9.4	Disabling function.....	37
4.9.5	Function.....	37
5.	Specifications.....	45
6.	AC Unit Types compatibility	46
7.	Error Codes	47
8.	Appendix A – Communication Objects Table	49

1. Presentation



INKNXLGE001R000 allows a complete and natural integration of LG air conditioners with KNX control systems.

Compatible with VRF Series air conditioners commercialized by LG.

Main features:

- Reduced dimensions, quick installation.
- Multiple objects for control and status (bit, byte, characters...) with KNX standard datapoint types.
- Status objects for every control available.
- Timeout for Open Window and Occupancy. Sleep function also available.
- Control of the AC unit based in the ambient temperature read by the own AC unit, or in the ambient temperature read by any KNX thermostat.
- AC unit can be controlled simultaneously by the wired remote control of the AC unit and by KNX.
- Total Control and Monitoring of the AC unit from KNX, including monitoring of AC unit's state of internal variables, running hours counter (for filter maintenance control), and error indication and error code.
- Up to 5 scenes can be saved and executed from KNX, fixing the desired combination of Operation Mode, Set Temperature, Fan Speed, Vane Position and Remote Controller Lock in any moment by using a simple switching.
- Four binary inputs for potential-free contacts provide the possibility to integrate many types of external devices. Also configurable from ETS, they can be used for switching, dimming, shutter/blind control, and more

2. Connection

Connection of the INKNXLGE001R000 to the AC indoor unit

The INKNXLGE001R000 can be connected directly to the RYB bus of the indoor unit (no LG remote controller -RC from now on- connected in the RYB bus) or with the LG RC. See connection diagram below.

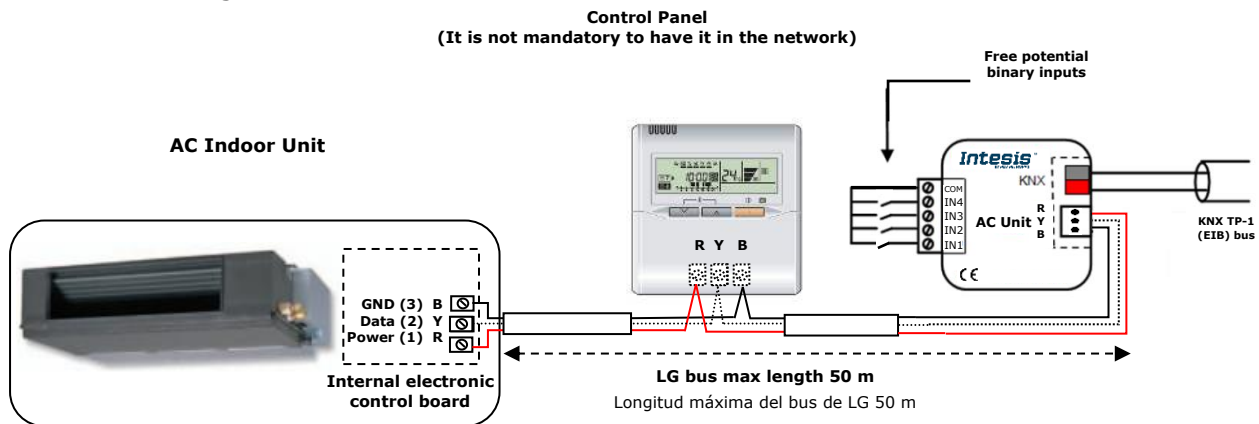

Attention: The LG Type A units do not allow a remote controller and INKNXLGE001R000 device installed together.

Figure 2.1 INKNXLGE001R000 connection diagrams

2.1 **INKNXLGE001R000 with LG Remote Controller**

Connection of the INKNXLGE001R000 to the KNX bus:

Disconnect power of the KNX bus. Connect the INKNXLGE001R000 to the KNX TP-1 (EIB) bus using the KNX standard connector (red/grey) of the INKNXLGE001R000, respect polarity.

Reconnect power of the KNX bus, and mains power of the AC unit.

3. Configuration and setup

This is a fully compatible KNX device which must be configured and setup using standard KNX tool ETS.

ETS database for this device can be downloaded from:

<https://intesis.com/products/ac-interfaces/lg-gateways/lg-knx-inputs-vrf-lg-rc-knx-1i>

Please consult the README.txt file, located inside the downloaded zip file, to find instructions on how to install the database.

⚠ Important: Do not forget to select the correct settings of AC indoor unit being connected to the INKNXLGE001R000. This is in "Parameters" of the device in ETS.

4. ETS Parameters

When imported to the ETS software for the first time, the gateway shows the following default parameter configuration:

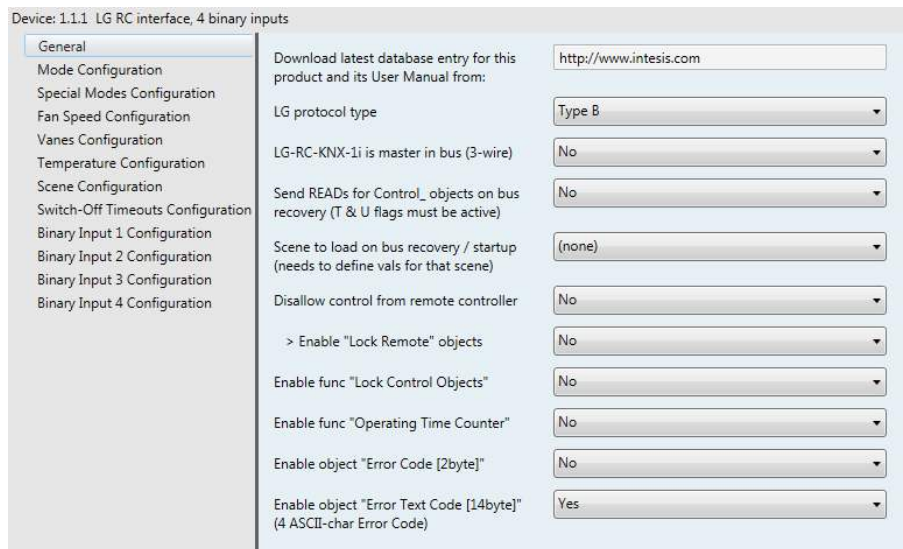

Figure 4.1 Default parameter configuration

With this configuration it's possible to send On/Off (*Control_ On/Off*), change the AC Mode (*Control_ Mode*), the Fan Speed (*Control_ Fan Speed*) and also the Setpoint Temperature (*Control_ Setpoint Temperature*). The *Status_* objects, for the mentioned *Control_* objects, are also available to use if needed. Also objects *Status_ AC Return Temp* and *Status_ Error/Alarm* are shown.

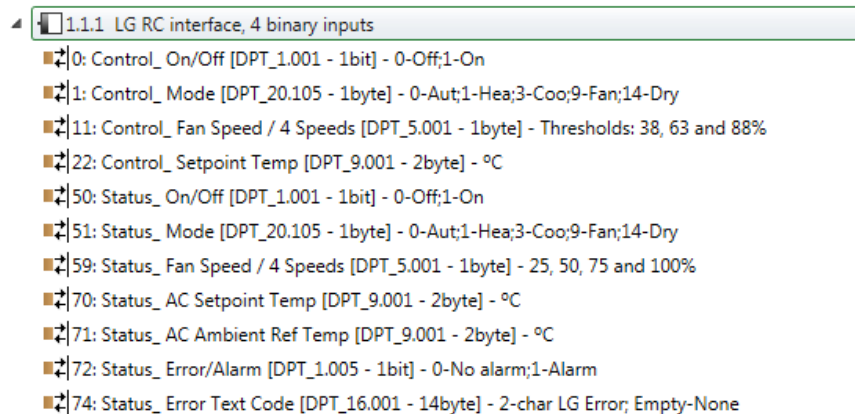

Figure 4.2 Default communication objects

4.1 General dialog

Inside this parameter's dialog it is possible to activate or change the parameters shown in the **Figure 4.1**.

The first field shows the URL where to download the database and the user manual for the product.

4.1.1 LG protocol type

This parameter is used to differentiate between the Type A and Type B units. Please, leave it in Type B (as per default).¹

4.1.2 INKNXLGE001R000 is master in bus (3-wire)

This parameter changes the gateway's behavior, being able to program it as master or slave in LG bus.

- If set to **"No"**, the gateway will work as a slave.
- If set to **"Yes"** the gateway will be master of the bus. It is not necessary to have any remote controller in this case but, if there are, they must be configured as slaves. The next parameter is also shown when selecting INKNXLGE001R000 as master in LG bus:

Figure 4.3 Parameter detail

- Apply "Min Ambient Temp":

If set to **"Yes"**, the minimum ambient temperature set on the LG system will apply.

4.1.3 Send READs for Control_ objects on bus recovery

When this parameter is enabled, INKNXLGE001R000 will send READ telegrams for the group addresses associated on its *Control_* objects on bus recovery or application reset/start-up.

- If set to **"No"** the gateway will not perform any action.
- If set to **"Yes"** all *Control_* objects with both Transmit (**T**) and Update (**U**) flags enabled will send READs and their values will be updated with the response when received.

Figure 4.3 Parameter detail

- Delay before sending READs (sec):

With this parameter, a delay can be configured between 0 and 30 seconds for the READs sent by the *Control_* objects. This is to give time enough to other KNX devices on the bus to start-up before sending the READs.

¹ Type A should be use only under very specific circumstances. Contact HMS Networks before selecting A type.

4.1.4 Scene to load on bus recovery / startup

This parameter executes a selected scene on bus recovery or startup, only if the selected scene has an enabled preset or values previously saved from KNX bus (see Scene Configuration dialog).

If the gateway is disconnected from the indoor unit the scene will not be applied, even when connecting to the indoor unit again.

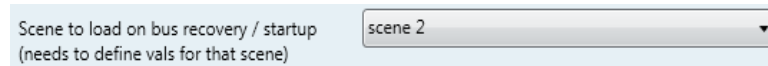

Figure 4.4 Parameter detail

4.1.5 Disallow control from remote controller

This parameter allows:

- 1- Having the remote controller always locked, or
 - 2- Decide through a new communication object if the RC is locked or not.
- If set to **"Yes"** all the actions performed through the remote controller will be disabled.
 - If set to **"No"** the remote controller will work as usually. It also appears a new parameter and the communication object *Control_ Lock Remote Control*.

28 Control_ Lock Remote Control [DPT_1.002 - 1bit] - 0-Unlock;1-Lock

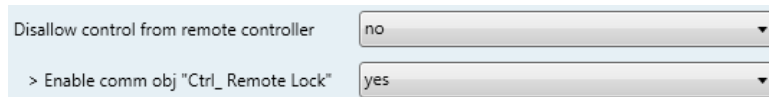

Figure 4.5 Communication object and parameter detail

➤ Enable comm obj "Ctrl_ Remote Lock":

If set to **"No"** the object will not be shown.

If set to **"Yes"** the *Control_ Lock Remote Control* object will appear.

- When a **"1"** value is sent to this communication object, the remote controller is locked. To be unlocked a **"0"** value must be sent. The gateway remembers the last value received even if a KNX bus reset/failure happens.

⚠ **Important:** *If an initial scene is enabled and it has as Value for Remote Lock (unchanged) or unlocked, this would unlock the remote controller because the initial scene has priority over the Control_ Lock Remote Control communication object.*

4.1.6 Enable func "Control_ Lock Control Obj"

This parameter shows/hide the *Control_ Lock Control Obj* communication object which, depending on the sent value, locks or unlocks ALL the *Control_* communication objects except itself.

■ ↕ 29 Control_Lock Control Objects [DPT_1.002 - 1bit] - 0-Unlock;1-Lock

- If set to **"No"** the object will not be shown.
- If set to **"Yes"** the *Control_Lock Control Objects* object will appear.
 - When a **"1"** value is sent to this communication object, all the *Control_* objects will be locked. To unlock a **"0"** value must be sent, as the gateway remembers the last value received even if a KNX bus reset/failure happens.

4.1.7 Enable func "Operating Time Counter"

This parameter shows/hides the *Status_ Operation Hour Counter* and *Status_ Operation Sec Counter* communication objects which counts the number of operating hours or seconds for the INKNXLGE001R000.

- If set to **"No"** objects will not be shown.
- If set to **"Yes"** the *Status_ Operation Sec Counter* object and an additional parameter for the *Status_ Operation Hour Counter* selection will appear.

Enable func "Operating Time Counter"	Yes
> Enable object "Oper. Hour Counter"	Yes

■ ↕ 81 Status_ Operation Hour Counter [DPT_7.001 - 2byte] - Number of operating hours

■ ↕ 82 Status_ Operating Sec Counter [DPT_13.100 - 4byte] - Number of operating seconds

- These objects can be read and sends its status every time an hour/second is counted. The gateway keeps that count in memory and the status is sent also after a KNX bus reset/failure. Although this object is marked as a *Status_* object it also can be written to update the counter when needed. To reset the counter should be written a **"0"** value.
- ⚠ **Important:** This object comes by default without the write (**W**) flag activated. If is necessary to write on it, this flag must be activated.
- ⚠ **Important:** This object will also return its status, every time a value is written, only if it's different from the existing one.
- ⚠ **Important:** If the stored value is 0 hours, the gateway will not send the status to KNX.

4.1.8 Enable object "Error Code [2byte]"

This parameter shows/hides the *Status_ Error Code* communication object which shows the indoor unit errors, if occurred, in numeric format.

■ ↕ 73 Status_ Error Code [2byte] - 0-No error /Any other see man.

- If set to **"No"** the object will not be shown.
- If set to **"Yes"** the *Status_ Error Code [2byte]* object will appear.
 - This object can be read and also sends the indoor unit error, if occurred, in numeric format. If a **"0"** value is shown that means no error.

4.1.9 Enable object "Error Text Code [14byte]"

This parameter shows/hides the *Status_ Error Text Code* communication object which shows the indoor unit errors, if occurred, in text format.

➡ 74 Status_ Error Text Code [DPT_16.001 - 14byte] - 3-char PA Error; Empty-None

- If set to **"No"** the object will not be shown.
- If set to **"Yes"** the *Status_ Error Text Code* object will appear.
 - This object can be read and also sends the indoor unit error, if occurred, in text format. The errors shown have the same format as at the remote controller and at the error list from the indoor unit manufacturer. If the object's value is empty that means no error.

4.2 Mode Configuration dialog

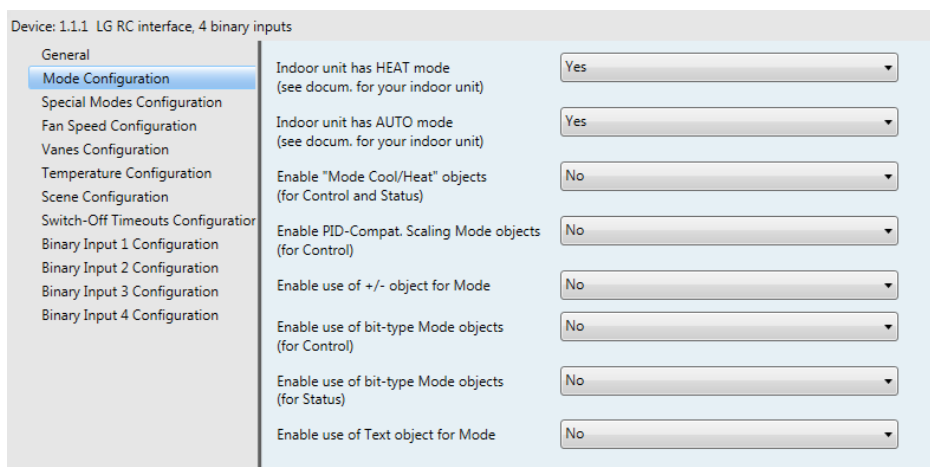

Figure 4.6 Default Mode Configuration dialog

All the parameters in this section are related with the different mode properties and communication objects.

➡ 1 Control_Mode [DPT_20.105 - 1byte] - 0-Aut;1-Hea;3-Coo;9-Fan;14-Dry

The byte-type communication object for Mode works with the DTP_20.105. Auto mode will be enabled with a **"0"** value, Heat mode with a **"1"** value, Cool mode with a **"3"** value, Fan mode with a **"9"** value and Dry mode with a **"14"** value.

4.2.1 Indoor unit has HEAT mode

This parameter has to be used to indicate if the indoor unit has the *heat mode* available.

- If set to **"No"**, the indoor unit doesn't have the *heat mode* available.
- If set to **"Yes"**, the indoor unit has the *heat mode* available.

⚠ **Important:** Read the documentation of your indoor unit to check if it has HEAT mode available.

4.2.2 Indoor unit has AUTO mode

This parameter has to be used to indicate if the indoor unit has the *auto mode* available.

- If set to **"No"**, the indoor unit doesn't have the *auto mode* available.
- If set to **"Yes"**, the indoor unit has the *auto mode* available.

Important: Read the documentation of your indoor unit to check if it has AUTO mode available.

4.2.3 Enable "Mode Cool/Heat" objects

This parameter shows/hides the *Control_ Mode Cool/Heat* and *Status_ Mode Cool/Heat* communication objects.

- ➡ 2 Control_ Mode Cool/Heat [DPT_1.100 - 1bit] - 0-Cool;1-Heat
- ➡ 54 Status_ Mode Cool/Heat [DPT_1.100 - 1bit] - 0-Cool;1-Heat

- If set to **"No"** the objects will not be shown.
- If set to **"Yes"** the *Control_ Mode Cool/Heat* and *Status_ Mode Cool/Heat* objects will appear.
 - When a **"1"** value is sent to the *Control_ Mode Cool/Heat* communication object, **Heat mode** will be enabled in the indoor unit, and the *Status_ Mode Cool/Heat* object will return this value.
 - When a **"0"** value is sent to the *Control_ Mode Cool/Heat* communication object, **Cool mode** will be enabled in the indoor unit, and the *Status_ Mode Cool/Heat* object will return this value.

4.2.4 Enable PID-Compat. Scaling Mode Objects (for Control)

This parameter shows/hides the *Control_ Mode Cool & On* and *Control_ Mode Heat & On* communication objects.

- ➡ 3 Control_ Mode Cool & On [DPT_5.001 - 1byte] - 0%-Off;0.1%-100%-On+Cool
- ➡ 4 Control_ Mode Heat & On [DPT_5.001 - 1byte] - 0%-Off;0.1%-100%-On+Heat

- If set to **"No"** the objects will not be shown.

- If set to **"Yes"** the *Control_ Mode Cool & On* and *Control_ Mode Heat & On* objects will appear.
 - These objects provide compatibility with those KNX thermostats that control the demand of heating or cooling by using scaling (percentage) objects. In these thermostats, the percentage demand is meant to be applied on a fluid valve of the heating / cooling system.
 - INKNXLGE001R000 device does not provide individual control on the internal parts of the indoor unit (as can be its compressor, refrigerant valves, etc.). Rather, it provides the same level of control as a (user) remote controller.
 - Objects "Control_ Mode Cool & On" and "Control_ Mode Heat & On" intend to bring compatibility between thermostats oriented to the control of custom heating / cooling systems and ready-made AC indoor units, by applying the following logic:
 - Whenever a non-zero value (>0%) is received at "Control_ Mode Cool & On", indoor unit will switch On in COOL mode.
 - Whenever a non-zero value (>0%) is received at "Control_ Mode Heat & On", indoor unit will switch On in HEAT mode.
 - Latest updated object will define the operating mode
 - Indoor unit will switch off only when both objects become zero (0%) – or when an OFF is requested at object "0. On/Off [DPT_1.001 - 1bit]"
- * **Important:** These objects function is only to send On/Off and Cool/Heat to the indoor unit. The PID (Inverter system) is calculated by the indoor unit itself. Please consider introducing an appropriate PID configuration to the external KNX thermostat to not interfere the indoor unit PID.

4.2.5 Enable use of + / - object for Mode

This parameter shows/hides the *Control_ Mode +/-* communication object which lets change the indoor unit mode by using two different datapoint types.

 10 Control_ Mode +/- [DPT_1.007 - 1bit] - 0-Decrease;1-Increase

- If set to **"No"** the object will not be shown.
- If set to **"Yes"** the *Control_ Mode +/-* object and a new parameter will appear.

Enable use of +/- object for Mode	yes
> DPT type for +/- Mode Object	0-Up / 1-Down [DPT_1.008]

Figure 4.7 Parameter detail

➤ DPT type for +/- Mode Object

This parameter lets choose between the datapoints **0-Up / 1-Down [DPT_1.008]** and **0-Decrease / 1-Increase [DPT_1.007]** for the *Control_ Mode +/-* object.

The sequence followed when using this object is shown below:



- Up / Increase
- Down / Decrease
- * If available

⚠ **Important:** Read the documentation of your indoor unit to check if it has HEAT mode available.

4.2.6 Enable use of bit-type Mode objects (for control)

This parameter shows/hides the bit-type *Control_ Mode* objects.

- ↕ 5 Control_ Mode Auto [DPT_1.002 - 1bit] - 1-Set AUTO mode
- ↕ 6 Control_ Mode Heat [DPT_1.002 - 1bit] - 1-Set HEAT mode
- ↕ 7 Control_ Mode Cool [DPT_1.002 - 1bit] - 1-Set COOL mode
- ↕ 8 Control_ Mode Fan [DPT_1.002 - 1bit] - 1-Set FAN mode
- ↕ 9 Control_ Mode Dry [DPT_1.002 - 1bit] - 1-Set DRY mode

- If set to **"No"** the objects will not be shown.
- If set to **"Yes"** the *Control_ Mode* objects for Auto, Heat, Cool, Fan and Dry will appear. To activate a mode by using these objects a **"1"** value has to be sent.

4.2.7 Enable use of bit-type Mode objects (for status)

This parameter shows/hides the bit-type *Status_ Mode* objects.

- ↕ 53 Status_ Mode Auto [DPT_1.002 - 1bit] - 1-AUTO mode is active
- ↕ 54 Status_ Mode Heat [DPT_1.002 - 1bit] - 1-HEAT mode is active
- ↕ 55 Status_ Mode Cool [DPT_1.002 - 1bit] - 1-COOL mode is active
- ↕ 56 Status_ Mode Fan [DPT_1.002 - 1bit] - 1-FAN mode is active
- ↕ 57 Status_ Mode Dry [DPT_1.002 - 1bit] - 1-DRY mode is active

- If set to **"No"** the objects will not be shown.
- If set to **"Yes"** the *Status_ Mode* objects for Auto, Heat, Cool, Fan and Dry will appear. When enabled, a mode will return a **"1"** through its bit-type object.

4.2.8 Enable use of Text object for Mode

This parameter shows/hides the *Status_ Mode Text* communication object.

- ↕ 58 Status_ Mode Text [DPT_16.001 - 14byte] - ASCII String

- If set to **"No"** the object will not be shown.
- If set to **"Yes"** the *Status_ Mode Text* object will appear. Also, in the parameters, will be shown five text fields, one for each mode, that will let modify the text string displayed by the *Status_ Mode Text* when changing mode.

> String when mode is AUTO	AUTO
> String when mode is HEAT (if available)	HEAT
> String when mode is COOL	COOL
> String when mode is FAN	FAN
> String when mode is DRY	DRY

Figure 4.8 Parameter detail

4.3 Special Modes Configuration dialog

Device: 1.1.1 LG RC interface, 4 binary inputs

- General
- Mode Configuration
- Special Modes Configuration
- Fan Speed Configuration
- Vanes Configuration
- Temperature Configuration
- Scene Configuration
- Switch-Off Timeouts Configuration
- Binary Input 1 Configuration
- Binary Input 2 Configuration
- Binary Input 3 Configuration
- Binary Input 4 Configuration

Enable use of POWER mode: No

Enable use of ECONOMY mode: No

Enable use of ADDITIONAL HEATING mode: No

Enable use of ADDITIONAL COOLING mode: No

Figure 4.9 Default Special Modes Configuration dialog

The Special Modes can be parameterized through the ETS parameters dialog, and they can be used to give extra functionality.

- ⚠ **Important:** When executing any of the Special Modes the real state of the indoor unit will NOT be shown in KNX.
- ⚠ **Important:** When the predefined time for the Special Mode is finished or a **"0"** value is sent to stop it; the previous state will be recovered.
- ⚠ **Important:** If a value concerning On/Off, Mode, Fan Speed or Setpoint Temperature is received from KNX while any Special Mode is running (**"1"**), the Special Mode will stop and the previous state will be recovered. The value received will be also applied then.
- ⚠ **Important:** If a value concerning On/Off, Mode, Fan Speed or Setpoint Temperature is modified through the remote controller, the Special Mode will stop WITHOUT recovering the previous state. Then the real indoor unit state will be shown in KNX including the new value received through the remote controller.

4.3.1 Enable use of POWER mode

This parameter shows/hides the *Control_ Power Mode* and *Status_ Power Mode* communication objects. The Power Mode lets change the Setpoint Temperature and the Fan Speed within a given period of time.

- ↕ 30 Control_ Power Mode [DPT_1.010 - 1bit] - 0-Stop;1-Start
- ↕ 77 Status_ Power Mode [DPT_1.001 - 1bit] - 0-Off;1-On

- If set to **"No"** the objects will not be shown.
- If set to **"Yes"** the *Control_ Power Mode* and *Status_ Power Mode* objects and new parameters will appear.

Figure 4.10 Parameter detail

- When a **"1"** value is sent to the *Control_* communication object Power Mode will be enabled, and the *Status_* object will return this value.
- When a **"0"** value is sent to the *Control_* communication object, Power Mode will be disabled, and the *Status_* object will return this value.

⚠ **Important:** This mode will *ONLY* work if the indoor unit is both turned on and in a Heat, Cool, Auto-Heat or Auto-Cool Mode.

➤ Action time for this mode (minutes):

Duration of Power Mode, in minutes, once started.

➤ Setpoint delta increase (HEAT) or decrease (COOL) – in Celsius:

Number of degrees Celsius that will increase in Heat Mode, or decrease in Cool Mode, while in Power Mode.

➤ Fan Speed for this mode:

Fan Speed that will be set in the unit while in Power Mode.

4.3.2 Enable use of ECONOMY mode

This parameter shows/hides the *Control_ Econo Mode* and *Status_ Econo Mode* communication objects. The Econo Mode lets change the Setpoint Temperature and the Fan Speed within a given period of time.

- ↕ 31 Control_ Econo Mode [DPT_1.010 - 1bit] - 0-Stop;1-Start
- ↕ 78 Status_ Econo Mode [DPT_1.001 - 1bit] - 0-Off;1-On

- If set to **"No"** the objects will not be shown.
- If set to **"Yes"** the *Control_ Econo Mode* and *Status_ Econo Mode* objects and new parameters will appear.
 - When a **"1"** value is sent to the *Control_* communication object, EconoMode will be enabled, and the *Status_* object will return this value.
 - When a **"0"** value is sent to the *Control_* communication object, EconoMode will be disabled, and the *Status_* object will return this value.
- ⚠ **Important:** *This mode will ONLY work if the indoor unit is both turned on and in a Heat, Cool, Auto-Heat or Auto-Cool Mode.*
- Action time for this mode (minutes):

Duration of EconoMode, in minutes, once started.
- Setpoint delta increase (HEAT) or decrease (COOL) – in Celsius:

Number of degrees Celsius that will increase in Heat Mode, or decrease in Cool Mode, while in EconoMode.
- Fan Speed for this mode:

Fan Speed that will be set in the unit while in EconoMode.

4.3.3 Enable use of ADDITIONAL HEATING mode

This parameter shows/hides the *Control_ Start Additional Heat Mode* and *Status_ Additional Heat Mode* communication objects. The Additional Heating Mode lets change the Setpoint Temperature and the Fan Speed within a given period of time.

- 32 Control_ Additional Heat [DPT_1.010 - 1bit] - 0-Stop;1-Start
- 79 Status_ Additional Heat [DPT_1.001 - 1bit] - 0-Off;1-On

- If set to **"No"** the objects will not be shown.
- If set to **"Yes"** the *Control_ Start Additional Heat Mode* and *Status_ Additional Heat Mode* objects and new parameters will appear.
 - When a **"1"** value is sent to the *Control_* communication object, Additional Heating Mode will be enabled, and the *Status_* object will return this value.
 - When a **"0"** value is sent to the *Control_* communication object, Additional Heating Mode will be disabled, and the *Status_* object will return this value.
- ⚠ **Important:** *This mode will ALWAYS turn on the indoor unit in Heat mode.*
- Action time for this mode (minutes):

Duration of Additional Heating Mode, in minutes, once started.

➤ Setpoint temp for this mode (°C):

Setpoint temperature that will be applied while in Additional Heating Mode.

➤ Fan Speed for this mode:

Fan Speed that will be set in the unit while in Additional Heating Mode.

4.3.4 Enable use of ADDITIONAL COOLING mode

This parameter shows/hides the *Control_ Start Additional Cool Mode* and *Status_ Additional Cool Mode* communication objects. The Additional Heating Mode lets change the Setpoint Temperature and the Fan Speed within a given period of time.

- ↕ 33 Control_ Additional Cool [DPT_1.010 - 1bit] - 0-Stop;1-Start
- ↕ 80 Status_ Additional Cool [DPT_1.001 - 1bit] - 0-Off;1-On

- If set to **"No"** the objects will not be shown.
- If set to **"Yes"** the Control_ Start Additional Cool Mode and Status_ Additional Cool Mode objects and new parameters will appear.
 - When a **"1"** value is sent to the *Control_* communication object, Additional Cooling Mode will be enabled, and the *Status_* object will return this value.
 - When a **"0"** value is sent to the *Control_* communication object, Additional Cooling Mode will be disabled, and the *Status_* object will return this value.

⚠ **Important:** This mode will ALWAYS turn on the indoor unit in Cool mode.

➤ Action time for this mode (minutes):

Duration of Additional Cooling Mode, in minutes, once started.

➤ Setpoint temp for this mode (°C):

Setpoint temperature that will be applied while in Additional Cooling Mode.

➤ Fan Speed for this mode:

Fan Speed that will be set in the unit while in Additional Cooling Mode.

4.4 Fan Speed Configuration dialog

Device: 1.1.1 LG RC interface, 4 binary inputs

General	Available fanspeeds in Indoor Unit (see docum. for your indoor unit)	4
Mode Configuration	Indoor unit has AUTO fan speed (see docum. for your indoor unit)	Yes
Special Modes Configuration	DPT object type for fanspeed	Scaling [DPT_5.001]
Fan Speed Configuration	Enable use of +/- object for Fan Speed	No
Vanes Configuration	Enable "Fan Speed Man/Auto" objects (for Control and Status)	No
Temperature Configuration	Enable use of bit-type Fan Speed objects (for Control)	No
Scene Configuration	Enable use of bit-type Fan Speed objects (for Status)	No
Switch-Off Timeouts Configuration	Enable use of Text object for Fan Speed	No
Binary Input 1 Configuration		
Binary Input 2 Configuration		
Binary Input 3 Configuration		
Binary Input 4 Configuration		

Figure 4.11 Default Fan Speed Configuration dialog

All the parameters in this section are related with the Fan Speed properties and communication objects.

4.4.1 Available fanspeeds in Indoor Unit

With this parameter you select the number of fan speeds available in your indoor unit. Please check that information in your indoor unit manual.

4.4.2 Indoor unit has AUTO fan speed

With this parameter you select if your indoor unit has or not AUTO fan speed mode. Please check that information in your indoor unit manual.

4.4.3 DPT object type for Fan Speed

With this parameter is possible to change de DPT for the *Control_Fan Speed* and *Status_Fan Speed* byte-type communication objects. Datapoints Scaling (DPT_5.001) and Enumerated (DPT_5.010) can be selected.

⚠ Important: The communication objects shown in this section may be different depending on the number of fan speeds available, although they all share the same communication object number.

- When **"Enumerated [DPT 5.010]"** is selected, *Control_Fan Speed* and *Status_Fan Speed* communication objects for this DPT will appear.

- ➡ 11 *Control_Fan Speed / 3 Speeds [DPT_5.010 - 1byte]* - Speed values: 1,2,3
- ➡ 59 *Status_Fan Speed / 3 Speeds [DPT_5.010 - 1byte]* - Speed Values: 1,2,3

The first fan speed will be selected if a **"1"** is sent to the *Control_* object. The second one will be selected sending a **"2"**; the third one will be selected sending a **"3"**.

The *Status_* object will always return the value for the fan speed selected.

⚠ Important: If a "0" value is sent to the *Control_* object, the minimum fan speed will be selected. If a value bigger than "3" is sent to the *Control_* object, then the maximum fan speed will be selected.

- When "Scaling [DPT 5.001]" is selected, *Control_ Fan Speed* and *Status_ Fan Speed* communication objects for this DPT will appear.

- ↕ 11 *Control_ Fan Speed / 3 Speeds* [DPT_5.001 - 1byte] - Thresholds: 50% and 83%
- ↕ 63 *Status_ Fan Speed / 3 Speeds* [DPT_5.001 - 1byte] - 33%, 67% and 100%

The next table shows the range of values that can be sent through the *Control_* object and the value returned by the *Status_* object.

	Fan Speed 1	Fan Speed 2	Fan Speed 3
<i>Control_</i>	0% - 49%	50% - 82%	83% - 100%
<i>Status_</i>	33%	67%	100%

⚠ Important: Read the documentation of your indoor unit to check how many fan speeds are available.

4.4.4 Enable use of +/- object for Fan Speed

This parameter shows/hides the *Control_ Fan Speed +/-* communication object which lets increase/decrease the indoor unit fan speed by using two different datapoint types.

- ↕ 17 *Control_ Fan Speed +/-* [DPT_1.007 - 1bit] - 0-Decrease;1-Increase

- If set to "No" the object will not be shown.
- If set to "Yes" the *Control_ Fan Speed +/-* object and a new parameter will appear.

Figure 4.13 Parameter detail

➤ DPT type for +/- Fan Speed Object

This parameter lets choose between the datapoints **0-Up / 1-Down [DPT_1.008]** and **0-Decrease / 1-Increase [DPT_1.007]** for the *Control_ Fan Speed +/-* object.

➤ Does +/- sequence include fan speed Auto?

This parameter includes or excludes the auto mode for the fan speed in the list of available speeds.

➤ Roll-over Speed at upper/lower limit

This parameter lets choose if roll-over will be enabled (“**Yes**”) or disabled (“**No**”) for the *Control_ Fan Speed +/-* object.

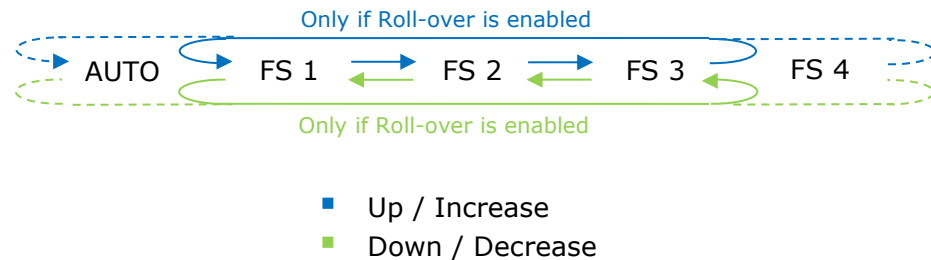

4.4.5 Enable “Fan Speed Man/Auto” objects (for Control and Status)

This parameter shows/hides the bit-type *Control_ Fan Speed Man/Auto* and the *Status_ Fan Speed Man/Auto* objects.

- 12 Control_ Fan Speed Man/Auto [DPT_1.002 - 1bit] - 0-Manual; 1-Auto
- 60 Status_ Fan Speed Man/Auto [DPT_1.002 - 1bit] - 0-Manual;1-Auto

4.4.6 Enable use of bit-type Fan Speed objects (for Control)

This parameter shows/hides the bit-type *Control_ Fan Speed* objects.

- 13 Control_ Fan Speed 1 [DPT_1.002 - 1bit] - 1-Set Fan Speed 1
- 14 Control_ Fan Speed 2 [DPT_1.002 - 1bit] - 1-Set Fan Speed 2
- 15 Control_ Fan Speed 3 [DPT_1.002 - 1bit] - 1-Set Fan Speed 3
- 16 Control_ Fan Speed 4 [DPT_1.002 - 1bit] - 1-Set Fan Speed 4

- If set to “**No**” the objects will not be shown.
- If set to “**Yes**” the *Control_ Fan Speed* objects for Speed 1, Speed 2 and Speed 3 will appear. To activate a Fan Speed by using these objects a “**1**” value has to be sent.

4.4.7 Enable use of bit-type Fan Speed objects (for Status)

This parameter shows/hides the bit-type *Status_ Fan Speed* objects.

- 61 Status_ Fan Speed 1 [DPT_1.002 - 1bit] - 1-Fan in Speed 1
- 62 Status_ Fan Speed 2 [DPT_1.002 - 1bit] - 1-Fan in Speed 2
- 63 Status_ Fan Speed 3 [DPT_1.002 - 1bit] - 1-Fan in Speed 3
- 64 Status_ Fan Speed 4 [DPT_1.002 - 1bit] - 1-Fan in speed 4

- If set to “**No**” the objects will not be shown.
- If set to “**Yes**” the *Status_ Fan Speed* objects for Speed 1, Speed 2 and Speed 3 will appear. When a Fan Speed is enabled, a “**1**” value is returned through its bit-type object.

4.4.8 Enable use of Text object for Fan Speed

This parameter shows/hides the *Status_ Fan Speed Text* communication object.

↔ 65 Status_ Fan Speed Text [DPT_16.001 - 14byte] - ASCII String

- If set to **"No"** the object will not be shown.
- If set to **"Yes"** the *Status_ Fan Speed Text* object will appear. Also, in the parameters, will be shown five text fields, one for each Fan Speed, that will let modify the text string displayed by the *Status_ Fan Speed Text* when changing a fan speed.

> String when fan speed is AUTO	AUTO
> String when fan speed is 1	SPEED 1
> String when fan speed is 2	SPEED 2
> String when fan speed is 3	SPEED 3

Figure 4.14 Parameter detail

4.5 Vanes Up-Down Configuration dialog

Device: 1.1.1 LG RC interface, 4 binary inputs

General	Indoor unit has U-D Vanes (see docum. for your indoor unit)	Yes
Mode Configuration	Indoor unit has Vanes Swirl (see docum. for your indoor unit)	Yes
Special Modes Configuration	Indoor unit has L-R Vanes (see docum. for your indoor unit)	Yes
Fan Speed Configuration	Indoor unit has Vanes Swirl (see docum. for your indoor unit)	Yes
Vanes Configuration		
Temperature Configuration		
Scene Configuration		
Switch-Off Timeouts Configuration		
Binary Input 1 Configuration		
Binary Input 2 Configuration		
Binary Input 3 Configuration		
Binary Input 4 Configuration		

Figure 4.15 Vanes Up-Down Configuration dialog

All the parameters in this section are related with the Vanes Up-Down/Left-Right properties and communication objects.

4.5.1 Indoor unit has U-D Vanes

This parameter lets choose if the unit has Up-Down Vanes available or not.

Indoor unit has U-D Vanes (see docum. for your indoor unit)	Yes
--	-----

Figure 4.16 Parameter detail

- If set to **"No"** all the parameters and communication objects for the Up-Down Vanes will not be shown.

- If set to **"Yes"** all the parameters and communication objects (if enabled in the parameters dialog) for the Up-Down Vanes will be shown.

- ↕ 18 Control_Vanes U-D Swing [DPT_1.002 - 1bit] - 0-Off;1-Swing
- ↕ 66 Status_Vanes U-D Swing [DPT_1.002 - 1bit] - 0-Off;1-Swing

⚠ **Important:** Read the documentation of your indoor unit to check if Up-Down Vanes are available.

4.5.2 Indoor unit has Vanes Swirl (for U-D vanes)

This parameter lets choose if the unit has Swirl mode available or not.

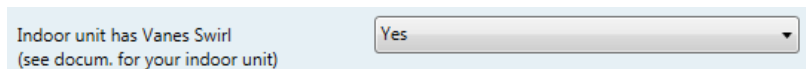

Indoor unit has Vanes Swirl
(see docum. for your indoor unit) Yes

Figure 4.16 Parameter detail

- If set to **"No"** all the parameters and communication objects for the Up-Down Swirl Vanes will not be shown.
- If set to **"Yes"** all the parameters and communication objects (if enabled in the parameters dialog) for the Up-Down Swirl Vanes will be shown.

- ↕ 19 Control_Vanes U-D Swirl [DPT_1.002 - 1bit] - 0-Off;1-Swirl
- ↕ 67 Status_Vanes U-D Swirl [DPT_1.002 - 1bit] - 0-Off;1-Swirl

⚠ **Important:** Read the documentation of your indoor unit to check if Swirl mode is available.

4.5.3 Indoor unit has L-R Vanes

This parameter lets choose if the unit has Up-Down Vanes available or not.

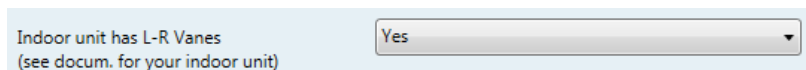

Indoor unit has L-R Vanes
(see docum. for your indoor unit) Yes

Figure 4.16 Parameter detail

- If set to **"No"** all the parameters and communication objects for the Up-Down Vanes will not be shown.
- If set to **"Yes"** all the parameters and communication objects (if enabled in the parameters dialog) for the Up-Down Vanes will be shown.

- ↕ 20 Control_Vanes L-R Swing [DPT_1.002 - 1bit] - 0-Off;1-Swing
- ↕ 68 Status_Vanes L-R Swing [DPT_1.002 - 1bit] - 0-Off;1-Swing

⚠ Important: Read the documentation of your indoor unit to check if Up-Down Vanes are available.

4.5.4 Indoor unit has Vanes Swirl (for U-D vanes)

This parameter lets choose if the unit has Swirl mode available or not.

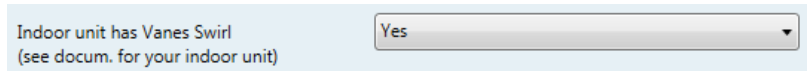

Figure 4.16 Parameter detail

- If set to **"No"** all the parameters and communication objects for the Left-Right Swirl Vanes will not be shown.
- If set to **"Yes"** all the parameters and communication objects (if enabled in the parameters dialog) for the Up-Down Swirl Vanes will be shown.

- 21 Control_Vanes L-R Swirl [DPT_1.002 - 1bit] - 0-Off;1-Swirl
- 69 Status_Vanes L-R Swirl [DPT_1.002 - 1bit] - 0-Off;1-Swirl

⚠ Important: Read the documentation of your indoor unit to check if Swirl mode is available.

4.6 Temperature Configuration dialog

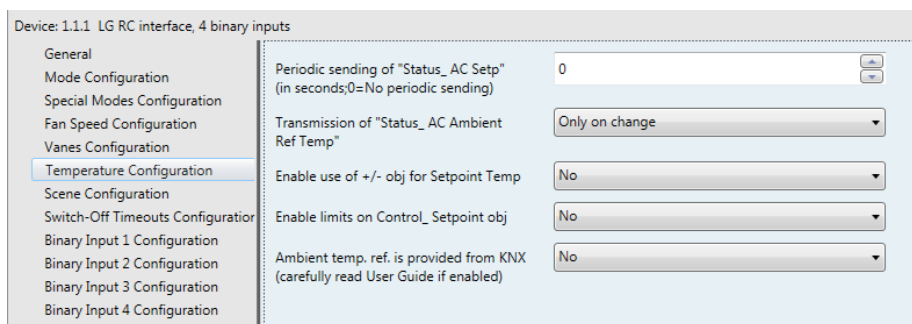

Figure 4.20 Default Temperature Configuration dialog

All the parameters in this section are related with the Temperature properties and communication objects.

4.6.1 Periodic sending of "Status_ AC Setp"

This parameter lets change the interval of time (in seconds, from 0 to 255) at the end of which the AC setpoint temperature is sent to the KNX bus. For a **"0"** value, the AC setpoint temperature will **ONLY** be sent on change. The AC setpoint temperature is sent through the communication object *Status_ AC Setpoint Temp*.

70 Status_ AC Setpoint Temp [DPT_9.001 - 2byte] - (°C)

Periodic sending of "Status_ AC Setp" (in seconds; 0 = No periodic sending) 255

Figure 4.21 Parameter detail

⚠ Important: In case the ambient temperature is provided from KNX, the setpoint temperature returned from this object, will be the one resulting from the formula shown in the section "4.6.4 Ambient temp. ref. is provided from KNX".

4.6.2 Transmission of "Status_ AC Ref Temp"

This parameter lets to you choose if the AC return temperature will be sent **"only cyclically"**, **"only on change"** or **"cyclically and on change"**. The AC return temperature is sent through the communication object *Status_ AC Ref Temp*.

71: Status_ AC Ambient Ref Temp [DPT_9.001 - 2byte] - °C

Transmission of "Status_ AC Return Temp" Cyclically and on change

> "Status_ AC Return Temp" periodic sending time (in sec) 180

Figure 4.22 Parameter detail

➤ "Status_ AC SetTemp" periodic sending time (in sec)

This parameter will only be available for the **"only cyclically"** and **"cyclically and on change"** options, and lets you change the interval of time (in seconds, from 1 to 255) at the end of which the AC return temperature is sent to the KNX bus.

4.6.3 Enable use of +/- object for Setpoint Temp

This parameter shows/hides the *Control_ Setpoint Temp +/-* communication object which lets change the indoor unit setpoint temperature by using two different datapoint types.

22 Control_ Setpoint Temp +/- [DPT_1.007 - 1bit] - 0-Decrease;1-Increase

- If set to **"No"** the object will not be shown.
- If set to **"Yes"** the *Control_ Setpoint Temp +/-* object and a new parameter will appear.





Enable use of +/- obj for Setp Temp yes

> DPT type for +/- Setp Temp object 0-Up / 1-Down [DPT_1.008]

Figure 4.22 Parameter detail

➤ DPT type for +/- Setp Temp object

This parameter lets choose between the datapoints **0-Up / 1-Down [DPT_1.008]** and **0-Decrease / 1-Increase [DPT_1.007]** for the *Control_ Setpoint Temp +/-* object.

(Lower limit) **16°C**  19°C  ...  28°C  **30°C** (Upper limit)

- Up / Increase
- Down / Decrease

4.6.4 Enable limits on Control_ Setpoint obj

This parameter enables to define temperature limits for the *Control_ Setpoint Temperature* object.

Enable limits on Control_ Setpoint obj	Yes
> Lower limit (°C)	18.0 °C
> Upper limit (°C)	27.0 °C

Figure 4.23 Parameter detail

- If set to **"No"** the setpoint temperature limits for the *Control_ Setpoint Temperature* object will be the default: 16°C for the lower limit and 30°C for the upper limit.
- If set to **"Yes"** it is possible to define temperature limits for the *Control_ Setpoint Temperature* object.

➤ Control_ Set Temp Lower limit (°C)

This parameter lets to define the lower limit for the setpoint temperature.

➤ Control_ Set Temp Upper limit (°C)

This parameter lets to define the upper limit for the setpoint temperature.

⚠ **Important:** If a setpoint temperature above the upper defined limit (or below the lower defined limit) is sent through the *Control_ Setpoint Temperature* object, it will be ALWAYS applied the limit defined.

⚠ **Important:** When limits are enabled, any setpoint temperature sent to the AC (even through scenes, special modes, etc.) will be limited.

4.6.5 Ambient temp. ref. is provided from KNX

This parameter shows/hides the *Control_ Ambient Temperature* communication object which lets use an ambient temperature reference provided by a KNX device.

24 Control_Ambient Temperature [DPT_9.001 - 2byte] - (°C)

- If set to **"No"** the object will not be shown.
- If set to **"Yes"** the *Control_Ambient Temperature* object will appear. Meant to be enabled when you want the temperature provided by a KNX sensor to be the reference ambient temperature for the air conditioner. Then, the following formula applies for calculation of real *Control_Setpoint Temperature* sent to the AC unit:

$$\text{"AC Setp. Temp"} = \text{"AC Ret. Temp"} - (\text{"KNX Amb. Temp."} - \text{"KNX Setp. Temp"})$$

- AC Setp. Temp: AC indoor unit setpoint temperature
- AC Ret. Temp: AC indoor unit return temperature
- KNX Amb. Temp.: Ambient temperature provided from KNX
- KNX Setp. Temp: Setpoint temperature provided from KNX

As an example, consider the following situation:

User wants: **19°C** ("KNX Setp. Temp.")

User sensor (a KNX sensor) reads: **21°C** ("KNX Amb Temp.")

Ambient temp. read by LG system is: **24°C** ("AC Ret. Temp")

In this example, the final setpoint temperature that INKNXLGE001R000 will send out to the indoor unit (shown in "Setp. Temp.") will become $24^{\circ}\text{C} - (21^{\circ}\text{C} - 19^{\circ}\text{C}) = \mathbf{22^{\circ}\text{C}}$. This is the setpoint that will actually be requested to LG unit.

This formula will be applied as soon as the *Control_Setpoint Temperature* and *Control_Ambient Temperature* objects are written at least once from the KNX installation. After that, they are kept always consistent.

Note that this formula will always drive the AC indoor unit demand in the *right* direction, regardless of the operation mode (Heat, Cool or Auto).

4.7 Scene Configuration dialog

Device: 1.1.1 LG RC interface, 4 binary inputs

General	Enable use of scenes	Yes
Mode Configuration	Scenes can be stored from KNX bus	No
Special Modes Configuration	Enable use of bit objects for scene execution	No
Fan Speed Configuration	Scene 1 preset	No
Vanes Configuration	Scene 2 preset	No
Temperature Configuration	Scene 3 preset	No
Scene Configuration	Scene 4 preset	No
Switch-Off Timeouts Configuration	Scene 5 preset	No
Binary Input 1 Configuration		
Binary Input 2 Configuration		
Binary Input 3 Configuration		
Binary Input 4 Configuration		

Figure 4.24 Parameter detail

All the parameters in this section are related with the Scene properties and communication objects. A scene contains values of: On/Off, Mode, Fan speed, Vane position, Setpoint Temperature and Remote Controller Disablement.

4.7.1 Enable use of scenes

This parameter shows/hides the scene configuration parameters and communication objects.

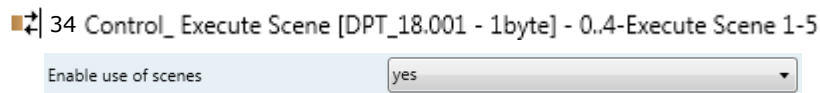

Figure 4.25 Parameter detail

- If set to **"No"** the scene parameters and communication objects will not be shown.
- If set to **"Yes"** the scene parameters and communication objects will be shown. To execute a scene through the byte-type object, a value from **"0"** to **"4"** has to be sent, corresponding each one to a different scene (i.e. "0" = Scene 1;... "4" = Scene 5).

4.7.2 Scenes can be stored from KNX bus

This parameter shows/hides the *Control_ Save/Exec Scene* and all the *Control_ Store Scene* (if enabled) communication objects.



- If set to **"No"** the communication objects will not be shown.
- If set to **"Yes"** the communication objects and a new parameter will appear. To store a scene through the byte-type object, a value from **"128"** to **"132"** has to be sent to the object, corresponding each one to a different scene (i.e. "128" = Scene 1;... "132" = Scene 5).

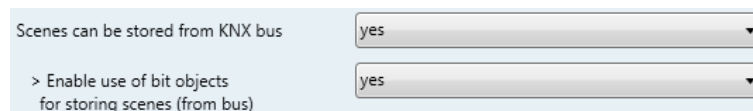
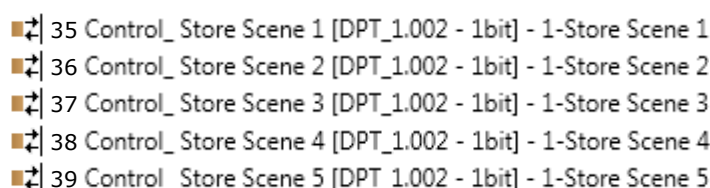

Figure 4.26 Parameter detail

➤ Enable use of bit objects for storing scenes (from bus)

If set to **"No"** the objects will not be shown.

If set to **"Yes"** the *Control_ Store Scene* objects for storing scenes will appear. To store a scene by using these objects, a **"1"** value has to be sent to the scene's object we want to store (i.e. to store scene 4, a "1" has to be sent to the *Control_ Store Scene 4* object).



4.7.3 Enable use of bit objects for scene execution

This parameter shows/hides the *Control_ Execute Scene* bit-type communication objects.

Figure 4.27 Parameter detail

- If set to **"No"** the communication objects will not be shown.
- If set to **"Yes"** the communication objects will appear. To execute a scene by using these objects, a **"1"** value has to be sent to the scene's object we want to execute (i.e. to execute scene 4, a "1" has to be sent to the *Control_ Execute Scene 4* object).

- 40 Control_ Execute Scene 1 [DPT_1.002 - 1bit] - 1-Execute Scene 1
- 41 Control_ Execute Scene 2 [DPT_1.002 - 1bit] - 1-Execute Scene 2
- 42 Control_ Execute Scene 3 [DPT_1.002 - 1bit] - 1-Execute Scene 3
- 43 Control_ Execute Scene 4 [DPT_1.002 - 1bit] - 1-Execute Scene 4
- 44 Control_ Execute Scene 5 [DPT_1.002 - 1bit] - 1-Execute Scene 5

4.7.4 Scene "x" preset

This parameter lets define a preset for a scene (the following description is valid for all the scenes).

Figure 4.28 Parameter detail

- If set to **"No"** the preset for the scene "x" will be disabled.
- If set to **"Yes"** the preset will be enabled. When a scene is executed the values configured in the preset will be applied.

⚠ Important: If a scene's preset is enabled, will not be possible to modify (store) the scene from the KNX bus.

Figure 4.29 Parameter detail

➤ Scene "x" / Value for On-Off

This parameter lets choose the power of the indoor unit when the scene is executed. The following options are available: **"ON"**, **"OFF"** or **"(unchanged)"**.

➤ Scene "x" / Value for Mode

This parameter lets choose the mode of the indoor unit when the scene is executed. The following options are available: **"AUTO (if available)"**, **"HEAT (if available)"**, **"COOL"**, **"FAN"**, **"DRY"**, or **"(unchanged)"**.

➤ Scene "x" / Value for Fan Speed

This parameter lets choose the fan speed of the indoor unit when the scene is executed. The following options are available: **"FAN SPEED AUTO (if available)"**, **"FAN SPEED 1"**, **"FAN SPEED 2"**, **"FAN SPEED 3"**, **"FAN SPEED 4 (if available)"**, or **"(unchanged)"**.

➤ Scene "x" / Value for Vane U-D (if available)

This parameter lets choose the vane position of the indoor unit when the scene is executed. The following options are available: **"VANES U-D OFF"**, **"VANES U-D SWING"**, **"VANES U-D SWIRL (if available)"** or **"(unchanged)"**.

➤ Scene "x" / Value for Vane L-R (if available)

This parameter lets choose the vane position of the indoor unit when the scene is executed. The following options are available: **"VANES L-R OFF"**, **"VANES L-R SWING"**, **"VANES L-R SWIRL (if available)"** or **"(unchanged)"**.

➤ Scene "x" / Value for Setpoint Temp (°C)

This parameter lets choose the setpoint temperature of the indoor unit when the scene is executed. The following options are available: from **"16°C"** to **"30°C"** (both included) or **"(unchanged)"**.

➤ Scene "x" / Value for Remote Lock

This parameter lets choose the remote controller status of the indoor unit when the scene is executed. The following options are available: **"Locked (remote not allowed)"**, **"unlocked (remote allowed)"** or **"(unchanged)"**.

⚠ **Important:** If any preset value is configured as **"(unchanged)"**, the execution of this scene will not change current status of this feature in the AC unit.

⚠ **Important:** When a scene is executed, *Status_ Current Scene* object shows the number of this scene. Any change in previous items does *Status_ Current Scene* show

"No Scene". Only changes on items marked as **"(unchanged)"** will not disable current scene.

4.8 Switch-Off Timeouts Configuration dialog

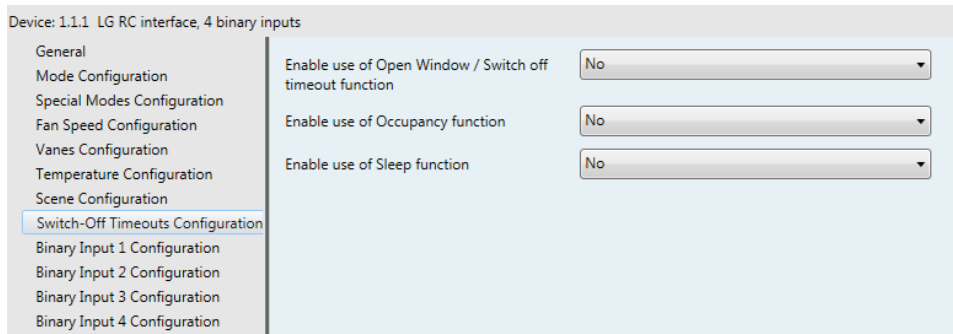

Figure 4.30 Default Switch-Off Timeouts Configuration dialog

All the parameters in this section are related with the timeout properties and communication objects.

4.8.1 Enable use of Open Window / Switch off timeout function

This parameter shows/hides the *Control_ Switch Off Timeout* communication object which lets Start/Stop a timeout to switch off the indoor unit.

- ↕ 25 Control_ Switch Off Timeout [DPT_1.010 - 1bit] - 0-Stop;1-Start
- ↕ 25 Control_ Window Contact Status [DPT_1.009 - 1bit] - 0-Open;1-Closed

- If set to **"No"** the object will not be shown.
- If set to **"Yes"** the *Control_ Switch Off Timeout* object and new parameters will appear. If a **"1"** value is sent to this object, and the indoor unit is already turned on, the switch-off timeout will begin. If a **"0"** value is sent to this object, the switch-off timeout will stop.

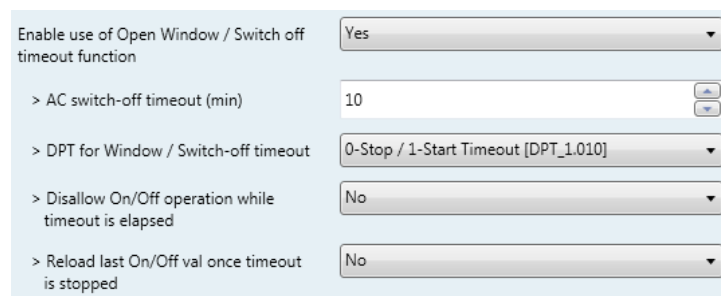

Figure 4.31 Parameter detail

➤ AC switch-off timeout (min)

This parameter lets select how much time (in minutes) to wait before switching off the indoor unit.

➤ DPT for Window / Switch-off timeout

This parameter lets choose between the datapoints **0-Open / 1-Closed Window [DPT_1.009]** and **0-Stop / 1-Start Timeout [DPT_1.010]** for the *Control_ Switch Off Timeout*.

➤ Disallow On/Off operation while window is Open

If set to **"No"**, On/Off commands while the window is open will be accepted.

- If a **"1"** value is sent to the *Control_ Switch Off Timeout* object the switch-off timeout period will begin again.
- If a **"0"** value is sent to the *Control_ Switch Off Timeout* object, no action will be performed.

If set to **"Yes"**, On/Off commands, while the window is open, will be saved (but not applied). These commands will be used in the next parameter if set to **"Yes"**.

➤ Reload last On/Off val once window is closed?

If set to **"No"**, once the switch-off timeout is stopped, any value will be reloaded.

If set to **"Yes"**, once the switch-off timeout is stopped, the last On/Off value sent will be reloaded.

- If a **"1"** value is sent to the *Control_ Switch Off Timeout* object after the timeout period, the indoor unit will **turn on**.
- If a **"0"** value is sent to the *Control_ Switch Off Timeout* after the timeout period, no action will be performed.

4.8.2 Enable use of Occupancy function

This parameter shows/hides the *Control_ Occupancy* communication object which lets apply different parameters to the indoor unit depending on the presence/no presence in the room.

➤ 26 Control_ Occupancy [DPT_1.018 - 1bit] - 0-Not Occupied;1-Occupied

- If set to **"No"** the object will not be shown.
- If set to **"Yes"** the *Control_ Occupancy* object and new parameters will appear. If a **"1"** value is sent to this object (no room occupancy), the timeout will begin. If a **"0"** value is sent to this object, the timeout will stop.

Enable use of Occupancy function	Yes
> Timeout to apply action (minutes)	20
> Action after timeout elapsed	Switch-Off AC
> Disallow On/Off operation while not Occupied	No
> Reload last On/Off value when Occupied	No

Figure 4.32 Parameter detail

➤ Timeout to apply action (minutes)

This parameter lets choose how much time to wait (in minutes) before executing the action specified in the next parameter (“Action after timeout elapsed”). This time is considered as a part of the occupancy.

➤ Action after timeout elapsed

When **Switch-Off** is selected, once the timeout has elapsed, the indoor unit will be turned off.

When **Apply Preset Delta** is selected, once the timeout has elapsed, a delta temperature will be applied in order to save energy (decreasing the setpoint when in Heat mode, or increasing the setpoint when in Cool mode). Also new parameters will appear.

Figure 4.33 Parameter detail

➤ Temp delta decrease (HEAT) or increase (COOL) (°C)

This parameter lets configure the delta temperature (increase or decrease) that will be applied when the timeout has elapsed.

⚠ Important: When there is occupancy again after the application of a delta, the same delta will be applied inversely. (i.e. In a room with AC in cool mode and 25°C setpoint temperature, a **+2°C** delta is applied after the occupancy timeout, setting the setpoint at 27°C because there is no occupancy in the room. If the setpoint is raised to 29°C during that period, when the room is occupied again, a **-2°C** delta will be applied and the final setpoint temperature will then be 27°C).

➤ Enable secondary timeout

If set to **“No”** nothing will be applied.

If set to **“Yes”**, a new timeout will be enabled and two new parameters will appear.

Figure 4.34 Parameter detail

➤ Timeout to apply action (minutes)

This parameter lets choose how much time to wait (in minutes) before executing the action specified in the next parameter ("Action after timeout elapsed").

➤ Action after timeout elapsed

When **Switch-Off** is selected, once the timeout has elapsed, the indoor unit will turn off.

When **Apply Preset Delta** is selected, once the timeout configured is extinguished, a delta temperature will be applied (decreasing the setpoint when in Heat mode, or increasing the setpoint when in Cool mode). Also new parameters will appear.

➤ Temp delta decrease (HEAT) or increase (COOL) (°C)

This parameter lets configure the delta temperature that will be applied when the timeout is extinguished.

⚠ Important: *When there is occupancy again after the application of a delta, the same delta will be applied inversely as explained above.*

➤ Disallow On/Off operation while not Occupied

If set to **"No"**, On/Off commands while the window is open will be accepted.

If set to **"yes"**, once **Switch-Off** action has been executed, On/Off commands will be saved (but not applied). These commands will be used in the next parameter if set to **"yes"**.

> Reload last On/Off value when Occupied	yes
> Disallow On/Off operation while not Occupied	yes

Figure 4.35 Parameter detail

Consider that the countdown time (transitional time between occupancy and non-occupancy) is considered as a part of the occupancy status as explained before.

➤ Reload last On/Off value when Occupied

If set to **"No"**, once the switch-off timeout has elapsed, any value will be reloaded.

If set to **"Yes"**, once the switch-off timeout has elapsed, the last On/Off value will be reloaded.

- If a **"1"** value is sent to the *Control_ Occupancy* object after the timeout period, the indoor unit will **turn on**.
- If a **"0"** value is sent to the *Control_ Occupancy* after the timeout period no action will be performed.

4.8.3 Enable use of SLEEP timeout

This parameter shows/hides the *Control_Sleep Timeout* communication object which lets start a timeout to automatically turn off the indoor unit.

➡ 27 Control_Sleep Timeout [DPT_1.010 - 1bit] - 0-Stop;1-Start

- If set to **"No"** the object will not be shown.
- If set to **"Yes"** the *Control_Sleep Timeout* object and a new parameter will appear. If a **"1"** value is sent to this object the switch-off timeout will begin. If a **"0"** value is sent to this object, the switch-off timeout will stop.

Enable use of SLEEP timeout	yes
> Sleep function switch-off timeout (minutes)	1

Figure 4.36 Parameter detail

➤ Timeout to apply action (minutes)

This parameter lets select how much time (in minutes) to wait before switching off the AC unit.

4.9 Binary Input "x" Configuration dialog

Device: 1.1.1 LG RC interface, 4 binary inputs	Enable use of Input 1	Yes
General	> Contact type	NO: Normally Open
Mode Configuration	> Debounce time	50 ms
Special Modes Configuration	> Disabling function	No
Fan Speed Configuration	> Function	Switching
Vanes Configuration	> Send telegram after bus recovery	No action
Temperature Configuration	> Value on raising edge (contact activated)	No action
Scene Configuration	> Value on falling edge (contact deactivated)	No action
Switch-Off Timeouts Configuration	> Cyclical sending	Never
Binary Input 1 Configuration		
Binary Input 2 Configuration		
Binary Input 3 Configuration		
Binary Input 4 Configuration		

Figure 4.37 Binary Input Configuration dialog

All the parameters in this section are related with the binary inputs properties and communication objects.

4.9.1 Enable use of Input "x"

This parameter enables the use of the Input "x" and shows/hides the *Status_Inx* communication object(s) which will act as configured in the "Function" parameter.

➡ 84 Status_In1 - Switching [DPT_1.001 - 1bit] - 0-Off;1-On
 ➡ 86 Status_In2 - Switching [DPT_1.001 - 1bit] - 0-Off;1-On

- ↕ 88 Status_In3 - Switching [DPT_1.001 - 1bit] - 0-Off;1-On
- ↕ 90 Status_In4 - Switching [DPT_1.001 - 1bit] - 0-Off;1-On

- If set to **"No"** the objects will not be shown.
- If set to **"Yes"** the *Status_Inx* object(s) and new parameters will appear.

4.9.2 Contact type

This parameter lets choose the behavior that will have the binary input depending on if the contact is normally open or normally closed.

- There are two possible options to configure the contact type: **"NO: Normally Open"** and **"NC: Normally Closed"**.

4.9.3 Debounce time

This parameter lets choose a debounce time (in milliseconds) that will be applied to the contact.

4.9.4 Disabling function

This parameter shows/hides the *Control_Disable Input x* communication object which will let disable/enable the input x.

- ↕ 45 Control_Disable Input 1 [DPT_1.003 - 1bit] - 0-Disable;1-Enable;
- ↕ 45 Control_Disable Input 1 [DPT_1.002 - 1bit] - 0-False;1-True

- If set to **"No"** any object will be shown.
- When **"DPT 1.003: 0-Disable; 1-Enable"** is selected, the input can be disabled using the value **"0"** and enabled using the value **"1"**.
- When **"DPT 1.002: 1-True (Disable); 0-False (Enable)"** is selected, the input can be disabled using the value **"1"** and enabled using the value **"0"**.

4.9.5 Function

This parameter lets choose the function that will have the binary input. There are 7 different functions available: Switching, Dimming, Shutter/Blind, Value, Execute Scene (internal), Occupancy (internal) and Window Contact (internal).

- When **"Switching"** is selected the communication object and new parameters for the Input "x" will appear as shown below.

- ↕ 84 Status_In1 - Switching [DPT_1.001 - 1bit] - 0-Off;1-On

> Function	Switching
> Send telegram after bus recovery	No action
> Value on raising edge (contact activated)	Toggle (On/Off)
> Value on falling edge (contact deactivated)	No action
> Cyclical sending	Never

Figure 4.38 Parameter detail

➤ Send telegram after bus recovery

This parameter lets select if the Binary Input "x" will send a telegram, or not, after a bus recovery and the type of telegram sent (if enabled).

- When **"No action"** is selected, no telegram will be sent after a bus recovery.
- When **"Current status"** is selected, the binary input will send a telegram with its current status after a bus recovery. Also a new parameter will appear (see below).
- When **"On"** is selected, the binary input will send a telegram with a **"1"** value after a bus recovery. Also a new parameter will appear (see below).
- When **"Off"** is selected, the binary input will send a telegram with a **"0"** value after a bus recovery. Also a new parameter will appear (see below).

> Sending delay after bus recovery (seconds)	10
--	----

Figure 4.39 Parameter detail

➤ Sending delay after a bus recovery (seconds)

This parameter lets configure a delay (in seconds) that will be applied after a bus recovery and, after which, a telegram will be sent.

➤ Value on rising edge

This parameter lets select the value that the Binary Input "x" will send on a rising edge (contact activated).

- When **"On"** is selected, the binary input will always send telegrams with a **"1"** value.
- When **"Off"** is selected, the binary input will always send telegrams with a **"0"** value.
- When **"Toggle (On/Off)"** is selected, the binary input will send a **"1"** value after a **"0"** value and viceversa.
- When **"No action"** is selected, the binary input will not perform any action.

➤ Value on falling edge

This parameter lets select the value that the Binary Input "x" will send on a falling edge (contact deactivated).

- When **"On"** is selected, the binary input will always send telegrams with a **"1"** value.
- When **"Off"** is selected, the binary input will always send telegrams with a **"0"** value.
- When **"Toggle (On/Off)"** is selected, the binary input will send a **"1"** value after a **"0"** value and viceversa.
- When **"No action"** is selected, the binary input will not perform any action.

➤ Cyclical sending

This parameter lets enable/disable cyclical sending when a determined condition is met.

- When **"When output value is On"** is selected, everytime a **"1"** value is sent, it will be sent cyclically. Also a new parameter will appear (see below).
- When **"When output value is Off"** is selected, everytime a **"0"** value is sent, it will be sent cyclically. Also a new parameter will appear (see below).
- When **"Always"** is selected, the binary input will send any value cyclically. Also a new parameter will appear (see below).
- When **"Never"** is selected, cyclical sending will be disabled.

➤ Period for cyclical sending (seconds)

This parameter lets configure a time (in seconds) for the cyclical sending.



Figure 4.40 Parameter detail

- When **"Dimming"** is selected the communication objects and new parameters for the Input "x" will appear as shown below.

- ↕ 86 Status_In2 - Dimming - On/Off [DPT_1.001 - 1bit] - 0-Off;1-On
- ↕ 87 Status_In2 - Dimming - Step(%) [DPT_3.007 - 4bit] - Dimming step

> Function	Dimming
> Send telegram after bus recovery	No action
> Mode for short (long) operation	Toggle: On/Off (increase/decrease)
> Increasing step	+ 100 %
> Decreasing step	- 100 %
> Short/long operation limit (x100ms)	10
> Cyclical sending period (x100ms) (0-No cyclical sending)	0

Figure 4.41 Parameter detail

➤ Send telegram after bus recovery

This parameter lets select if the Binary Input "x" will send a telegram, or not, after a bus recovery and the type of telegram sent (if enabled).

- When **"No action"** is selected, no telegram will be sent after a bus recovery.
- When **"On"** is selected, the binary input will send a telegram with a **"1"** value after a bus recovery. Also a new parameter will appear (see below).
- When **"Off"** is selected, the binary input will send a telegram with a **"0"** value after a bus recovery. Also a new parameter will appear (see below).

> Sending delay after bus recovery (seconds)	10
--	----

Figure 4.42 Parameter detail

➤ Sending delay after a bus recovery (seconds)

This parameter lets configure a delay (in seconds) that will be applied after a bus recovery and, after which, a telegram will be sent.

➤ Mode for short (long) operation

This parameter lets select the value that the Binary Input "x" will send on a rising edge (contact activated), for a short and a long operation.

- When **"On (increase)"** is selected, the binary input will always send telegrams with a **"1"** value for a short operation, and an **"increase step"** for a long operation.
- When **"Off (decrease)"** is selected, the binary input will always send telegrams with a **"0"** value for a short operation, and an **"decrease step"** for a long operation.
- When **"Toggle: On/Off (increase/decrease)"** is selected:
 - For the short operation the binary input will send a **"1"** value after a **"0"** value and viceversa.

- For the long operation the binary input will send an **"increase step"** after a **"decrease step"** and viceversa.
- ⚠ **Important:** Note that the first long operation in toggle depends on the last short operation, meaning that after a **"1"** value will be sent a **"decrease step"** and after a **"0"** value will be sent an **"increase step"**.
- ⚠ **Important:** The time period between a short and a long operation is defined in the parameter "Short/long operation limit (x100ms)".
- Increasing step
This parameter lets select the increasing step value (in %) that will be sent for a long operation.
- Decreasing step
This parameter lets select the decreasing step value (in %) that will be sent for a long operation.
- Short/long operation limit (x100ms)
This parameter lets introduce the time period difference for the short and the long operation.
- Cycl. send. period in long oper. (x100ms)
This parameter lets configure a time (in seconds) for the cyclical sending of a long operation.
- When **"Shutter/Blind"** is selected the communication objects and new parameters for the Input "x" will appear as shown below.

- 88 Status_In3 - Shut/Blind - Step [DPT_1.023 - 1bit] - 0-Step Up;1-Step Down
- 89 Status_In3 - Shut/Blind - Move [DPT_1.023 - 1bit] - 0-Move Up;1-Move Down

> Function	Shutter/Blind
> Send telegram after bus recovery	No action
> Operation	Toggle (Up/Down)
> Method	Step-Move-Step
> Short/long operation limit (x100ms)	10
> Vanes adjustment time (x100ms)	10

Figure 4.43 Parameter detail

- Send telegram after bus recovery

This parameter lets select if the Binary Input "x" will send a telegram, or not, after a bus recovery and the type of telegram sent (if enabled).

- When **"No action"** is selected, no telegram will be sent after a bus recovery.
- When **"Move Up"** is selected, the binary input will send a telegram with a **"0"** value after a bus recovery. Also a new parameter will appear (see below).
- When **"Move Down"** is selected, the binary input will send a telegram with a **"1"** value after a bus recovery. Also a new parameter will appear (see below).

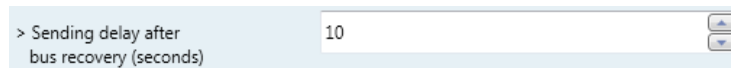

Figure 4.44 Parameter detail

➤ Sending delay after a bus recovery (seconds)

This parameter lets configure a delay (in seconds) that will be applied after a bus recovery and, after which, a telegram will be sent.

➤ Operation

This parameter lets select the value that the Binary Input "x" will send on a rising edge (contact activated).

- When **"Up"** is selected, the binary input will always send telegrams with a **"0"**.
- When **"Down"** is selected, the binary input will always send telegrams with a **"1"** value.
- When **"Toggle (Up/Down)"** is selected the binary input will send a **"0"** value after a **"1"** value and viceversa.

➤ Method

This parameter lets select the working method for the shutter/blind.

- When **"Step-Move-Step"** is selected: On a rising edge (contact activated) a step/stop telegram will be sent and will begin a time called **T1**. If a falling edge occurs (contact deactivated) during the **T1**, no action will be performed.

If the rising edge is maintained longer than **T1**, a move telegram will be sent and will start a time called **T2**. If a falling edge occurs during the **T2**, a step/stop telegram will be sent. If a falling edge occurs after **T2** no action will be performed.

- When **"Move-Step"** is selected: On a rising edge a move telegram will be sent and will begin the **T2** time. If a falling edge occurs during the **T2**, a step/stop telegram will be sent. If a falling edge occurs after **T2** no action will be performed.

⚠ **Important:** The **T1** time have to be defined in the "Short/long operation limit (x100ms)" parameter. Also the **T2** time have to be defined in the "Vanes adjustment time (x100ms)" parameter.

➤ Short/long operation limit (x100ms)

This parameter lets introduce the time period difference for the short and the long operation (T1 time).

➤ Vanes adjustment time (x100ms)

This parameter lets introduce the time period for the vanes adjustment/blind movement (T2 time).

- When **"Value"** is selected the communication objects and new parameters for the Input "x" will appear as shown below.

■ 91 Status_In4 - Value [DPT_5.010 - 1byte] - 1-byte unsigned value

> Function	Value
> Send telegram after bus recovery	Fixed value
> Sending delay after bus recovery (seconds)	10
> DPT to be sent	DPT 5.010 (1byte)
> Value on raising edge (when contact activated)	234

Figure 4.45 Parameter detail

➤ Send telegram after bus recovery

This parameter lets select if the Binary Input "x" will send a telegram, or not, after a bus recovery and the type of telegram sent (if enabled).

- When **"No action"** is selected, no telegram will be sent after a bus recovery.
- When **"Fixed value"** is selected, the binary input will send a telegram with the same value configured in the "Value on rising edge" parameter. Also a new parameter will appear (see below).

> Sending delay after bus recovery (seconds)	10
--	----

Figure 4.46 Parameter detail

➤ Sending delay after a bus recovery (seconds)

This parameter lets configure a delay (in seconds) that will be applied after a bus recovery and, after which, a telegram will be sent.

➤ DPT to be sent

This parameter lets select the DPT type for the value that will be defined in the next parameter. This value will be sent on a rising edge (contact activated).

Figure 4.47 Parameter detail

➤ Value on rising edge (when contact activated)

This parameter lets define a value for the DTP type configured in the "DPT to be sent" parameter. This value will be sent on a rising edge (contact activated).

- When "**Execute Scene (internal)**" is selected, the binary input "x" will activate the scene defined in the next parameter, on a rising edge (contact activated).

Figure 4.48 Parameter detail

➤ Scene when contact is activated

This parameter lets choose the scene that will be activated on a rising edge. This scene MUST be defined in the "Scene Configuration" dialog as a preset.

- When "**Occupancy (internal)**" is selected, the binary input "x" will have the same behavior as configured in the parameter "Enable use of Occupancy function" inside the "Switch-Off Timeouts Configuration" dialog.

Figure 4.49 Parameter detail

- When "**Window Contact (internal)**" is selected, the binary input "x" will have the same behavior as configured in the parameter "Enable use of Open Window / Switch off timeout function" inside the "Switch-Off Timeouts Configuration" dialog.

Figure 4.50 Parameter detail

5. Specifications

Envelope	Plastic, type ABS (UL 94 V-0). 2,5 mm thickness
Dimensions	71 X 71 X 27 mm
Weight	70g
Color	White, RAL 9010
Power supply	29V DC, 7mA Supplied through KNX bus.
LG AB Bus	Voltage: 13-15V Current: 10mA
LED indicators	1 x KNX programming.
Push buttons	1 x KNX programming.
Binary inputs	4 x Potential-free binary inputs. Signal cable length: 5m unshielded, may be extended up to 20m with twisted. Compliant with the following standards: IEC61000-4-2 : level 4 - 15kV (air discharge) - 8kV (contact discharge) MIL STD 883E-Method 3015-7 : class3B
Configuration	Configuration with ETS.
Operating Temperature	From -25°C to 60°C
Storage Temperature	From -40°C to 85°C
Isolation Voltage	2500V
RoHS conformity	Compliant with RoHS directive (2002/95/CE).
Certifications	CE conformity to EMC directive (2004/108/EC) and Low-voltage directive (2006/95/EC) EN 61000-6-1; EN 61000-6-3; EN 60950-1; EN 50491-3; EN 50090-2-2; EN 50428; EN 60669-1; EN 60669-2-1

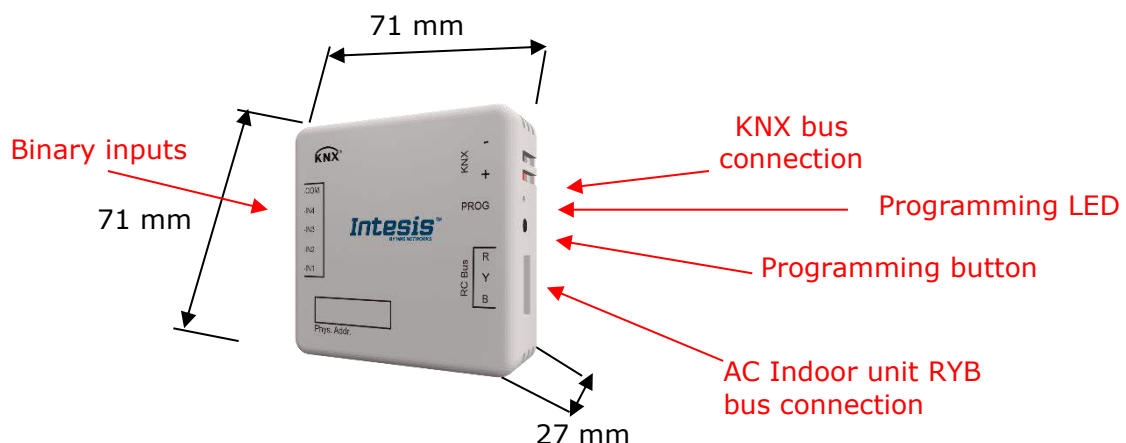

6. AC Unit Types compatibility

A list of LG indoor unit model references compatible with INKNXLGE001R000 and their available features can be found in:

https://www.intesis.com/docs/compatibilities/inxxxlge001r000_compatibility

7. Error Codes

Error in KNX	Remote Control Error	Error Description
1	1	Room air sensor fault
2	2	Indoor unit pipe in sensor fault
3	3	communication fault between wired remote controller and indoor unit
4	4	Drain pump fault
5	5	Communication fault between indoor unit and outdoor unit
6	6	Indoor unit pipe out sensor fault
7	7	Indoor unit mode runs on opposite to outdoor unit
8	8	N/A
9	9	EEPROM memory fault
10	10	BLDC motor signal fault or motor lock
11	11	HEX middle point sensor fault
12	12	heater terminal block sensor fault
13	13	N/A
14	14	N/A
15	15	N/A
16	16	N/A
17	17	Outlet air sensor fault
18	18	Return air sensor fault
19	19	No communication response from sub PCB to main PCB
20	20	No communication response from main PCB to sub PCB
21	21	IPM fault
22	22	AC input is over current (RMS)
23	23	DC link low or high voltage
24	24	High pressure or low pressure switch on
25	25	High/low input voltage
26	26	Compressor start failure
27	27	PSC/PFC fault
28	28	DC link high voltage
29	29	Over current at compressor input
32	32	Discharge temperature is high at inverter compressor
33	33	Discharge temperature is high at constant speed compressor
34	34	High pressure is too high
35	35	Low pressure is too low
36	36	Compression ratio is too low
39	39	Communication fault between PFC and inverter PCB
40	40	CT sensor fault
41	41	Discharge sensor at inverter compressor is fault
42	42	Low pressure sensor is fault
43	43	High pressure sensor is fault
44	44	Air sensor at outdoor unit is fault
45	45	HEX sensor at outdoor unit is fault
46	46	Compressor suction sensor is fault
47	47	Discharge sensor at constant speed compressor is fault
48	48	HEX outlet sensor at outdoor unit is fault
49	49	IPM temperature sensor is fault
50	50	Missing phase among 3 phase
51	51	Over combination ratio
52	52	No communication from inverter PCB detected at main PCB
53	53	Communication fault between indoor and outdoor unit
54	54	Reverse phase is detected
57	57	No communication from main PCB detected at inverter PCB
59	59	Wrong outdoor unit combination
60	60	Inverter EEPROM memory fault
61	61	Outdoor pipe temperature is too high

62	62	IPM temperature is too high
65	65	IPM temperature sensor is fault
67	67	Fan locked or fan start failure
69	69	CT sensor of constant speed compressor 1 is fault
70	70	CT sensor of constant speed compressor 2 is fault
71	71	PFC CT sensor fault
72	72	Fuction error of outdoor 4way valve.(reversing valve)
73	73	DC peak current is over
74	74	Unbalance at 3 phase
75	75	Fan CT sensor fault
76	76	Fan DC link voltage is high
77	77	Fan input voltage is high
78	78	Fan hall sensor fault
79	79	Fan motor start failure
86	86	Main PCB EEPROM is fault
87	87	Fan PCB EEPROM is fault
88	88	PFC PCB EEPROM is fault
90	90	Inlet temperature sensor of external PCB is fault
91	91	Outlet temperature sensor of external PCB is fault
104	104	No Communication from slave is detected
105	105	Communication fault between fan and inverter PCB
106	106	Fan PCB IOM fault
107	107	Fan DC link voltage is low
113	113	Liquid pipe sensor fault
114	114	Subcooling inlet pipe sensor fault
115	115	Subcooling outlet pipe sensor fault
116	116	Oil level sensor fault
145	145	No communication from external PCB is detected at main PCB
151	151	4 way valve failure
153	153	Upper HEX sensor fault
154	154	Bottom HEX sensor fault
173	173	Over / low current at constant speed compressor 1
174	174	Over / low current at constant speed compressor 2
182	182	Communication fault between main and sub micom in external PCB
187	187	Hydrokit water temperature sensor fault
190	190	Inverter PCB heak sink temperature is high
191	191	Inverter PCB heat sink temperature sensor fault
193	193	Fan PCB heak sink temperature is high
194	194	Fan PCB heat sink temperature sensor fault
200	200	Auto piping failure
201	201	Fault at liquid pipe sensor of HR unit
202	202	Fault at subcooling inlet pipe sensor of HR unit
203	203	Fault at subcooling outlet pipe sensor of HR unit
204	204	No communication from outdoor unit is detected at HR unit
205	205	HR unit addresses are duplicated
237	237	No response from outdoor unit modem at indoor unit modem
238	238	No response from outdoor unit at outdoor unit modem

Please, check your LG manual for a better understating of the error codes present in the associated Communication Object.

8. Appendix A – Communication Objects Table

TOPIC	OBJECT NUMBER	NAME	LENGTH	DATAPOINT TYPE		FLAGS				FUNCTION
				DPT_NAME	DPT_ID	R	W	T	U	
On/Off	0	Control_ On/Off	1 bit	DPT_Switch	1.001		W	T		0 - Off; 1-On
	1	Control_ Mode	1 byte	DPT_HVACContrMode	20.105		W	T		0 - Auto; 1 - Heat; 3 - Cool; 9 - Fan; 14 - Dry
Mode	2	Control_ Mode Cool/Heat	1 bit	DPT_Heat/Cool	1.100		W	T		0 - Cool; 1 - Heat;
	3	Control_ Mode Cool & On	1 byte	DPT_Scaling	5.001		W	T		0% - Off; 0.1%-100% - On + Cool
	4	Control_ Mode Heat & On	1 byte	DPT_Scaling	5.001		W	T		0% - Off; 0.1%-100% - On + Heat
	5	Control_ Mode Auto	1 bit	DPT_Bool	1.002		W	T		1 - Auto
	6	Control_ Mode Heat	1 bit	DPT_Bool	1.002		W	T		1 - Heat
	7	Control_ Mode Cool	1 bit	DPT_Bool	1.002		W	T		1 - Cool
	8	Control_ Mode Fan	1 bit	DPT_Bool	1.002		W	T		1 - Fan
	9	Control_ Mode Dry	1 bit	DPT_Bool	1.002		W	T		1 - Dry
	10	Control_ Mode +/-	1 bit	DPT_Step	1.007		W			0 - Decrease; 1 - Increase
		Control_ Mode +/-	1 bit	DPT_UpDown	1.008		W			0 - Up; 1 - Down
Fan Speed	11	Control_ Fan Speed / 3 Speeds	1 byte	DPT_Scaling	5.001		W	T		0%-49% - Speed 1; 50%-82% - Speed 2; 83%-100% - Speed 3;
		Control_ Fan Speed / 3 Speeds	1 byte	DPT_Enumerated	5.010		W	T		1 - Speed 1; 2 - Speed 2; 3 Speed 3;
		Control_ Fan Speed / 4 Speeds	1 byte	DPT_Scaling	5.001		W	T		0%-37% - Speed 1; 38%-62% - Speed 2; 63%-87% - Speed 3; 88%-100% - Speed 4;
		Control_ Fan Speed / 4 Speeds	1 byte	DPT_Enumerated	5.010		W	T		1- Speed 1; 2- Speed 2; 3- Speed 3; 4- Speed 4;
	12	Control_ Fan Speed Man/Auto	1 bit	DPT_Bool	1.002		W	T		0 – Manual; 1 – Auto
	13	Control_ Fan Speed 1	1 bit	DPT_Bool	1.002		W	T		1 – Set Fan Speed 1

Fan Speed	14	Control_ Fan Speed 2	1 bit	DPT_Bool	1.002		W	T	1 - Set Fan Speed 2
	15	Control_ Fan Speed 3	1 bit	DPT_Bool	1.002		W	T	1 - Set Fan Speed 3
	16	Control_ Fan Speed 4	1 bit	DPT_Bool	1.002		W	T	1 - Set Fan Speed 3
	17	Control_ Fan Speed +/-	1 bit	DPT_Step	1.007		W		0 - Decrease; 1 - Increase
		Control_ Fan Speed +/-	1 bit	DPT_UpDown	1.008		W		0 - Up; 1 - Down
Vanes Up-Down	18	Control_ Vanes U-D Swing	1 bit	DPT_Bool	1.002		W	T	0 - Off; 1 - Swing
	19	Control_ Vanes U-D Swirl	1 bit	DPT_Bool	1.002		W	T	0 - Off; 1 - Swirl
Vanes Left-Right	20	Control_ Vanes L-R Swing	1 bit	DPT_Bool	1.002		W	T	0 - Off; 1 - Swing
	21	Control_ Vanes L-R Swirl	1 bit	DPT_Bool	1.002		W	T	0 - Off; 1 - Swirl
Temperature	22	Control_ Setpoint Temperature	2 byte	DPT_Value_Temp	9.001		W	T	(°C)
	23	Control_ Setpoint Temp +/-	1 bit	DPT_Step	1.007		W		0 - Decrease; 1 - Increase
		Control_ Setpoint Temp +/-	1 bit	DPT_UpDown	1.008		W		0 - Up; 1 - Down
24	Control_ Ambient Temperature	2 byte	DPT_Value_Temp	9.001		W	T	(°C)	
Timeout	25	Control_ Window Contact Status	1 bit	DPT_OpenClose	1.009		W	T	0 - Open; 1 - Closed
		Control_ Switch Off Timeout	1 bit	DPT_Start	1.010		W	T	0 - Stop; 1 - Start
	26	Control_ Occupancy	1 bit	DPT_Occupancy	1.018		W	T	0 - Not Occupied; 1 - Occupied
27	Control_ Sleep Timeout	1 bit	DPT_Start	1.010		W	T	0 - Stop; 1 - Start	
Locking	28	Control_ Lock Remote Control	1 bit	DPT_Bool	1.002		W	T	0 - Unlock; 1 - Lock
	29	Control_ Lock Control Objects	1 bit	DPT_Bool	1.002		W	T	0 - Unlock; 1 - Lock
Special Modes	30	Control_ Power Mode	1 bit	DPT_Start	1.010		W	T	0 - Stop; 1 - Start
	31	Control_ Econo Mode	1 bit	DPT_Start	1.010		W	T	0 - Stop; 1 - Start
	32	Control_ Additional Heat	1 bit	DPT_Start	1.010		W	T	0 - Stop; 1 - Start

Scenes	33	Control_ Additional Cool	1 bit	DPT_Start	1.010		W	T	0 - Stop; 1 - Start
	34	Control_ Save/Exec Scene	1 byte	DPT_SceneControl	18.001		W	T	0 to 4 - Exec. Scene 1 to 5; 128 to 132 - Save Scene 1 to 5
	35	Control_ Store Scene1	1 bit	DPT_Bool	1.002		W		1 - Store Scene
	36	Control_ Store Scene2	1 bit	DPT_Bool	1.002		W		1 - Store Scene
	37	Control_ Store Scene3	1 bit	DPT_Bool	1.002		W		1 - Store Scene
	38	Control_ Store Scene4	1 bit	DPT_Bool	1.002		W		1 - Store Scene
	39	Control_ Store Scene5	1 bit	DPT_Bool	1.002		W		1 - Store Scene
	40	Control_ Execute Scene1	1 bit	DPT_Bool	1.002		W	T	1 - Execute Scene
	41	Control_ Execute Scene2	1 bit	DPT_Bool	1.002		W	T	1 - Execute Scene
	42	Control_ Execute Scene3	1 bit	DPT_Bool	1.002		W	T	1 - Execute Scene
	43	Control_ Execute Scene4	1 bit	DPT_Bool	1.002		W	T	1 - Execute Scene
	44	Control_ Execute Scene5	1 bit	DPT_Bool	1.002		W	T	1 - Execute Scene
Binary Input Disabling	45	Control_ Disable Input 1	1 bit	DPT_Bool	1.002		W	T	0 - False; 1 - True
		Control_ Disable Input 1	1 bit	DPT_Enable	1.003		W	T	0 - Disable; 1 - Enable
	46	Control_ Disable Input 2	1 bit	DPT_Bool	1.002		W	T	0 - False; 1 - True
		Control_ Disable Input 2	1 bit	DPT_Enable	1.003		W	T	0 - Disable; 1 - Enable
	47	Control_ Disable Input 3	1 bit	DPT_Bool	1.002		W	T	0 - False; 1 - True
		Control_ Disable Input 3	1 bit	DPT_Enable	1.003		W	T	0 - Disable; 1 - Enable
	48	Control_ Disable Input 4	1 bit	DPT_Bool	1.002		W	T	0 - False; 1 - True
		Control_ Disable Input 4	1 bit	DPT_Enable	1.003		W	T	0 - Disable; 1 - Enable

On/Off	50	Status_ On/Off	1 bit	DPT_Switch	1.001	R		T	0 - Off; 1-On
Mode	51	Status_ Mode	1 byte	DPT_HVACContrMode	20.105	R		T	0 - Auto; 1 - Heat; 3 - Cool; 9 - Fan; 14 - Dry
	52	Status_ Mode Cool/Heat	1 bit	DPT_Heat/Cool	1.100	R		T	0 - Cool; 1 - Heat
	53	Status_ Mode Auto	1 bit	DPT_Bool	1.002	R		T	1 - Auto
	54	Status_ Mode Heat	1 bit	DPT_Bool	1.002	R		T	1 - Heat
	55	Status_ Mode Cool	1 bit	DPT_Bool	1.002	R		T	1 - Cool
	56	Status_ Mode Fan	1 bit	DPT_Bool	1.002	R		T	1 - Fan
	57	Status_ Mode Dry	1 bit	DPT_Bool	1.002	R		T	1 - Dry
	58	Status_ Mode Text	14 byte	DPT_String_8859_1	16.001	R		T	ASCII String
Fan Speed	59	Status_ Fan Speed / 3 Speeds	1 byte	DPT_Scaling	5.001		W	T	33% - Speed 1; 67% - Speed 2; 100% - Speed 3;
		Status_ Fan Speed / 3 Speeds	1 byte	DPT_Enumerated	5.010		W	T	1 - Speed 1; 2 - Speed 2; 3 Speed 3;
		Status_ Fan Speed / 4 Speeds	1 byte	DPT_Scaling	5.001		W	T	25% - Speed 1; 50% - Speed 2; 75% - Speed 3; 100% - Speed 4;
		Status_ Fan Speed / 4 Speeds	1 byte	DPT_Enumerated	5.010		W	T	1- Speed 1; 2- Speed 2; 3- Speed 3; 4- Speed 4;
	60	Status_ Fan Speed Manual/Auto	1 bit	DPT_Bool	1.002	R		T	0 - Manual; 1 - Auto
	61	Status_ Fan Speed 1	1 bit	DPT_Bool	1.002	R		T	1 - Fan is in speed 1
	62	Status_ Fan Speed 2	1 bit	DPT_Bool	1.002	R		T	1 - Fan is in speed 2
	63	Status_ Fan Speed 3	1 bit	DPT_Bool	1.002	R		T	1 - Fan is in Speed 3
64	Status_ Fan Speed 4	1 bit	DPT_Bool	1.002	R		T	1 - Fan is in Speed 4	
65	Status_ Fan Speed Text	14 byte	DPT_String_8859_1	16.001	R		T	ASCII String	
Vanes Up-Down	66	Status_ Vanes U-D Swing	1 bit	DPT_Bool	1.002		W	T	0 - Off; 1 - Swing
	67	Status_ Vanes U-D Swirl	1 bit	DPT_Bool	1.002		W	T	0 - Off; 1 - Swirl

Vanes Left-Right	68	Status_ Vanes L-R Swing	1 bit	DPT_Bool	1.002		W	T	0 - Off; 1 - Swing
	69	Status_ Vanes L-R Swirl	1 bit	DPT_Bool	1.002		W	T	0 - Off; 1 - Swirl
Temperature	70	Status_ AC Setpoint Temp	2 byte	DPT_Value_Temp	9.001	R		T	(°C)
	71	Status_ AC Ambient Ref Temp	2 byte	DPT_Value_Temp	9.001	R		T	(°C)
Error	72	Status_ Error/Alarm	1 bit	DPT_Alarm	1.005	R		T	0 - No Alarm; 1 - Alarm
	73	Status_ Error Code	2 byte	Enumerated		R		T	0 - No Error; Any other see user's manual
	74	Status_ Error Text code	14 byte	DPT_String_8859_1	16.001	R		T	2 char LG Error; Empty - none
Locking	75	Status_ Lock Remote Control	1 bit	DPT_Bool	1.002	R		T	0 - Unlocked; 1 - Locked
	76	Status_ Lock Control Objects	1 bit	DPT_Bool	1.002	R		T	0 - Unlocked; 1 - Locked
Special Modes	77	Status_ Power Mode	1 bit	DPT_Switch	1.001	R		T	0 - Off; 1-On
	78	Status_ Econo Mode	1 bit	DPT_Switch	1.001	R		T	0 - Off; 1-On
	79	Status_ Additional Heat	1 bit	DPT_Switch	1.001	R		T	0 - Off; 1-On
	80	Status_ Additional Cool	1 bit	DPT_Switch	1.001	R		T	0 - Off; 1-On
Counter	81	Status_ Operation Hour Counter	2 byte	DPT_TimePeriodHrs	7.007	R		T	Number of operating hours
	82	Status_ Operation Sec Counter	4 byte	DPT_LongDeltaTimeSec	13.100	R		T	Number of operating seconds
Scene	83	Status_ Current Scene	1 byte	DPT_SceneNumber	17.001	R		T	0 to 4 - Scene 1 to 5; 63 - No Scene
Binary Inputs	84	Status_ Inx - Switching	1 bit	DPT_Switch	1.001	R		T	0 - Off; 1-On
	86	Status_ Inx – Dimming - On/Off	1 bit	DPT_Switch	1.001	R		T	0 - Off; 1 - On
	88								
	90	Status_ Inx – Shut/Blind - Step	1 bit	DPT_ShutterBlinds	1.023	R		T	0 – Step Up; 1 – Step Down
	85	Status_ Inx – Value	1 byte	DPT_Value_1_Ucount	5.010	R		T	1 byte unsigned value
	87	Status_ Inx – Value	2 byte	DPT_Value_2_Ucount	7.001	R		T	2 byte unsigned value
		Status_ Inx – Value	2 byte	DPT_Value_2_Count	8.001	R		T	2 byte signed value

	89	Status_ Inx – Value	2 byte	DPT_Value_Temp	9.001	R		T	Temperature (°C)
	91	Status_ Inx – Value	4 byte	DPT_Value_4_Ucount	12.001	R		T	4 byte unsigned value
		Status_ Inx – Dimming – Step(%)	1 bit	DPT_Control_Dimm.	3.007	R		T	Dimming step
		Status_ Inx - Shut/Blind -Move	1 bit	DPT_ShutterBlinds	1.023	R		T	0 – Move Up; 1 – Move Down