

DS90CF561/DS90CF562

LVDS 18-Bit Color Flat Panel Display (FPD) Link

General Description

The DS90CF561 transmitter converts 21 bits of CMOS/TTL data into three LVDS (Low Voltage Differential Signaling) data streams. A phase-locked transmit clock is transmitted in parallel with the data streams over a fourth LVDS link. Every cycle of the transmit clock 21 bits of input data are sampled and transmitted. The DS90CF562 receiver converts the LVDS data streams back into 21 bits of CMOS/TTL data. At a transmit clock frequency of 40 MHz, 18 bits of RGB data and 3 bits of LCD timing and control data (FPLINE, FPFRAME, DRDY) are transmitted at a rate of 280 Mbps per LVDS data channel. Using a 40 MHz clock, the data throughput is 105 Megabytes per second. These devices are offered with falling edge data strobes for convenient interface with a variety of graphics and LCD panel controllers.

This chipset is an ideal means to solve EMI and cable size problems associated with wide, high speed TTL interfaces.

Features

- Up to 105 Megabyte/sec bandwidth
- Narrow bus reduces cable size and cost
- 290 mV swing LVDS devices for low EMI
- Low power CMOS design
- Power down mode
- PLL requires no external components
- Low profile 48-lead TSSOP package
- Falling edge data strobe
- Compatible with TIA/EIA-644 LVDS standard

Block Diagrams

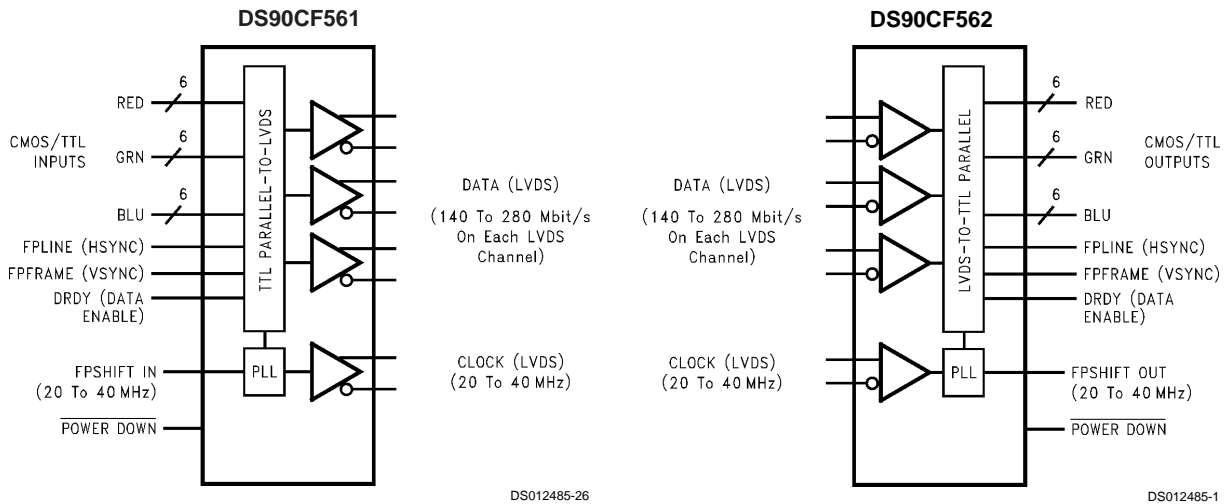

Order Number DS90CF561MTD
See NS Package Number MTD48

Order Number DS90CF562MTD
See NS Package Number MTD48

Application

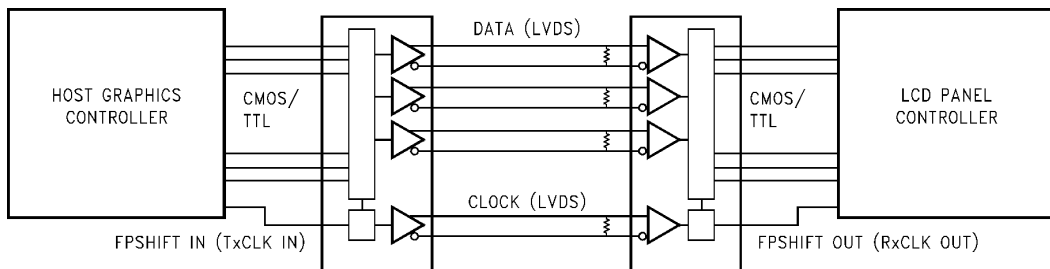

DS012485-2

Connection Diagrams

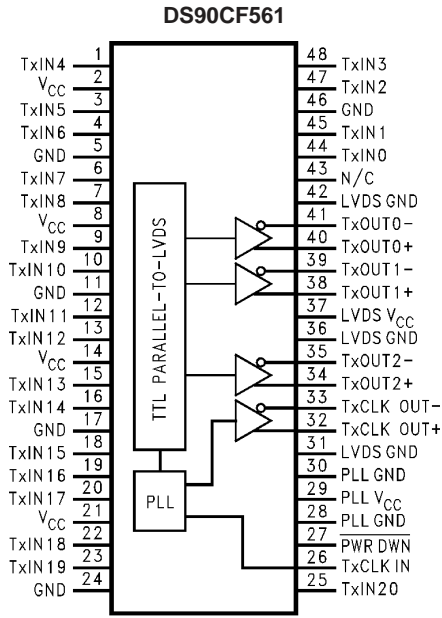

DS012485-3

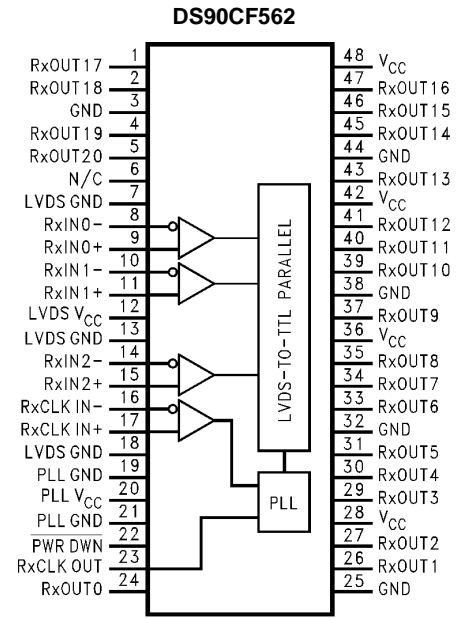

DS012485-4

Absolute Maximum Ratings (Note 1)

If Military/Aerospace specified devices are required, please contact the National Semiconductor Sales Office/Distributors for availability and specifications.

Supply Voltage (V_{CC})	-0.3V to +6V
CMOS/TTL Input Voltage	-0.3V to ($V_{CC} + 0.3V$)
CMOS/TTL Output Voltage	-0.3V to ($V_{CC} + 0.3V$)
LVDS Receiver Input Voltage	-0.3V to ($V_{CC} + 0.3V$)
LVDS Driver Output Voltage	-0.3V to ($V_{CC} + 0.3V$)
LVDS Output	
Short Circuit Duration	continuous
Junction Temperature	+150°C
Storage Temperature Range	-65°C to +150°C
Lead Temperature	
(Soldering, 4 sec.)	+260°C
Maximum Power Dissipation @ +25°C	
MTD48 (TSSOP) Package:	

DS90CF561	1.98W
DS90CF562	1.89W
Package Derating:	
DS90CF561	16 mW/°C above +25°C
DS90CF562	15 mW/°C above +25°C
This device does not meet 2000V ESD rating (Note 4).	

Recommended Operating Conditions

	Min	Nom	Max	Units
Supply Voltage (V_{CC})	4.5	5.0	5.5	V
Operating Free Air Temperature (T_A)	-10	+25	+70	°C
Receiver Input Range	0		2.4	V
Supply Noise Voltage (V_{CC})			100	mV _{P-P}

Electrical Characteristics

Over recommended operating supply and temperature ranges unless otherwise specified

Symbol	Parameter	Conditions	Min	Typ	Max	Units	
CMOS/TTL DC SPECIFICATIONS							
V_{IH}	High Level Input Voltage		2.0		V_{CC}	V	
V_{IL}	Low Level Input Voltage		GND		0.8	V	
V_{OH}	High Level Output Voltage	$I_{OH} = -0.4$ mA	3.8	4.9		V	
V_{OL}	Low Level Output Voltage	$I_{OL} = 2$ mA		0.1	0.3	V	
V_{CL}	Input Clamp Voltage	$I_{CL} = -18$ mA		-0.79	-1.5	V	
I_{IN}	Input Current	$V_{IN} = V_{CC}, GND, 2.5V$ or 0.4V		±5.1	±10	µA	
I_{OS}	Output Short Circuit Current	$V_{OUT} = 0V$			-120	mA	
LVDS DRIVER DC SPECIFICATIONS							
V_{OD}	Differential Output Voltage	$R_L = 100\Omega$	250	290	450	mV	
ΔV_{OD}	Change in V_{OD} between Complimentary Output States				35	mV	
V_{CM}	Common Mode Voltage		1.1	1.25	1.375	V	
ΔV_{CM}	Change in V_{CM} between Complimentary Output States				35	mV	
V_{OH}	High Level Output Voltage			1.3	1.6	V	
V_{OL}	Low Level Output Voltage		0.9	1.01		V	
I_{OS}	Output Short Circuit Current		$V_{OUT} = 0V, R_L = 100\Omega$		-2.9	-5	mA
I_{OZ}	Output TRI-STATE [®] ™ Current	Power Down = 0V, $V_{OUT} = 0V$ or V_{CC}		±1	±10	µA	
LVDS RECEIVER DC SPECIFICATIONS							
V_{TH}	Differential Input High Threshold	$V_{CM} = +1.2V$			+100	mV	
V_{TL}	Differential Input Low Threshold			-100		mV	
I_{IN}	Input Current	$V_{IN} = +2.4V$	$V_{CC} = 5.5V$		±10	µA	
		$V_{IN} = 0V$			±10	µA	
TRANSMITTER SUPPLY CURRENT							
I_{CCTW}	Transmitter Supply Current, Worst Case	$R_L = 100\Omega, C_L = 5$ pF, Worst Case Pattern (Figure 1, Figure 3)	$f = 32.5$ MHz		34	51	mA
			$f = 37.5$ MHz		36	53	mA
I_{CCTG}	Transmitter Supply Current, 16 Grayscale	$R_L = 100\Omega, C_L = 5$ pF, Grayscale Pattern (Figure 2, Figure 3)	$f = 32.5$ MHz		27	47	mA
			$f = 37.5$ MHz		28	48	mA

Electrical Characteristics (Continued)

Over recommended operating supply and temperature ranges unless otherwise specified

Symbol	Parameter	Conditions	Min	Typ	Max	Units	
TRANSMITTER SUPPLY CURRENT							
I_{CCTZ}	Transmitter Supply Current, Power Down	Power Down = Low		1	25	μA	
RECEIVER SUPPLY CURRENT							
I_{CCRW}	Receiver Supply Current, Worst Case	$C_L = 8 \text{ pF}$, Worst Case Pattern (Figure 1, Figure 4)	$f = 32.5 \text{ MHz}$		55	75	mA
			$f = 37.5 \text{ MHz}$		60	80	mA
I_{CCRG}	Receiver Supply Current, 16 Grayscale	$C_L = 8 \text{ pF}$, 16 Grayscale Pattern (Figure 2, Figure 4)	$f = 32.5 \text{ MHz}$		35	55	mA
			$f = 37.5 \text{ MHz}$		37	58	mA
I_{CCRZ}	Receiver Supply Current, Power Down	Power Down = Low		1	10	μA	

Note 1: "Absolute Maximum Ratings" are those values beyond which the safety of the device cannot be guaranteed. They are not meant to imply that the device should be operated at these limits. The tables of "Electrical Characteristics" specify conditions for device operation.

Note 2: Typical values are given for $V_{CC} = 5.0V$ and $T_A = +25^\circ C$.

Note 3: Current into device pins is defined as positive. Current out of device pins is defined as negative. Voltages are referenced to ground unless otherwise specified (except V_{OD} and ΔV_{OD}).

Note 4: ESD Rating:

HBM (1.5 k Ω , 100 pF)

PLL $V_{CC} \geq 1000V$

All other pins $\geq 2000V$

EIAJ (0 Ω , 200 pF) $\geq 150V$

Transmitter Switching Characteristics

Over recommended operating supply and temperature ranges unless otherwise specified

Symbol	Parameter	Min	Typ	Max	Units	
LLHT	LVDS Low-to-High Transition Time (Figure 3)		0.75	1.5	ns	
LHLT	LVDS High-to-Low Transition Time (Figure 3)		0.75	1.5	ns	
TCIT	TxCLK IN Transition Time (Figure 5)			8	ns	
TCCS	TxOUT Channel-to-Channel Skew (Note 5) (Figure 6)			350	ps	
TPPos0	Transmitter Output Pulse Position for Bit 0 (Figure 17)	$f = 20 \text{ MHz}$	-200	150	350	ps
TPPos1	Transmitter Output Pulse Position for Bit 1		6.3	7.2	7.5	ns
TPPos2	Transmitter Output Pulse Position for Bit 2		12.8	13.6	14.6	ns
TPPos3	Transmitter Output Pulse Position for Bit 3		20	20.8	21.5	ns
TPPos4	Transmitter Output Pulse Position for Bit 4		27.2	28	28.5	ns
TPPos5	Transmitter Output Pulse Position for Bit 5		34.5	35.2	35.6	ns
TPPos6	Transmitter Output Pulse Position for Bit 6		42.2	42.6	42.9	ns
TPPos0	Transmitter Output Pulse Position for Bit 0 (Figure 16)	$f = 40 \text{ MHz}$	-100	100	300	ps
TPPos1	Transmitter Output Pulse Position for Bit 1		2.9	3.3	3.9	ns
TPPos2	Transmitter Output Pulse Position for Bit 2		6.1	6.6	7.1	ns
TPPos3	Transmitter Output Pulse Position for Bit 3		9.7	10.2	10.7	ns
TPPos4	Transmitter Output Pulse Position for Bit 4		13	13.5	14.1	ns
TPPos5	Transmitter Output Pulse Position for Bit 5		17	17.4	17.8	ns
TPPos6	Transmitter Output Pulse Position for Bit 6		20.3	20.8	21.4	ns
TCIP	TxCLK IN Period (Figure 7)	25	T	50	ns	
TCIH	TxCLK IN High Time (Figure 7)	0.35T	0.5T	0.65T	ns	
TCIL	TxCLK IN Low Time (Figure 7)	0.35T	0.5T	0.65T	ns	
TSTC	TxIN Setup to TxCLK IN (Figure 7)	$f = 20 \text{ MHz}$	14			ns
		$f = 40 \text{ MHz}$	8			ns
THTC	TxIN Hold to TxCLK IN (Figure 7)	2.5	2		ns	

Transmitter Switching Characteristics (Continued)

Over recommended operating supply and temperature ranges unless otherwise specified

Symbol	Parameter	Min	Typ	Max	Units
TCCD	TxCLK IN to TxCLK OUT Delay @ 25°C, $V_{CC} = 5.0V$ (Figure 9)	5		9.7	ns
TPLLS	Transmitter Phase Lock Loop Set (Figure 11)			10	ms
TPDD	Transmitter Powerdown Delay (Figure 15)			100	ns

Note 5: This limit based on bench characterization.

Receiver Switching Characteristics

Over recommended operating supply and temperature ranges unless otherwise specified

Symbol	Parameter	Min	Typ	Max	Units
CLHT	CMOS/TTL Low-to-High Transition Time (Figure 4)		3.5	6.5	ns
CHLT	CMOS/TTL High-to-Low Transition Time (Figure 4)		2.7	6.5	ns
RCOP	RxCLK OUT Period (Figure 8)	25	T	50	ns
RSKM	Receiver Skew Margin (Note 6). $V_{CC} = 5V$, $T_A = 25^\circ C$ (Figure 18)	f = 20 MHz	1.1		ns
		f = 40 MHz	700		ps
RCOH	RxCLK OUT High Time (Figure 8)	f = 20 MHz	21.5		ns
		f = 40 MHz	10.5		ns
RCOL	RxCLK OUT Low Time (Figure 8)	f = 20 MHz	19		ns
		f = 40 MHz	6		ns
RSRC	RxOUT Setup to RxCLK OUT (Figure 8)	f = 20 MHz	14		ns
		f = 40 MHz	4.5		ns
RHRC	RxOUT Hold to RxCLK OUT (Figure 8)	f = 20 MHz	16		ns
		f = 40 MHz	6.5		ns
RCCD	RxCLK IN to RxCLK OUT Delay @ 25°C, $V_{CC} = 5.0V$ (Figure 10)	7.6		11.9	ns
RPLLS	Receiver Phase Lock Loop Set (Figure 12)			10	ms
RPDD	Receiver Powerdown Delay (Figure 16)			1	μs

Note 6: Receiver Skew Margin is defined as the valid data sampling region at the receiver inputs. This margin takes into account for transmitter output skew(TCCS) and the setup and hold time (internal data sampling window), allowing LVDS cable skew dependent on type/length and source clock(TxCLK IN) jitter.

$RSKM \geq \text{cable skew (type, length)} + \text{source clock jitter (cycle to cycle)}$

AC Timing Diagrams

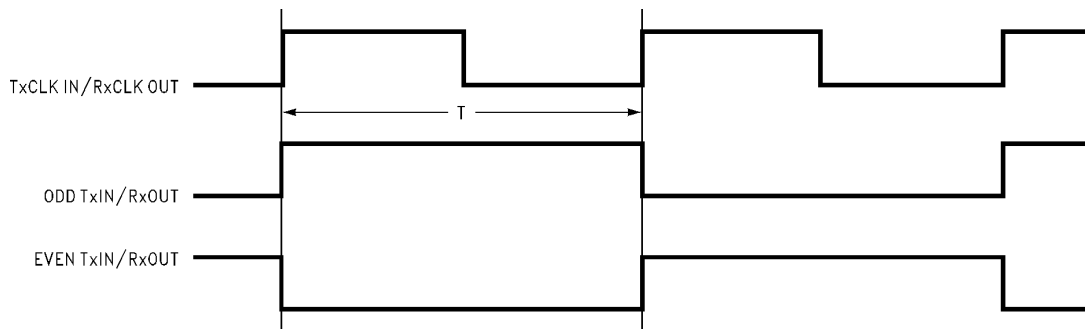

DS012485-5

FIGURE 1. "Worst Case" Test Pattern

AC Timing Diagrams (Continued)

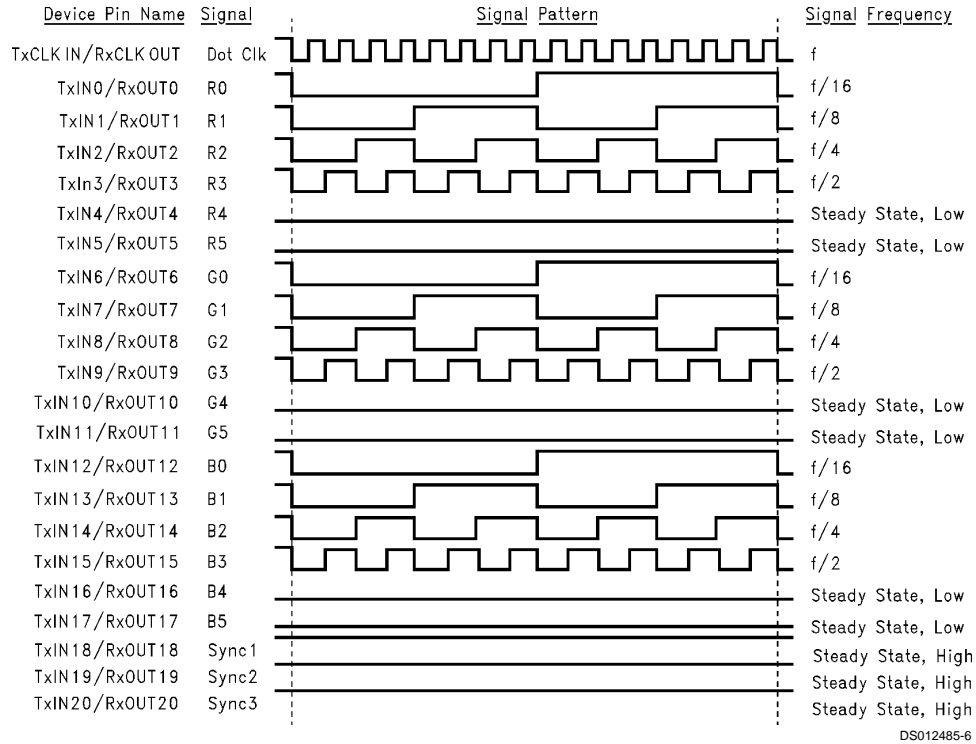

FIGURE 2. "16 Grayscale" Test Pattern (Notes 7, 8, 9, 10)

Note 7: The worst case test pattern produces a maximum toggling of device digital circuitry, LVDS I/O and TTL I/O.

Note 8: The 16 grayscale test pattern tests device power consumption for a "typical" LCD display pattern. The test pattern approximates signal switching needed to produce groups of 16 vertical stripes across the display.

Note 9: Figure 1 and Figure 2 show a falling edge data strobe (TxCLK IN/RxCLK OUT).

Note 10: Recommended pin to signal mapping. Customer may choose to define differently.

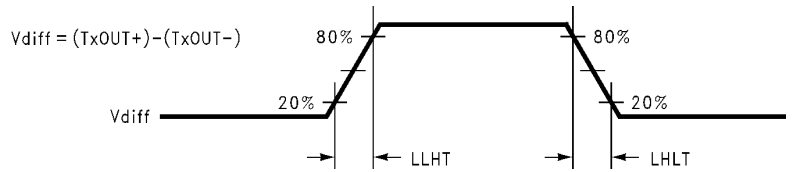
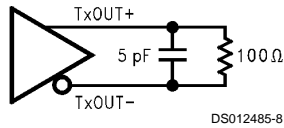

FIGURE 3. DS90CF561 (Transmitter) LVDS Output Load and Transition Timing

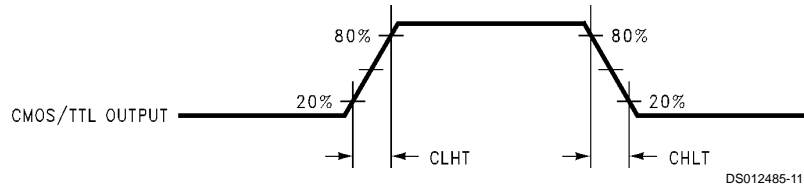
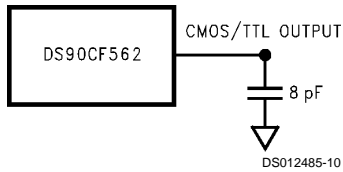

FIGURE 4. DS90CF562 (Receiver) CMOS/TTL Output Load and Transition Timing

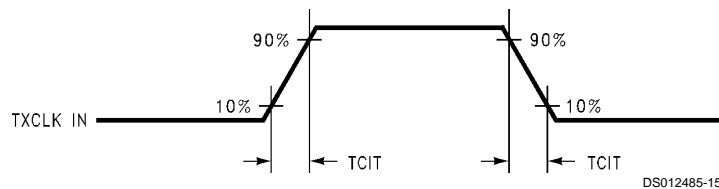
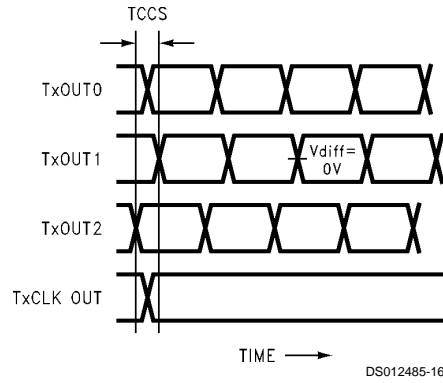

FIGURE 5. DS90CF561 (Transmitter) Input Clock Transition Time

AC Timing Diagrams (Continued)



Measurements at $V_{diff} = 0V$
 TCCS measured between earliest and latest initial LVDS edges.
 TxCLK OUT Differential High→Low Edge for DS90CF561
 TxCLK OUT Differential Low→High Edge for DS90CR561

FIGURE 6. DS90CF561 (Transmitter) Channel-to-Channel Skew and Pulse Width

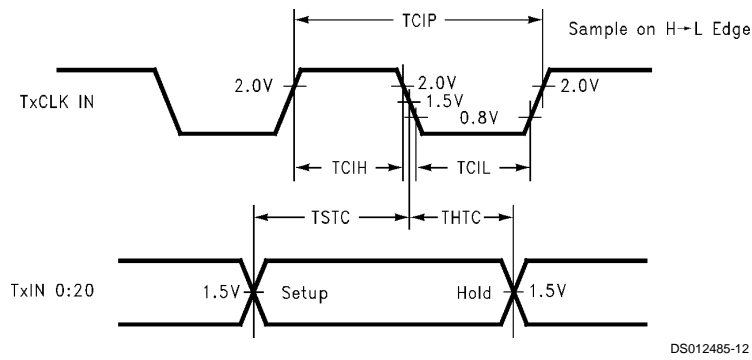

FIGURE 7. DS90CF561 (Transmitter) Setup/Hold and High/Low Times

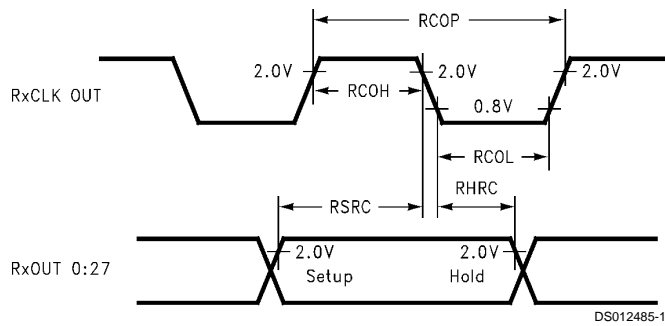

FIGURE 8. DS90CF562 (Receiver) Setup/Hold and High/Low Times

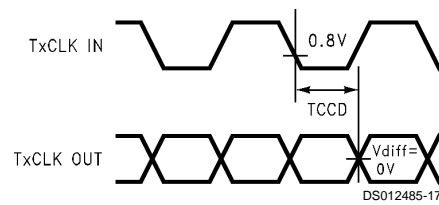

FIGURE 9. DS90CF561 (Transmitter) Clock In to Clock Out Delay

AC Timing Diagrams (Continued)

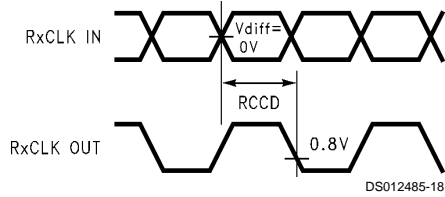

FIGURE 10. DS90CF562 (Receiver) Clock In to Clock Out Delay

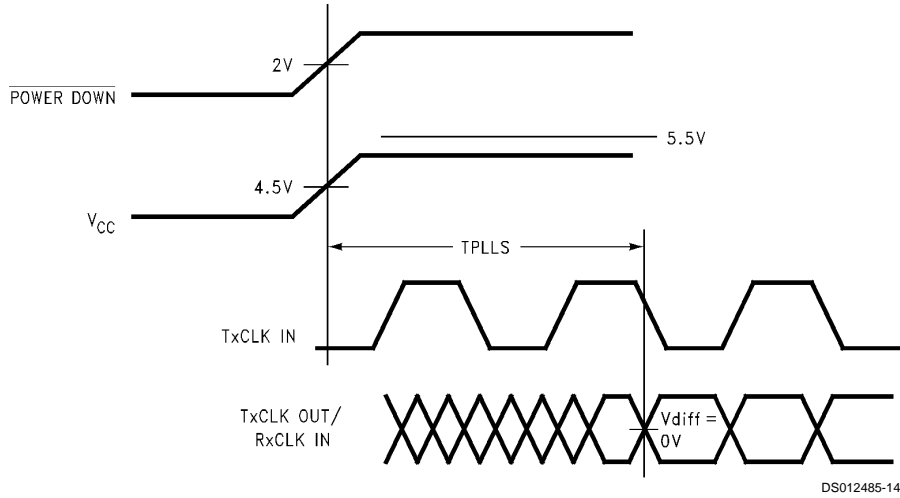

FIGURE 11. DS90CF561 (Transmitter) Phase Lock Loop Set Time

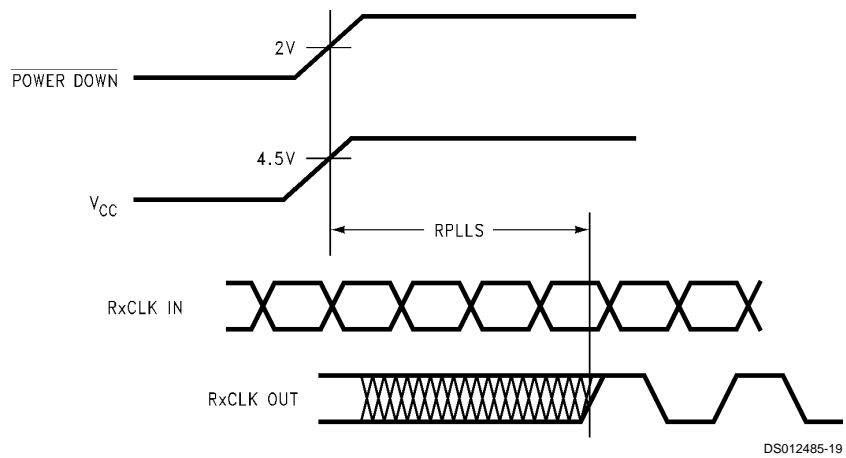

FIGURE 12. DS90CF562 (Receiver) Phase Lock Loop Set Time

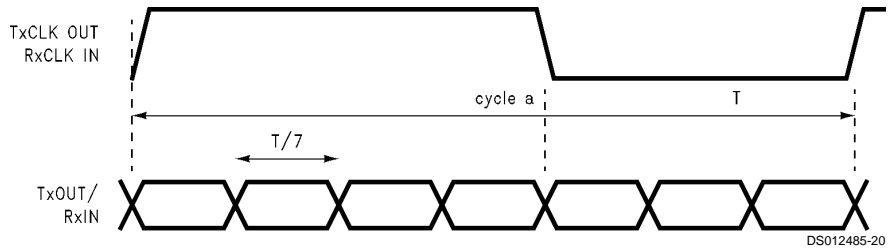

FIGURE 13. Seven Bits of LVDS in One Clock Cycle

AC Timing Diagrams (Continued)

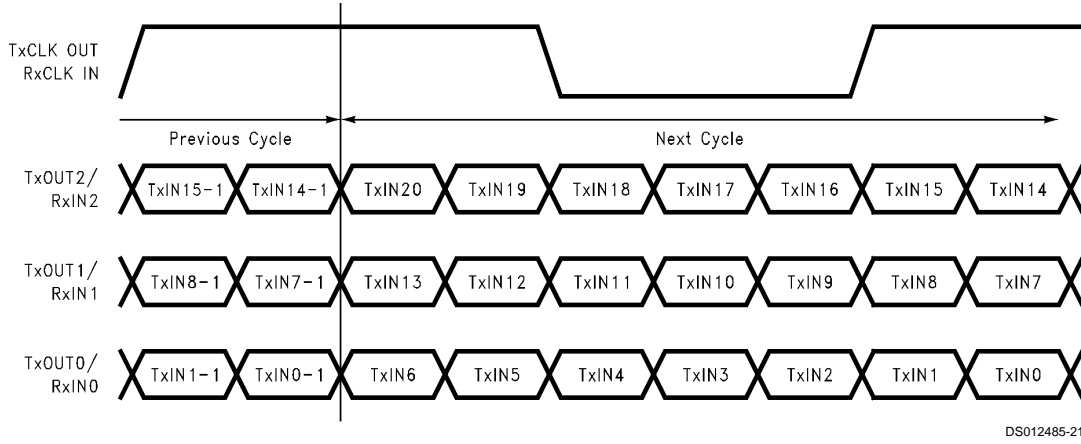

FIGURE 14. 21 Parallel TTL Data Inputs Mapped to LVDS Outputs (DS90CF561)

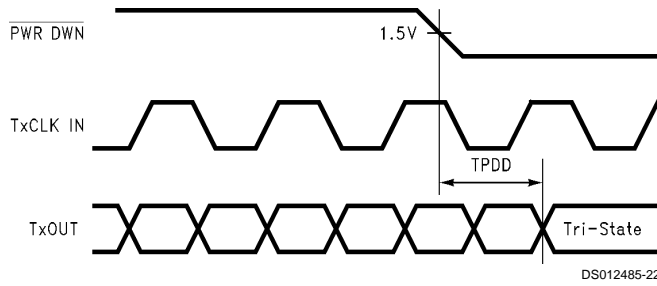

FIGURE 15. Transmitter Powerdown Delay

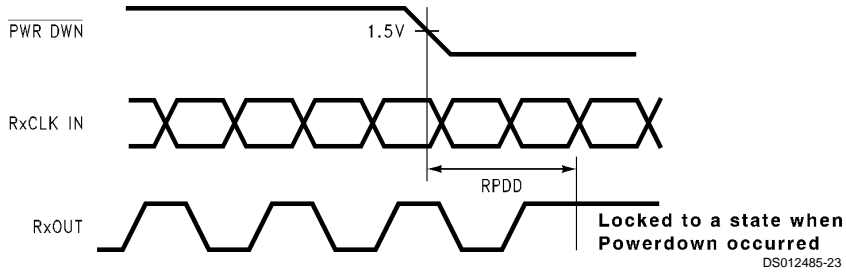
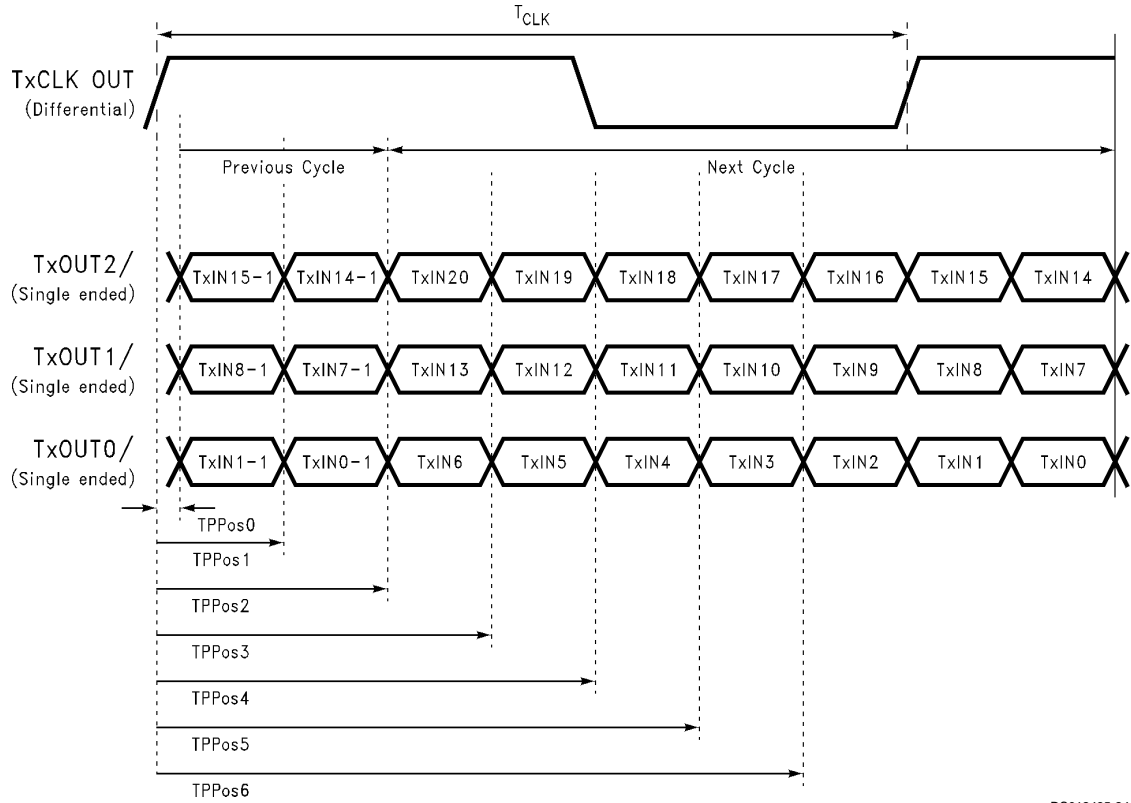

FIGURE 16. Receiver Powerdown Delay

AC Timing Diagrams (Continued)



DS012485-24

FIGURE 17. Transmitter LVDS Output Pulse Position Measurement

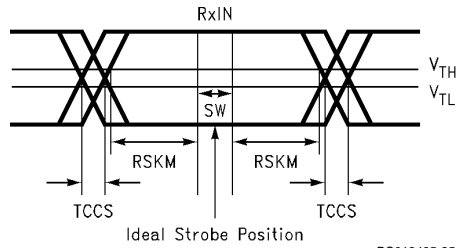

DS012485-25

- SW—Setup and Hold Time (Internal Data Sampling Window)
- TCCS—Transmitter Output Skew
- $RSKM \geq \text{Cable Skew (Type, Length)} + \text{Source Clock Jitter (Cycle to Cycle)}$
- Cable Skew—Typically 10 ps–40 ps per foot

FIGURE 18. Receiver LVDS Input Skew Margin

DS90CF561 Pin Description—FPD Link Transmitter

Pin Name	I/O	No.	Description
TxIN	I	21	TTL level input. This includes: 6 Red, 6 Green, 6 Blue, and 3 control lines (FPLINE, FPFRAME, DRDY). (Also referred to as HSYNC, VSYNC and DATA ENABLE.)
TxOUT+	O	3	Positive LVDS differential data output
TxOUT-	O	3	Negative LVDS differential data output
FPSHIFT IN	I	1	TTL level clock input. The falling edge acts as data strobe.
TxCLK OUT+	O	1	Positive LVDS differential clock output
TxCLK OUT-	O	1	Negative LVDS differential clock output
$\overline{\text{PWR DOWN}}$	I	1	TTL level input. Assertion (low input) TRI-STATES the outputs, ensuring low current at power down.
V _{CC}	I	4	Power supply pins for TTL inputs
GND	I	5	Ground pins for TTL inputs
PLL V _{CC}	I	1	Power supply pin for PLL
PLL GND	I	2	Ground pins for PLL
LVDS V _{CC}	I	1	Power supply pin for LVDS outputs
LVDS GND	I	3	Ground pins for LVDS outputs

DS90CF562 Pin Description—FPD Link Receiver

Pin Name	I/O	No.	Description
RxIN+	I	3	Positive LVDS differential data inputs
RxIN-	I	3	Negative LVDS differential data inputs
RxOUT	O	21	TTL level data outputs. This includes: 6 Red, 6 Green, 6 Blue, and 3 control lines (FPLINE, FPFRAME, DRDY). (Also referred to as HSYNC, VSYNC and DATA ENABLE.)
RxCLK IN+	I	1	Positive LVDS differential clock input
RxCLK IN-	I	1	Negative LVDS differential clock input
FPSHIFT OUT	O	1	TTL level clock output. The falling edge acts as data strobe.
$\overline{\text{PWR DOWN}}$	I	1	TTL level input. Assertion (low input) maintains the receiver outputs in the previous state
V _{CC}	I	4	Power supply pins for TTL outputs
GND	I	5	Ground pins for TTL outputs
PLL V _{CC}	I	1	Power supply for PLL
PLL GND	I	2	Ground pin for PLL
LVDS V _{CC}	I	1	Power supply pin for LVDS inputs
LVDS GND	I	3	Ground pins for LVDS inputs

Physical Dimensions inches (millimeters) unless otherwise noted

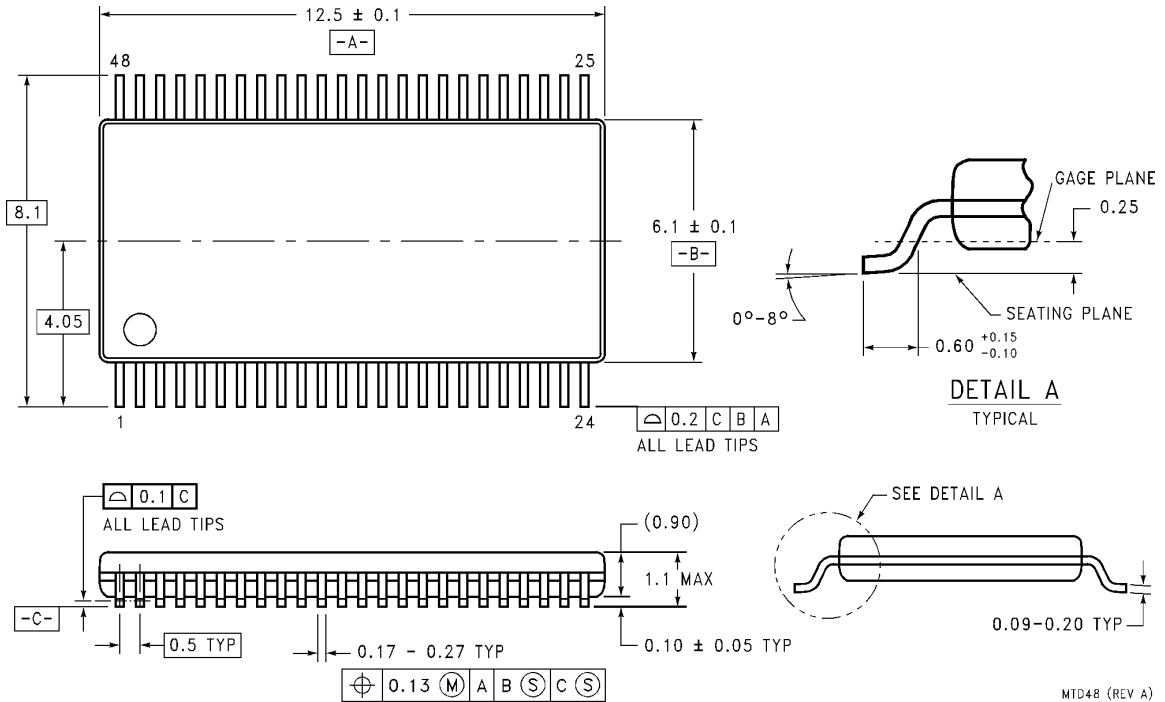

**48-Lead Molded Thin Shrink Small Outline Package, JEDEC
NS Package Number MTD48**

MTD48 (REV A)

LIFE SUPPORT POLICY

NATIONAL'S PRODUCTS ARE NOT AUTHORIZED FOR USE AS CRITICAL COMPONENTS IN LIFE SUPPORT DEVICES OR SYSTEMS WITHOUT THE EXPRESS WRITTEN APPROVAL OF THE PRESIDENT AND GENERAL COUNSEL OF NATIONAL SEMICONDUCTOR CORPORATION. As used herein:

1. Life support devices or systems are devices or systems which, (a) are intended for surgical implant into the body, or (b) support or sustain life, and whose failure to perform when properly used in accordance with instructions for use provided in the labeling, can be reasonably expected to result in a significant injury to the user.
2. A critical component is any component of a life support device or system whose failure to perform can be reasonably expected to cause the failure of the life support device or system, or to affect its safety or effectiveness.



National Semiconductor Corporation
Americas
Tel: 1-800-272-9959
Fax: 1-800-737-7018
Email: support@nsc.com
www.national.com

National Semiconductor Europe
Fax: +49 (0) 180-530 85 86
Email: europe.support@nsc.com
Deutsch Tel: +49 (0) 69 9508 6208
English Tel: +44 (0) 870 24 0 2171
Français Tel: +33 (0) 1 41 91 8790

National Semiconductor Asia Pacific Customer Response Group
Tel: 65-2544466
Fax: 65-2504466
Email: ap.support@nsc.com

National Semiconductor Japan Ltd.
Tel: 81-3-5639-7560
Fax: 81-3-5639-7507

See Imaging Products

Products > Analog - Flat Panel Display > Flat Panel Display Link > DS90CF561

DS90CF561 Product Folder

LVDS 18-Bit Color Flat Panel Display (FPD) Link

See Also: [DS90C363A](#) - 3V supply

[General Description](#)

[Features](#)

[Datasheet](#)

[Package & Models](#)

[Samples & Pricing](#)

[Application Notes](#)

Parametric Table

Supply Voltage	5 V
Pixel Clock	20 - 40 MHz

Parametric Table

Graphic Bits (bit)	6
Strobe Edge	Falling
Function	Transmitter, Receiver

Datasheet

Title	Size in Kbytes	Date	<input type="checkbox"/> View Online	<input type="checkbox"/> Download	<input type="checkbox"/> Receive via Email
DS90CF561 DS90CF562 LVDS 18-Bit Color Flat Panel Display (FPD) Link	242 Kbytes	16-Aug-00	View Online	Download	Receive via Email
DS90CF561 DS90CF562 LVDS 18-Bit Color Flat Panel Display (FPD) Link (JAPANESE)	475 Kbytes		View Online	Download	Receive via

If you have trouble printing or viewing PDF file(s), see [Printing Problems](#).

Package Availability, Models, Samples & Pricing

Part Number	Package			Status	Models		Samples & Electronic Orders	Budgetary Pricing		Std Pack Size	Package Marking
	Type	Pins	MSL		SPICE	IBIS		Qty	\$US each		
DS90CF561MTD	TSSOP	48	MSL	Full production	N/A	N/A	24 Hour Buy Now	1K+	\$4.0000	rail of 38	[logo]çUçZç2çT DS90CF561MTD çB
DS90CF561MTDX	TSSOP	48	MSL	Full production	N/A	N/A	Buy Now	1K+	\$4.0000	reel of 1000	[logo]çUçZç2çT DS90CF561MTD çB

DS90CF562 MDC	Die	Full production	N/A	N/A	Samples			tray of N/A	-
DS90CF561 MDC	Die	Full production	N/A	N/A	Samples			tray of N/A	-
DS90CF561 MWC	Wafer	Full production	N/A	N/A				wafer jar of N/A	-

General Description

The DS90CF561 transmitter converts 21 bits of CMOS/TTL data into three LVDS (Low Voltage Differential Signaling) data streams. A phase-locked transmit clock is transmitted in parallel with the data streams over a fourth LVDS link. Every cycle of the transmit clock 21 bits of input data are sampled and transmitted. The DS90CF562 receiver converts the LVDS data streams back into 21 bits of CMOS/TTL data. At a transmit clock frequency of 40 MHz, 18 bits of RGB data and 3 bits of LCD timing and control data (FPLINE, FPFRAME, DRDY) are transmitted at a rate of 280 Mbps per LVDS data channel. Using a 40 MHz clock, the data throughput is 105 Megabytes per second. These devices are offered with falling edge data strobes for convenient interface with a variety of graphics and LCD panel controllers.

This chipset is an ideal means to solve EMI and cable size problems associated with wide, high speed TTL interfaces.

Features

- Up to 105 Megabyte/sec bandwidth
- Narrow bus reduces cable size and cost
- 290 mV swing LVDS devices for low EMI
- Low power CMOS design
- Power down mode
- PLL requires no external components
- Low profile 48-lead TSSOP package
- Falling edge data strobe
- Compatible with TIA/EIA-644 LVDS standard

Application Notes

Title	Size in Kbytes	Date	View Online	Download	Receive via Email
AN-1056: Application Note 1056 STN Application Using FPD-Link	46 Kbytes	6-Oct-98	View Online	Download	Receive via Email
Application Note 1056 STN Application Using FPD-Link (JAPANESE)	54 Kbytes		View Online	Download	Receive via

If you have trouble printing or viewing PDF file(s), see [Printing Problems](#).

Search

[Design](#)

[Purchasing](#)

[Quality](#)

[Company](#)

[Home](#)

[About Languages](#) . [Website Guide](#) . [About "Cookies"](#) . National is [QS 9000 Certified](#) . [Privacy/Security Statement](#) .
[Contact Us](#) . [Site Terms & Conditions of Use](#) . Copyright 2002 © National Semiconductor Corporation . [My Preferences](#) .
[Feedback](#)

See Imaging Products

Products > Analog - Flat Panel Display > Flat Panel Display Link > DS90CF562

DS90CF562 Product Folder

LVDS 18-Bit Color Flat Panel Display (FPD) Link

See Also: [DS90CF364A](#) - 3V supply

[General Description](#)

[Features](#)

[Datasheet](#)

[Package & Models](#)

[Samples & Pricing](#)

Parametric Table

Supply Voltage	5 V
Pixel Clock	20 - 40 MHz

Parametric Table

Graphic Bits (bit)	6
Strobe Edge	Falling
Function	Receiver

Datasheet

Title	Size in Kbytes	Date	View Online	Download	Receive via Email
DS90CF561 DS90CF562 LVDS 18-Bit Color Flat Panel Display (FPD) Link	242 Kbytes	16-Aug-00	View Online	Download	Receive via Email
DS90CF561 DS90CF562 LVDS 18-Bit Color Flat Panel Display (FPD) Link (JAPANESE)	475 Kbytes		View Online	Download	Receive via

If you have trouble printing or viewing PDF file(s), see [Printing Problems](#).

Package Availability, Models, Samples & Pricing

Part Number	Package			Status	Models		Samples & Electronic Orders	Budgetary Pricing		Std Pack Size	Package Marking
	Type	Pins	MSL		SPICE	IBIS		Qty	\$US each		
DS90CF562MTD	TSSOP	48	MSL	Full production	N/A	N/A	24 Hour Buy Now	1K+	\$4.0000	rail of 38	[logo]çUçZç2çT DS90CF562MTD çB
DS90CF562MTDX	TSSOP	48	MSL	Full production	N/A	N/A	Buy Now	1K+	\$4.0000	reel of 1000	[logo]çUçZç2çT DS90CF562MTD çB

DS90CF562 MWC	Wafer	Full production	N/A	N/A				wafer jar of N/A	-
---------------	-----------------------	-----------------	-----	-----	--	--	--	------------------	---

General Description

The DS90CF561 transmitter converts 21 bits of CMOS/TTL data into three LVDS (Low Voltage Differential Signaling) data streams. A phase-locked transmit clock is transmitted in parallel with the data streams over a fourth LVDS link. Every cycle of the transmit clock 21 bits of input data are sampled and transmitted. The DS90CF562 receiver converts the LVDS data streams back into 21 bits of CMOS/TTL data. At a transmit clock frequency of 40 MHz, 18 bits of RGB data and 3 bits of LCD timing and control data (FPLINE, FPFRAME, DRDY) are transmitted at a rate of 280 Mbps per LVDS data channel. Using a 40 MHz clock, the data throughput is 105 Megabytes per second. These devices are offered with falling edge data strobes for convenient interface with a variety of graphics and LCD panel controllers.

This chipset is an ideal means to solve EMI and cable size problems associated with wide, high speed TTL interfaces.

Features

- Up to 105 Megabyte/sec bandwidth
- Narrow bus reduces cable size and cost
- 290 mV swing LVDS devices for low EMI
- Low power CMOS design
- Power down mode
- PLL requires no external components
- Low profile 48-lead TSSOP package
- Falling edge data strobe
- Compatible with TIA/EIA-644 LVDS standard

[Information as of 5-Aug-2002]

Search

[Design](#)

[Purchasing](#)

[Quality](#)

[Company](#)

[Home](#)

[About Languages](#) . [Website Guide](#) . [About "Cookies"](#) . National is [QS 9000 Certified](#) . [Privacy/Security Statement](#) . [Contact Us](#) . [Site Terms & Conditions of Use](#) . Copyright 2002 © National Semiconductor Corporation . [My Preferences](#) . [Feedback](#)