

# BC337/338

## Switching and Amplifier Applications

- Suitable for AF-Driver stages and low power output stages
- Complement to BC327/BC328



## NPN Epitaxial Silicon Transistor

### Absolute Maximum Ratings $T_a=25^\circ\text{C}$ unless otherwise noted

Symbol	Parameter	Value	Units
$V_{CES}$	Collector-Emitter Voltage		
	: BC337	50	V
	: BC338	30	V
$V_{CEO}$	Collector-Emitter Voltage		
	: BC337	45	V
	: BC338	25	V
$V_{EBO}$	Emitter-Base Voltage	5	V
$I_C$	Collector Current (DC)	800	mA
$P_C$	Collector Power Dissipation	625	mW
$T_J$	Junction Temperature	150	$^\circ\text{C}$
$T_{STG}$	Storage Temperature	-55 ~ 150	$^\circ\text{C}$

### Electrical Characteristics $T_a=25^\circ\text{C}$ unless otherwise noted

Symbol	Parameter	Test Condition	Min.	Typ.	Max.	Units
$BV_{CEO}$	Collector-Emitter Breakdown Voltage	$I_C=10\text{mA}, I_B=0$	45			V
			25			V
$BV_{CES}$	Collector-Emitter Breakdown Voltage	$I_C=0.1\text{mA}, V_{BE}=0$	50			V
			30			V
$BV_{EBO}$	Emitter-Base Breakdown Voltage	$I_E=0.1\text{mA}, I_C=0$	5			V
$I_{CES}$	Collector Cut-off Current	$V_{CE}=45\text{V}, I_B=0$ $V_{CE}=25\text{V}, I_B=0$		2	100	nA
				2	100	nA
$h_{FE1}$	DC Current Gain	$V_{CE}=1\text{V}, I_C=100\text{mA}$ $V_{CE}=1\text{V}, I_C=300\text{mA}$	100		630	
$h_{FE2}$			60			
$V_{CE}(\text{sat})$	Collector-Emitter Saturation Voltage	$I_C=500\text{mA}, I_B=50\text{mA}$			0.7	V
$V_{BE}(\text{on})$	Base Emitter On Voltage	$V_{CE}=1\text{V}, I_C=300\text{mA}$			1.2	V
$f_T$	Current Gain Bandwidth Product	$V_{CE}=5\text{V}, I_C=10\text{mA}, f=50\text{MHz}$		100		MHz
$C_{ob}$	Output Capacitance	$V_{CB}=10\text{V}, I_E=0, f=1\text{MHz}$		12		pF

### $h_{FE}$ Classification

Classification	16	25	40
$h_{FE1}$	100 ~ 250	160 ~ 400	250 ~ 630
$h_{FE2}$	60-	100-	170-

# Package Dimensions

## TO-92

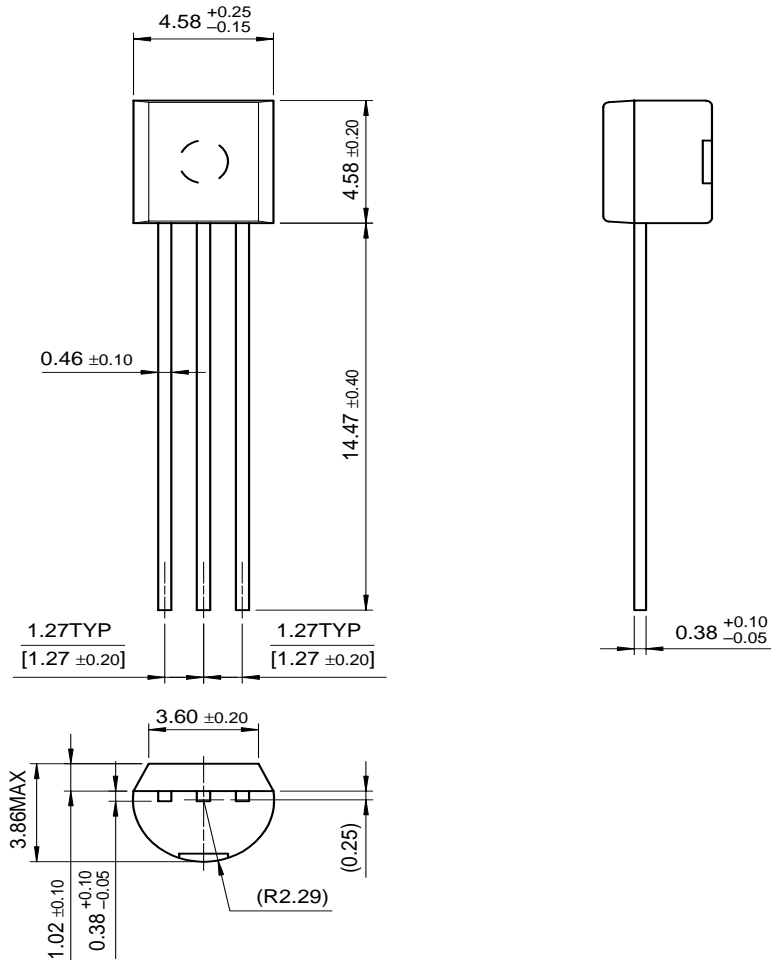

Dimensions in Millimeters

## TRADEMARKS

The following are registered and unregistered trademarks Fairchild Semiconductor owns or is authorized to use and is not intended to be an exhaustive list of all such trademarks.

ACE <sup>x</sup> <sup>TM</sup>	FACT <sup>TM</sup>	ImpliedDisconnect <sup>TM</sup>	PACMAN <sup>TM</sup>	SPM <sup>TM</sup>
ActiveArray <sup>TM</sup>	FACT Quiet series <sup>TM</sup>	ISOPLANAR <sup>TM</sup>	POP <sup>TM</sup>	Stealth <sup>TM</sup>
Bottomless <sup>TM</sup>	FAST <sup>®</sup>	LittleFET <sup>TM</sup>	Power247 <sup>TM</sup>	SuperSOT <sup>TM</sup> -3
CoolFET <sup>TM</sup>	FAST <sup>r</sup> <sup>TM</sup>	MicroFET <sup>TM</sup>	PowerTrench <sup>®</sup>	SuperSOT <sup>TM</sup> -6
CROSSVOL <sup>TM</sup>	FRFET <sup>TM</sup>	MicroPak <sup>TM</sup>	QFET <sup>TM</sup>	SuperSOT <sup>TM</sup> -8
DOME <sup>TM</sup>	GlobalOptoisolator <sup>TM</sup>	MICROWIRE <sup>TM</sup>	QS <sup>TM</sup>	SyncFET <sup>TM</sup>
EcoSPARK <sup>TM</sup>	GTO <sup>TM</sup>	MSX <sup>TM</sup>	QT Optoelectronics <sup>TM</sup>	TinyLogic <sup>TM</sup>
E <sup>2</sup> CMOS <sup>TM</sup>	HiSeC <sup>TM</sup>	MSXPro <sup>TM</sup>	Quiet Series <sup>TM</sup>	TruTranslation <sup>TM</sup>
EnSigna <sup>TM</sup>	I <sup>2</sup> C <sup>TM</sup>	OCX <sup>TM</sup>	RapidConfigure <sup>TM</sup>	UHC <sup>TM</sup>
Across the board. Around the world. <sup>TM</sup>		OCXPro <sup>TM</sup>	RapidConnect <sup>TM</sup>	UltraFET <sup>®</sup>
The Power Franchise <sup>TM</sup>		OPTOLOGIC <sup>®</sup>	SILENT SWITCHER <sup>®</sup>	VCX <sup>TM</sup>
Programmable Active Droop <sup>TM</sup>		OPTOPLANAR <sup>TM</sup>	SMART START <sup>TM</sup>	

## DISCLAIMER

FAIRCHILD SEMICONDUCTOR RESERVES THE RIGHT TO MAKE CHANGES WITHOUT FURTHER NOTICE TO ANY PRODUCTS HEREIN TO IMPROVE RELIABILITY, FUNCTION OR DESIGN. FAIRCHILD DOES NOT ASSUME ANY LIABILITY ARISING OUT OF THE APPLICATION OR USE OF ANY PRODUCT OR CIRCUIT DESCRIBED HEREIN; NEITHER DOES IT CONVEY ANY LICENSE UNDER ITS PATENT RIGHTS, NOR THE RIGHTS OF OTHERS.

## LIFE SUPPORT POLICY

FAIRCHILD'S PRODUCTS ARE NOT AUTHORIZED FOR USE AS CRITICAL COMPONENTS IN LIFE SUPPORT DEVICES OR SYSTEMS WITHOUT THE EXPRESS WRITTEN APPROVAL OF FAIRCHILD SEMICONDUCTOR CORPORATION.

As used herein:

1. Life support devices or systems are devices or systems which, (a) are intended for surgical implant into the body, or (b) support or sustain life, or (c) whose failure to perform when properly used in accordance with instructions for use provided in the labeling, can be reasonably expected to result in significant injury to the user.
2. A critical component is any component of a life support device or system whose failure to perform can be reasonably expected to cause the failure of the life support device or system, or to affect its safety or effectiveness.

## PRODUCT STATUS DEFINITIONS

### Definition of Terms

Datasheet Identification	Product Status	Definition
Advance Information	Formative or In Design	This datasheet contains the design specifications for product development. Specifications may change in any manner without notice.
Preliminary	First Production	This datasheet contains preliminary data, and supplementary data will be published at a later date. Fairchild Semiconductor reserves the right to make changes at any time without notice in order to improve design.
No Identification Needed	Full Production	This datasheet contains final specifications. Fairchild Semiconductor reserves the right to make changes at any time without notice in order to improve design.
Obsolete	Not In Production	This datasheet contains specifications on a product that has been discontinued by Fairchild semiconductor. The datasheet is printed for reference information only.

Home >> Find products >>

## BC338

NPN Epitaxial Silicon Transistor

### Contents

- [Features](#)
- [Applications](#)
- [Product status/pricing/packaging](#)
- [Order Samples](#)

• [Qualification Support](#)

**BUY**

### Datasheet

[Download this datasheet](#)



[e-mail this datasheet](#)



### This page

[Print version](#)

### Related Links

[Request samples](#)

[How to order products](#)

[Product Change Notices \(PCNs\)](#)

[Support](#)

[Sales support](#)

[Quality and reliability](#)

[Design center](#)

### Features

- Suitable for AF-Driver stages and low power output stages
- Complement to BC327/BC328

[back to top](#)

### Applications







#### Switching and Amplifier

[back to top](#)

[Product status/pricing/packaging](#)

**BUY**

Product	Product status	Pb-free Status	Pricing*	Package type	Leads	Packing method	Package Marking Convention**
BC338	Full Production	Full Production	\$0.079	<a href="#">TO-92</a>	3	BULK	Line 1: \$Y (Fairchild logo) &Z (Asm. Plant Code) &3 (3-Digit Date Code) Line 2: BC338
BC33816BU	Full Production	Full Production	\$0.0296	<a href="#">TO-92</a>	3	BULK	Line 1: BC338 Line 2: 16 Line 3: -&3
BC33816TA	Full Production		\$0.0296	<a href="#">TO-92</a>	3	AMMO	Line 1: BC338 Line 2: 16 Line 3: -&3

		 Full Production					
BC33825BU	Full Production	 Full Production	\$0.0296	<a href="#">TO-92</a>	3	BULK	<a href="#">Line 1: BC338</a> <a href="#">Line 2: 25</a> <a href="#">Line 3: -&amp;3</a>
BC33825TA	Full Production	 Full Production	\$0.0296	<a href="#">TO-92</a>	3	AMMO	<a href="#">Line 1: BC338</a> <a href="#">Line 2: 25</a> <a href="#">Line 3: -&amp;3</a>
BC33840BU	Full Production	 Full Production	\$0.0296	<a href="#">TO-92</a>	3	BULK	<a href="#">Line 1: BC338</a> <a href="#">Line 2: 40</a> <a href="#">Line 3: -&amp;3</a>
BC33840TA	Full Production	 Full Production	\$0.0296	<a href="#">TO-92</a>	3	AMMO	<a href="#">Line 1: BC338</a> <a href="#">Line 2: 40</a> <a href="#">Line 3: -&amp;3</a>
BC338BU	Full Production	 Full Production	\$0.0296	<a href="#">TO-92</a>	3	BULK	<a href="#">Line 1: BC338</a> <a href="#">Line 3: -&amp;3</a>
BC338TF	Full Production	 Full Production	\$0.0296	<a href="#">TO-92</a>	3	TAPE REEL	<a href="#">Line 1: BC338</a> <a href="#">Line 3: -&amp;3</a>
BC338TFR	Full Production	 Full Production	\$0.0296	<a href="#">TO-92</a>	3	TAPE REEL	<a href="#">Line 1: BC338</a> <a href="#">Line 3: -&amp;3</a>

\* Fairchild 1,000 piece Budgetary Pricing

\*\* A sample button will appear if the part is available through Fairchild's on-line samples program. If there is no sample button, please contact a [Fairchild distributor](#) to obtain samples



Indicates product with Pb-free second-level interconnect. For more information [click here](#).

Package marking information for product BC338 is available. [Click here for more information](#).

[back to top](#)

### Qualification Support

Click on a product for detailed qualification data

Product
<a href="#">BC338</a>
<a href="#">BC33816BU</a>
<a href="#">BC33816TA</a>
<a href="#">BC33825BU</a>
<a href="#">BC33825TA</a>
<a href="#">BC33840BU</a>
<a href="#">BC33840TA</a>
<a href="#">BC338BU</a>
<a href="#">BC338TF</a>
<a href="#">BC338TFR</a>

[back to top](#)

© 2007 Fairchild Semiconductor

