

MATERIAL NO. ON STRIP	MATERIAL NO. LOOSE PIECE	CABLE SIZE	DIM "A"	DIM "B"	USE WITH HOUSING ASSY
93302-0003	93302-0005	2.5mm ² / 14AWG	3.58	3.94	93301-0201
93302-0004	93302-0006	4.0-6.0mm ² / 12-10AWG	4.90	5.51	

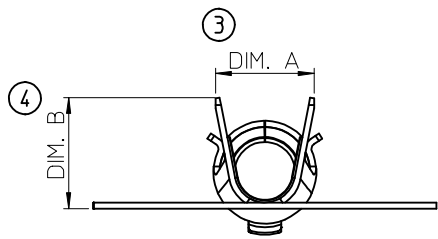

4.0-6.0mm²(12-10AWG)

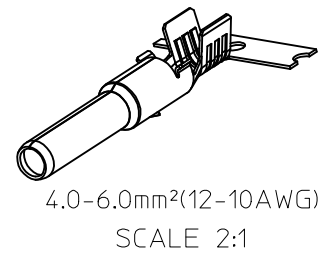
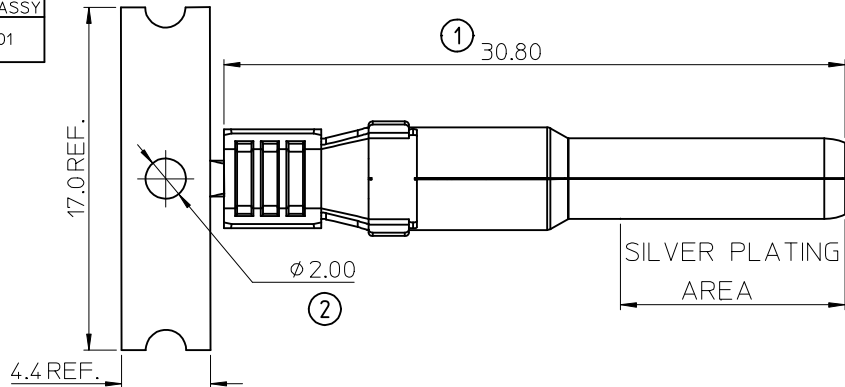
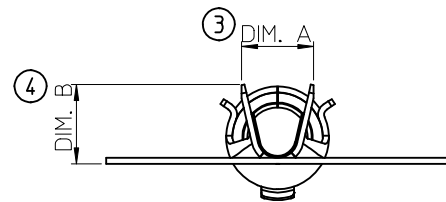
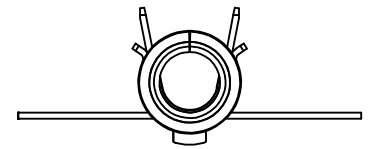
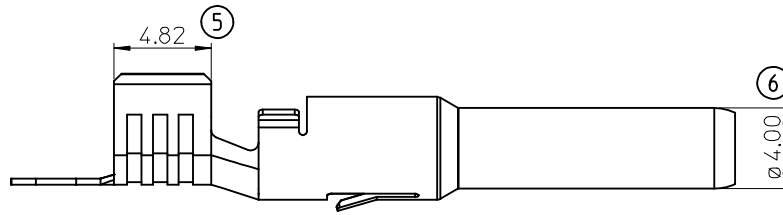

2.5mm²(14AWG)
SAME AS 4.0-6.0mm²(12-10AWG)
EXCEPT AS NOTED

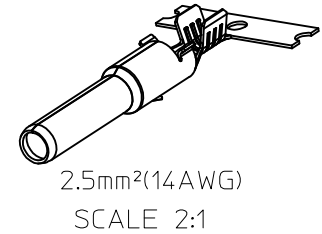
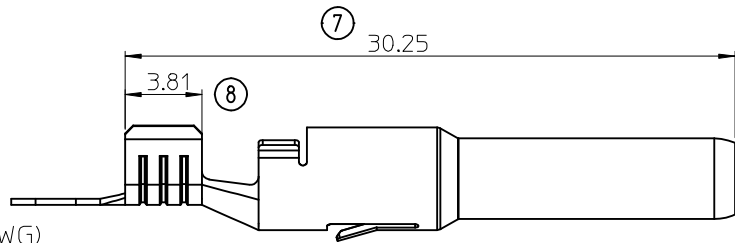

NOTES:

1. MATERIAL: COPPER ALLOY 0.30 THK.
2. FINISH: SELECTIVE SILVER OVER NICKEL.
3. TERMINAL FOR USE WITH 93301 SERIES PIN HOUSING ASSEMBLY. SEE CHART FOR APPLICABLE PART NUMBERS.
4. PRODUCT SPECIFICATION: PS-93301-001.
5. PACKAGING SPECIFICATION: PK-93302-001.
6. APPLICABLE TOOLING AND CRIMP SPECIFICATION: CONSULT FACTORY.
7. PARTS ARE ROHS COMPLIANT.

LAST INSPECTION No USED: 8

ORIGINAL RELEASE EC NO: E2011-0292 DRW:DBYRNES 2011/07/04 CHKD:SMCGREEVY 2011/08/16 APPR:EFOLAN 2011/08/26	QUALITY SYMBOLS ▽=0 ◻=0	GENERAL TOLERANCES (UNLESS SPECIFIED)		DIMENSION STYLE MM ONLY		SCALE 4:1	DESIGN UNITS METRIC	THIRD ANGLE PROJECTION	
		mm	INCH	DRAWN BY DBYRNES	DATE 2011/07/04	TITLE SOLARSPEC PIN CONTACT PV SOLAR PANEL MOUNT 2.5MM ² & 4-6MM ²			
		4 PLACES ± ---	± ---	CHECKED BY SMCGREEVY	DATE 2011/08/16	MOLEX INCORPORATED			
		3 PLACES ± ---	± ---	APPROVED BY EFOLAN	DATE 2011/08/26	MATERIAL NO. SD-93302-001			
2 PLACES ± 0.10	± ---	ANGULAR ± 2 °		SEE CHART		DOCUMENT NO.		SHEET NO. 1 OF 1	
1 PLACE ± 0.20	± ---	DRAFT WHERE APPLICABLE MUST REMAIN WITHIN DIMENSIONS		THIS DRAWING CONTAINS INFORMATION THAT IS PROPRIETARY TO MOLEX INCORPORATED AND SHOULD NOT BE USED WITHOUT WRITTEN PERMISSION					