

## DESCRIPTION

The MPQ4561 is a high-frequency, step-down, switching regulator with an integrated internal high-side high voltage power MOSFET. It provides up to a 1.5A output with current mode control for fast loop response and easy compensation.

The wide 3.8V-to-55V input range accommodates a variety of step-down applications, including those in automotive input environment. A 12 $\mu$ A shutdown mode supply current makes it suitable for battery-powered applications.

A scaled-down switching frequency in light-load conditions provides high power-conversion efficiency over a wide load range while reducing switching and gate driver losses.

The frequency foldback prevents inductor current runaway during startup and thermal shutdown provides reliable, fault tolerant operation.

By switching at 2MHz, the MPQ4561 is able to prevent EMI (Electromagnetic Interference) noise problems, such as those found in AM radio and ADSL applications.

The MPQ4561 is available in a 3mm x 3mm QFN10 package with an exposed pad.

## FEATURES

- Guaranteed Industrial/Automotive Temperature Range Limits
- Wide 3.8V to 55V Operating Input Range
- 300m $\Omega$  Internal Power MOSFET
- Up to 2MHz Programmable Switching Frequency
- 140 $\mu$ A Quiescent Current
- Stable with Ceramic Capacitor
- External Soft-Start
- Up to 95% Efficiency
- Output Adjustable from 0.8V to 52V
- Available in QFN10 (3mmx3mm) package
- AEC-Q100 Qualified

## APPLICATIONS

- High-Voltage Power Conversion
- Automotive Systems
- Industrial Power Systems
- Distributed Power Systems
- Battery Powered Systems

All MPS parts are lead-free and adhere to the RoHS directive. For MPS green status, please visit MPS website under Quality Assurance.

"MPS" and "The Future of Analog IC Technology" are Registered Trademarks of Monolithic Power Systems, Inc.

## TYPICAL APPLICATION

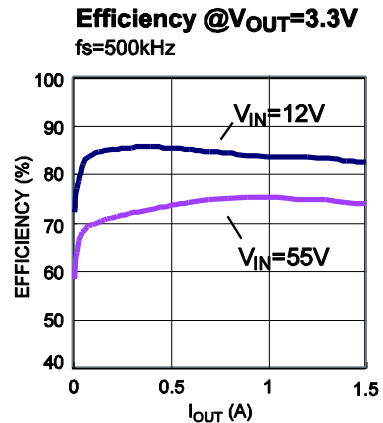
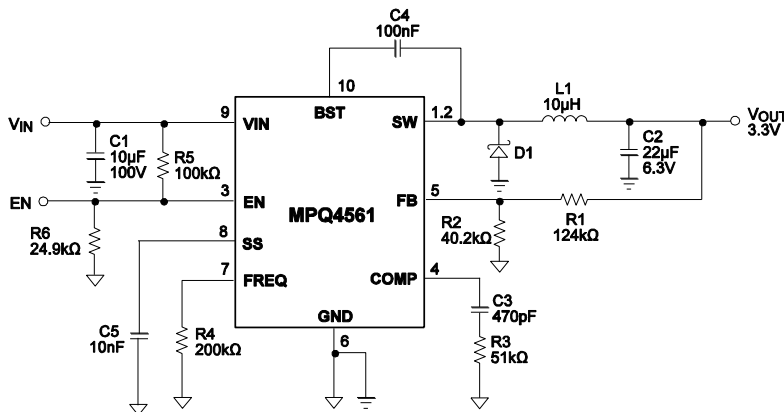

### ORDERING INFORMATION

Part Number	Package	Top Marking	Junction Temperature (T <sub>J</sub> )
MPQ4561DQ*	QFN10 (3x3mm)	9C	-40°C to +125°C
MPQ4561DQ-AEC1**		9C	

\* For Tape & Reel, add suffix -Z (e.g. MPQ4561DQ-AEC-Z)

For RoHS compliant packaging, add suffix -LF (e.g. MPQ4561DQ-AEC-LF-Z)

\*\* Available End Sept. 2011

### PACKAGE REFERENCE

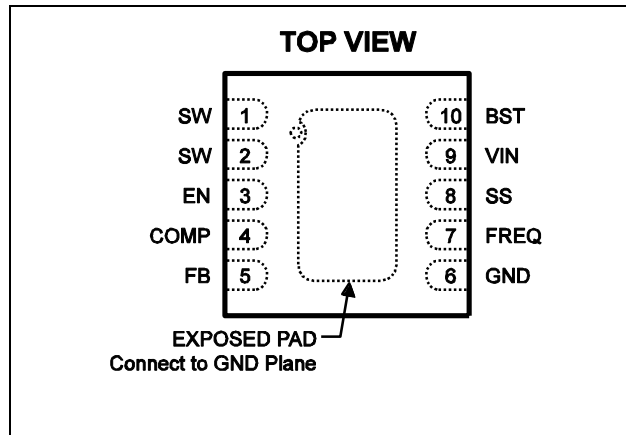

#### ABSOLUTE MAXIMUM RATINGS <sup>(1)</sup>

Supply Voltage (V <sub>IN</sub> )	-0.3V to +60V
Switch Voltage (V <sub>SW</sub> )	-0.5V to (V <sub>IN</sub> + 0.5V)
BST to SW	-0.3V to +5V
All Other Pins	-0.3V to +5V
Continuous Power Dissipation (T <sub>A</sub> = 25°C) <sup>(2)</sup>	2.5W
Junction Temperature	150°C
Lead Temperature	260°C
Storage Temperature	-65°C to +150°C

#### Recommended Operating Conditions <sup>(3)</sup>

Supply Voltage V <sub>IN</sub>	3.8V to 55V
Output Voltage V <sub>OUT</sub>	0.8V to 52V
Maximum Junction Temp. (T <sub>J</sub> )	+125°C

Thermal Resistance <sup>(4)</sup>	$\theta_{JA}$	$\theta_{JC}$
QFN10 (3x3mm)	50	12 ... °C/W

#### Notes:

- Exceeding these ratings may damage the device.
- The maximum allowable power dissipation is a function of the maximum junction temperature T<sub>J</sub>(MAX), the junction-to-ambient thermal resistance  $\theta_{JA}$ , and the ambient temperature T<sub>A</sub>. The maximum allowable continuous power dissipation at any ambient temperature is calculated by P<sub>D</sub>(MAX)=(T<sub>J</sub>(MAX)-T<sub>A</sub>)/ $\theta_{JA}$ . Exceeding the maximum allowable power dissipation will cause excessive die temperature, and the regulator will go into thermal shutdown. Internal thermal shutdown circuitry protects the device from permanent damage.
- The device is not guaranteed to function outside of its operating conditions.
- Measured on JESD51-7 4-layer board.

## ELECTRICAL CHARACTERISTICS

$V_{IN} = 12V$ ,  $V_{EN} = 2.5V$ ,  $V_{COMP} = 1.4V$ ,  $T_J = -40^{\circ}C$  to  $+125^{\circ}C$ , unless otherwise noted. Typical values are at  $T_J = 25^{\circ}C$ .

Parameter	Symbol	Condition	Min	Typ	Max	Units
Feedback Voltage	$V_{FB}$	$4.5V < V_{IN} < 55V$ $-40^{\circ}C$ to $+125^{\circ}C$	0.766	0.795	0.829	V
Upper Switch On Resistance <sup>(5)</sup>	$R_{DS(ON)}$	$V_{BST} - V_{SW} = 5V$ $-40^{\circ}C$ to $+125^{\circ}C$	200	300	475	m $\Omega$
Upper Switch Leakage		$V_{EN} = 0V$ , $V_{SW} = 0V$		1		$\mu A$
Current Limit		$-40^{\circ}C$ to $+125^{\circ}C$ (Duty Cycle $\leq 60\%$ )	1.7	2.5	3.3	A
COMP to Current Sense Transconductance	$G_{CS}$			4.5		A/V
Error Amp Voltage Gain				400		V/V
Error Amp Transconductance		$I_{COMP} = \pm 3\mu A$		120		$\mu A/V$
Error Amp Min Source current		$V_{FB} = 0.7V$		10		$\mu A$
Error Amp Min Sink current		$V_{FB} = 0.9V$		-10		$\mu A$
VIN UVLO Threshold		$-40^{\circ}C$ to $+125^{\circ}C$	2.4	3.0	3.6	V
VIN UVLO Hysteresis				0.35		V
Soft-Start Time <sup>(5)</sup>		$0V < V_{FB} < 0.8V$ , $C_{SS} = 10nF$		1.6		ms
Oscillator Frequency		$R_{FREQ} = 95k\Omega$ $-40^{\circ}C$ to $+125^{\circ}C$	0.7	1	1.3	MHz
Shutdown Supply Current		$V_{EN} < 0.3V$		12	20	$\mu A$
Quiescent Supply Current		No load, $V_{FB} = 0.9V$		140		$\mu A$
Thermal Shutdown		Hysteresis = $20^{\circ}C$		150		$^{\circ}C$
Minimum Off Time				100		ns
Minimum On Time <sup>(5)</sup>		$-40^{\circ}C$ to $+125^{\circ}C$		100	130	ns
EN Up Threshold		$-40^{\circ}C$ to $+125^{\circ}C$	1.3	1.55	1.8	V
EN Threshold Hysteresis				320		mV

**Note:**

5) Not production tested. Specified by design and bench characterization.

## PIN FUNCTIONS

QFN Pin #	Name	Description
1, 2	SW	Switch Node. Output of the high-side switch. Requires a low $V_F$ Schottky rectifier to ground. Place the rectifier close to the SW pins to reduce switching spikes..
3	EN	Enable Input. Pull this pin below the specified threshold to shut the chip down. Pull it above the specified threshold or leaving it floating to enable the chip.
4	COMP	Compensation. GM error amplifier output. Apply control-loop frequency compensation to this pin.
5	FB	Feedback. This is the input to the error amplifier. Connect an external resistive divider connected between the output and GND. Compare to the internal +0.8V reference to set the regulation voltage.
6	GND, Exposed Pad	Ground. Connect as close as possible to the output capacitor and avoid high-current switching paths. Connect the exposed pad to GND plane for optimal thermal performance.
7	FREQ	Switching Frequency Program Input. Connect a resistor from this pin to ground to set the switching frequency.
8	SS	Soft start programming mode. Connect a capacitor between SS and GND to set the soft start time.
9	VIN	Input Supply. Supplies power to all the internal control circuitry, both BS regulators, and the high-side switch. Place a decoupling capacitor to ground close to this pin to minimize switching spikes.
10	BST	Bootstrap. This is the positive power supply for the internal floating high-side MOSFET driver. Connect a bypass capacitor between this pin and the SW pin.

## TYPICAL CHARACTERISTICS

**On Resistance vs. Junction Temperature**

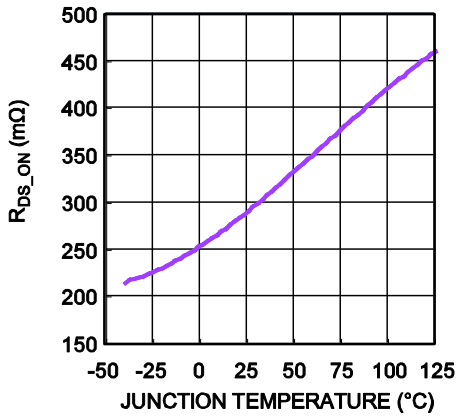

**Current Limit vs. Duty Cycle**

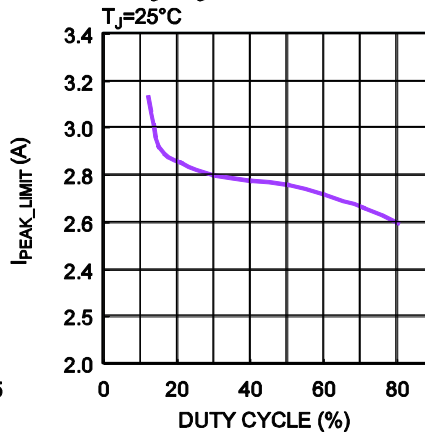

**Current Limit vs. Junction Temperature**

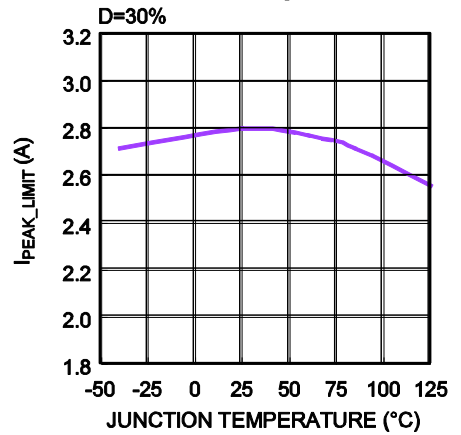

**Voltage Reference vs. Junction Temperature**

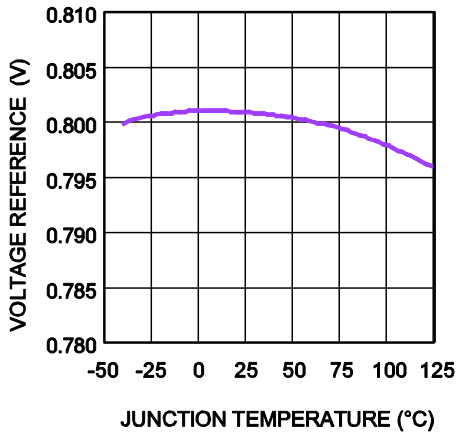

**$V_{IN}$  Start-up vs. Junction Temperature**

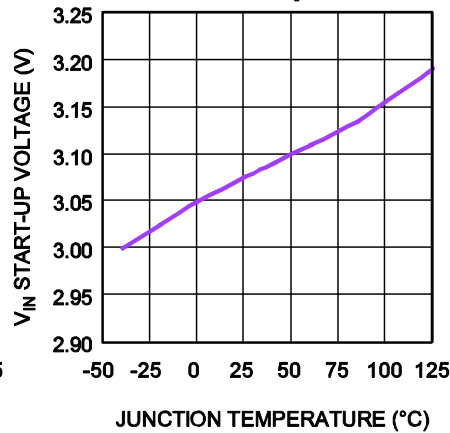

**$V_{IN}$  Shut-down vs. Junction Temperature**

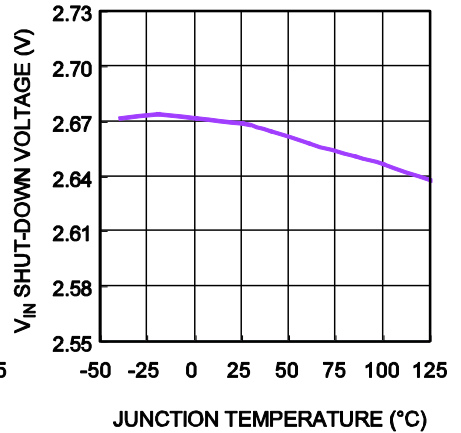

**Venable-high vs. Junction Temperature**

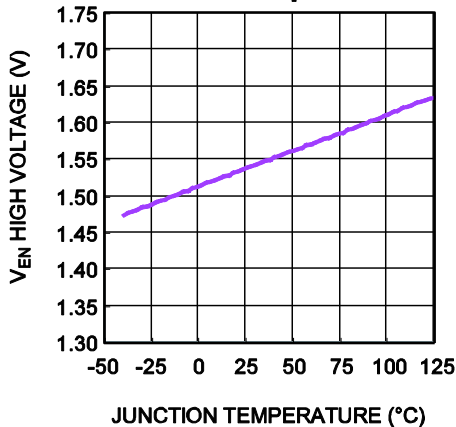

**Venable-low vs. Junction Temperature**

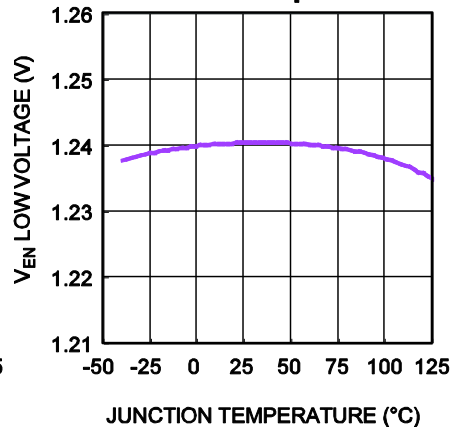

**Frequency vs.  $F_{REQ}$  Resistor**

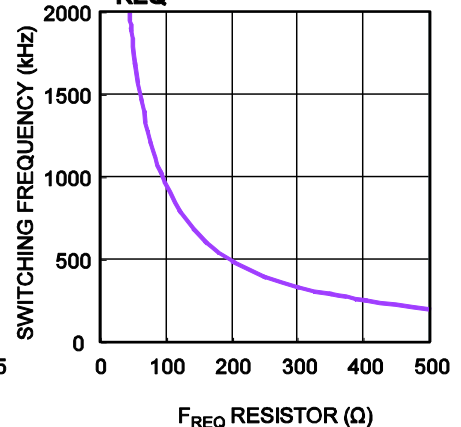

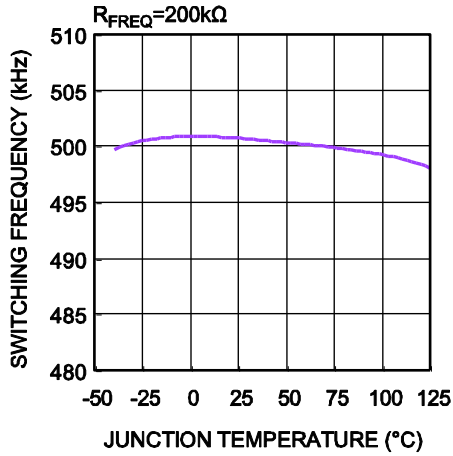
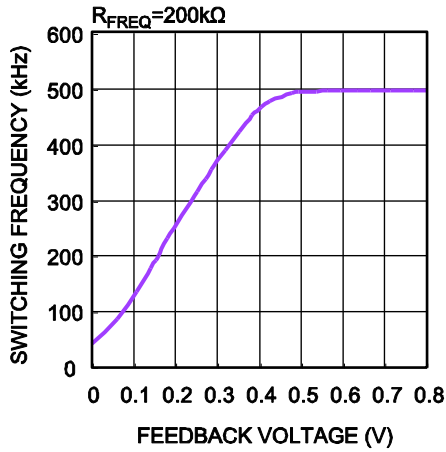
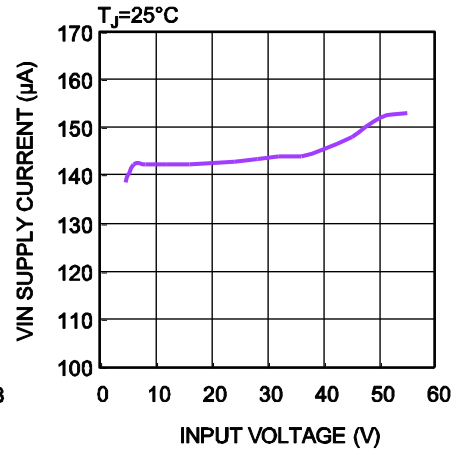
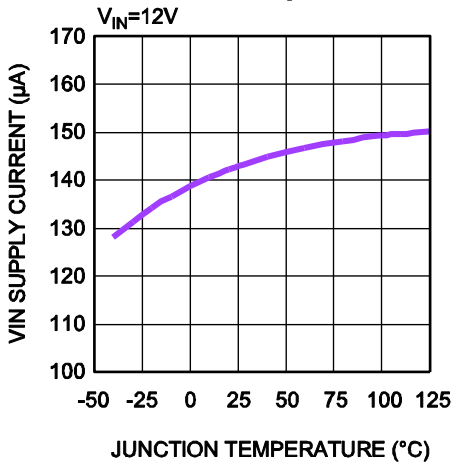
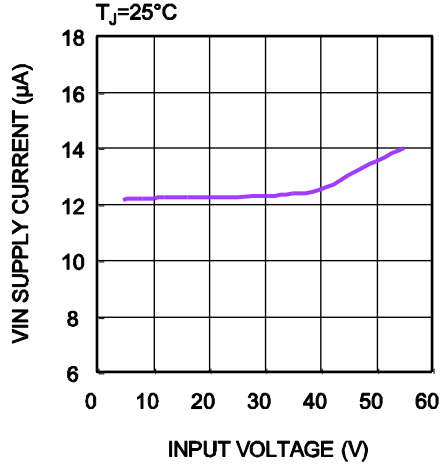
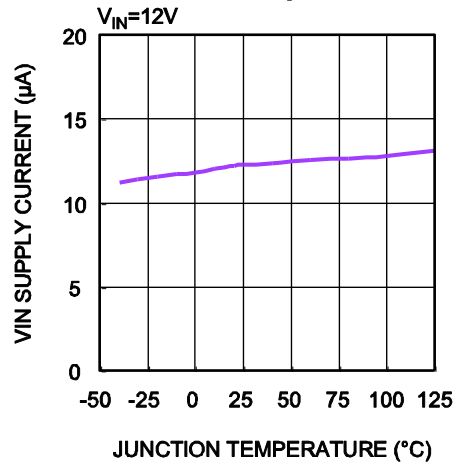
**TYPICAL CHARACTERISTICS** *(continued)*
**Frequency vs. Junction Temperature**

**Frequency vs. Feedback Voltage**

 **$V_{IN}$  Quiescent Current vs. Input Voltage**

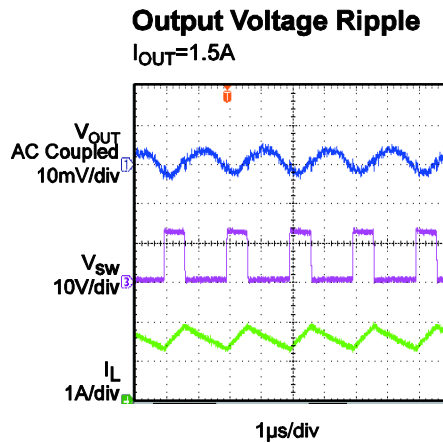
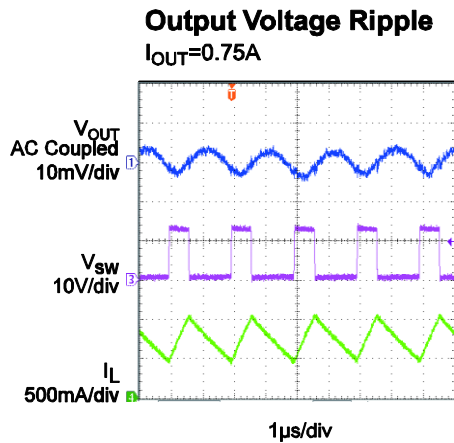
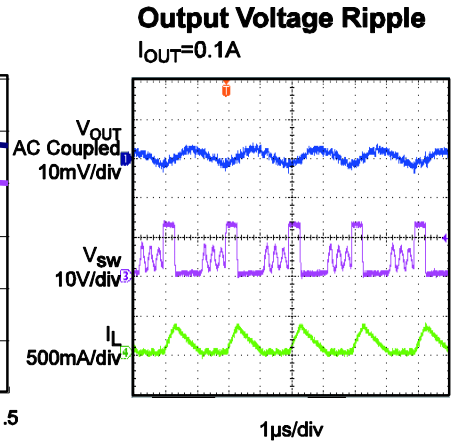
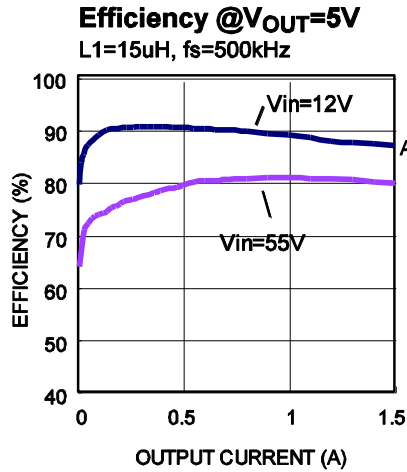
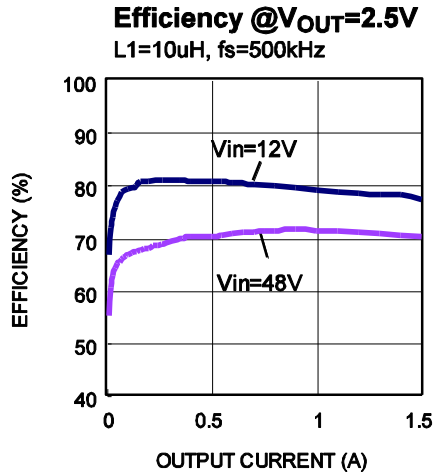
 **$V_{IN}$  Quiescent Current vs. Junction Temperature**

**Shutdown Current vs. Input Voltage**

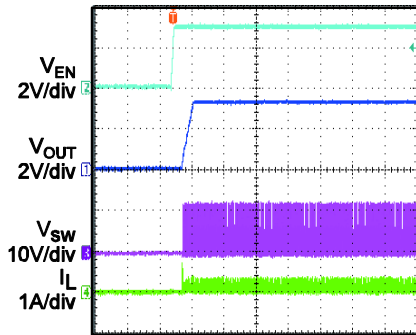
**Shutdown Current vs. Junction Temperature**

## TYPICAL PERFORMANCE CHARACTERISTICS

$V_{IN} = 12V$ ,  $V_{OUT} = 3.3V$ ,  $C1 = 10\mu F$ ,  $C2 = 22\mu F$ ,  $L1 = 10\mu H$  and  $T_A = +25^\circ C$ , unless otherwise noted.



**TYPICAL PERFORMANCE CHARACTERISTICS** *(continued)*
 $V_{IN} = 12V$ ,  $V_{OUT} = 3.3V$ ,  $C1 = 10\mu F$ ,  $C2 = 22\mu F$ ,  $L1 = 10\mu H$  and  $T_A = +25^\circ C$ , unless otherwise noted.

**Start up**
 $I_{OUT} = 0.1A, C5 = 10nF$ 

4ms/div

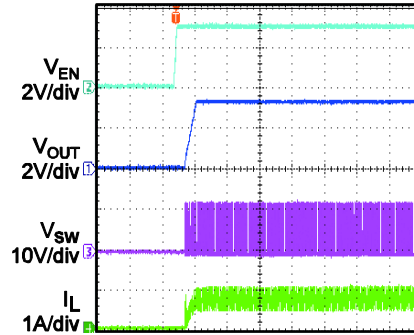
**Start up**
 $I_{OUT} = 0.75A, C5 = 10nF$ 

4ms/div

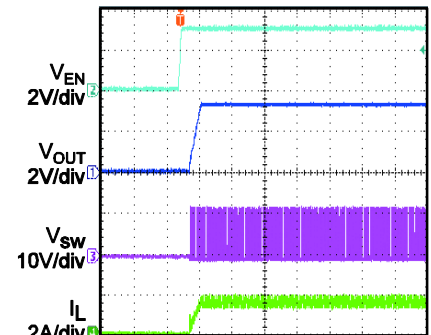
**Start up**
 $I_{OUT} = 1.5A, C5 = 10nF$ 

4ms/div

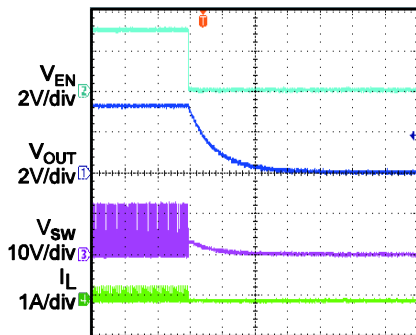
**Shut down**
 $I_{OUT} = 0.1A$ 

1ms/div

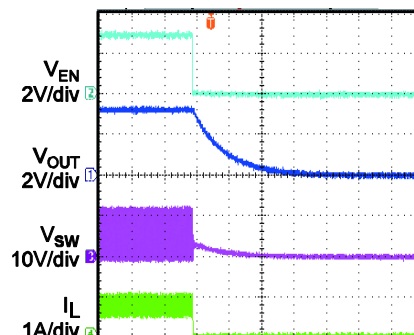
**Shut down**
 $I_{OUT} = 0.75A$ 

100µs/div

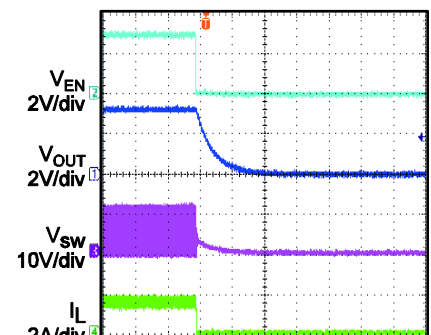
**Shut down**
 $I_{OUT} = 1.5A$ 

100µs/div

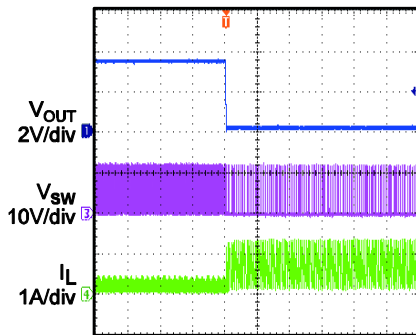
**Short Circuit Entry**
 $I_{OUT} = 0.1A$  to short

400µs/div

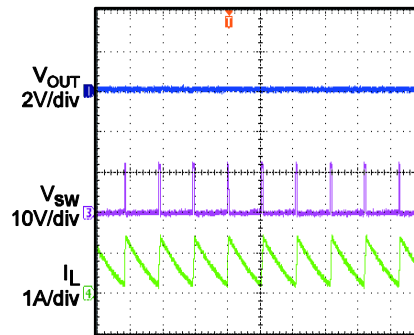
**Short Circuit Steady State**

20µs/div

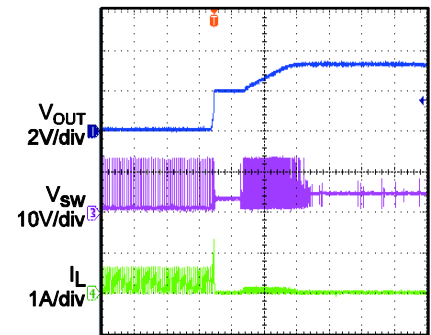
**Short Circuit Recovery**
 $I_{OUT} = \text{short to } 0A$ 

400µs/div



**BLOCK DIAGRAM**

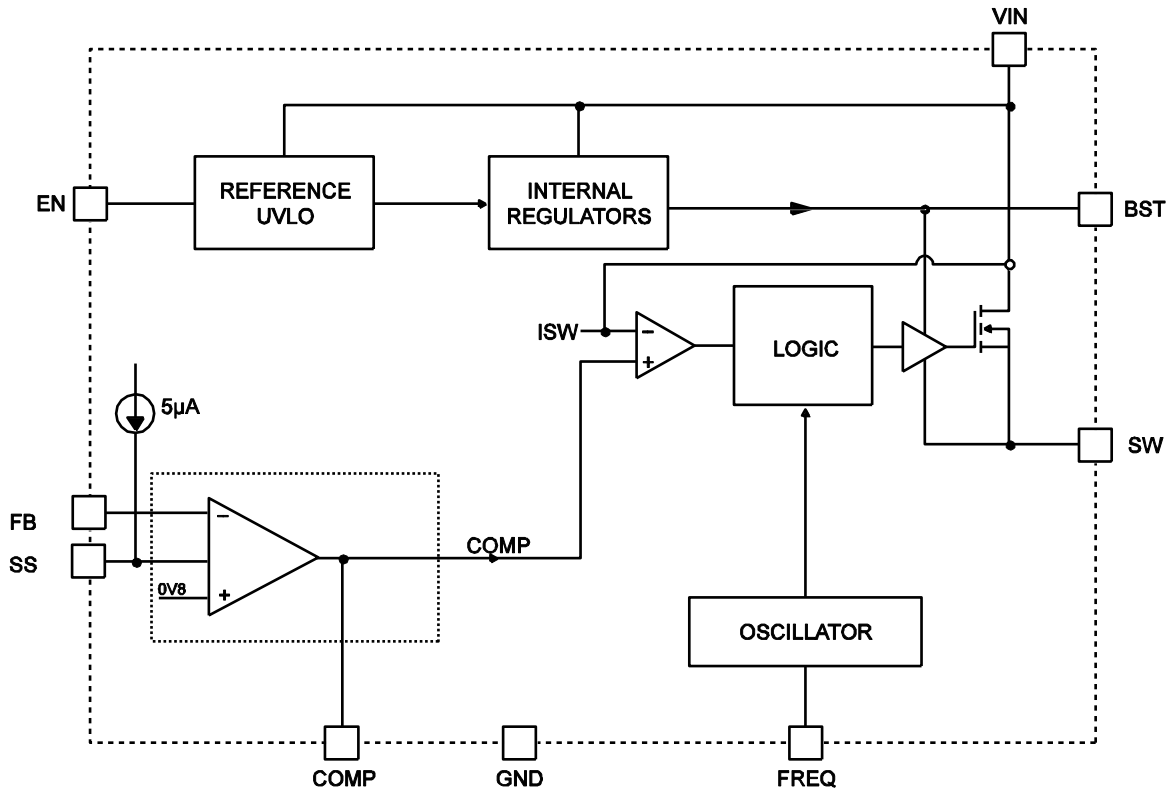

**Figure 1: Functional Block Diagram**

## OPERATION

The MPQ4561 is a programmable-frequency, non-synchronous, step-down, switching regulator with an integrated high-side high-voltage power MOSFET. It provides a single highly efficient solution with current mode control for fast loop response and easy compensation. It features a wide input voltage range, external soft-start control for start-up ramp-up flexibility, and precision current limiting. Its very low operational quiescent current makes it suitable for battery powered applications.

### PWM Control Mode

At moderate to high output current, the MPQ4561 operates in a fixed frequency, peak current control mode to regulate the output voltage. The internal clock initiates a PWM cycle. The power MOSFET turns on and remains on until its current reaches the value set by the COMP voltage. When the power MOSFET is off, it remains off for at least 100ns before the next cycle starts. If, in one PWM period, the power MOSFET current does not reach the COMP set current value, the power MOSFET remains on to saves on a turn-off operation.

### Pulse Skipping Mode

Under light load condition the switching frequency drops zero to reduce the switching loss and driving losses.

### Error Amplifier

The error amplifier compares the FB pin voltage with the internal reference (REF) and outputs a current proportional to the difference between the two. This output current then charges the external compensation network to form the COMP voltage, which controls the power MOSFET current.

While in operation, the minimum COMP voltage is clamped to 0.9V and its maximum is clamped to 2.0V. COMP is internally pulled down to GND in shutdown mode. Avoid pulling COMP up beyond 2.6V.

### Internal Regulator

The 2.6V internal regulator powers most of the internal circuits. This regulator takes the VIN input and operates in the full VIN range. When VIN exceeds 3.0V, the output of the regulator is in

full regulation: When VIN is less than 3.0V, the output drops to 0V.

### Enable Control

The MPQ4558 has a dedicated enable control pin (EN): An input voltage that exceeds an upper threshold enables the chip, while a voltage that drops below a lower threshold disables the chip. Its falling threshold is precisely 1.2V, and its rising threshold is 300mV higher, or 1.5V.

When floating, EN is pulled up to about 3.0V by an internal 1μA current source to enable the chip. Pulling it down requires a 1μA current.

When EN drops below 1.2V, the chip enters the lowest shutdown current mode. When EN exceeds 0V but remains below its rising threshold, the chip is still in shutdown mode but with a slightly higher shutdown current.

### Under-Voltage Lockout

Under-voltage lockout (UVLO) protects the chip from operating at an insufficient supply voltage. The UVLO rising threshold is about 3.0V while its falling threshold is a consistent 2.6V.

### Thermal Shutdown

Thermal shutdown prevents the chip from operating at exceedingly high temperatures. When the silicon die temperature exceeds its upper threshold, it shuts down the whole chip. When the temperature falls below its lower threshold, the chip is enabled again.

### Floating Driver and Bootstrap Charging

An external bootstrap capacitor powers the floating power MOSFET driver. This floating driver has its own UVLO protection with a rising threshold of 2.5V and a hysteresis of 300mV. The driver's UVLO is connected to the SS: If the bootstrap voltage hits its UVLO, the soft-start circuit resets. To prevent noise, there is 20μs delay before the reset action. When the device exits the bootstrap UVLO condition, the reset turns off and then soft-start process resumes.

The dedicated internal bootstrap regulator charges and regulates the bootstrap capacitor to about 5V. When the voltage between the BST and SW nodes falls below regulation, a PMOS pass transistor connected from VIN to BST turns on. The charging current path goes from VIN, to BST and then to SW. The external circuit must

provide enough voltage headroom to facilitate charging.

As long as  $V_{IN}$  is sufficiently higher than SW, the bootstrap capacitor will charge. When the power MOSFET is ON,  $V_{IN}$  is about equal to SW so the bootstrap capacitor cannot charge. When the external diode is on, the difference between  $V_{IN}$  and SW is at its largest, thus making it the best period to charge. When there is no current in the inductor, SW equals the output voltage  $V_{OUT}$  so the difference between  $V_{IN}$  and  $V_{OUT}$  can charge the bootstrap capacitor.

Under higher duty-cycle operation conditions, the time period available for bootstrap charging is smaller so the bootstrap capacitor may not sufficiently charge.

In case the internal circuit does not have sufficient voltage and the bootstrap capacitor is not charged, extra external circuitry can ensure the bootstrap voltage is in the normal operational region. Refer to the External Bootstrap Diode in Application section.

The DC quiescent current of the floating driver is about  $20\mu A$ . Make sure the bleeding current at the SW node is higher than this value, such that:

$$I_o + \frac{V_o}{(R1+R2)} > 20\mu A$$

### Current-Comparator and Current Limit

A current-sense MOSFET accurately senses the current in the power MOSFET. This signal is then fed to the high speed current comparator for current-mode-control purposes, which uses it as one of its inputs with the COMP voltage. When the power MOSFET turns on, the comparator is first blanked until the end of the turn-on transition to avoid noise issues. When the sensed current exceeds the COMP voltage, the comparator output is low and the power MOSFET turns off. The cycle-by-cycle maximum current of the internal power MOSFET is internally limited.

### Short Circuit Protection

When the output is shorted to the ground, the switching frequency folds back and the current limit falls to reduce the short circuit current. When the FB voltage equals 0V, the current limit falls to about 50% of its full current limit. The FB voltage reaches its 100% of its current limit when it exceeds 0.4V

When the short-circuit FB voltage is low, the SS drops by  $V_{FB}$  and  $SS \approx V_{FB} + 100mV$ . If the short circuit is removed, the output voltage recovers at the SS rate. When FB is high enough, the frequency and current limit return to normal values.

### Startup and Shutdown

If both  $V_{IN}$  and  $V_{EN}$  exceed their appropriate thresholds, the chip starts. The reference block starts first, generating stable reference voltage and currents, and then the internal regulator is enabled. The regulator provides stable supply for the remaining circuits.

While the internal supply rail is up, an internal timer blanks the power MOSFET OFF for about  $50\mu s$  to avoid start-up glitches. When the internal soft-start block is enabled, it first holds its SS output low to ensure the other circuits are ready and then slowly ramps up.

Three events can shut down the chip: EN low,  $V_{IN}$  low and thermal shutdown. In the shutdown procedure, power MOSFET is turned off first to avoid any fault triggering. The COMP voltage and the internal supply rail are then pulled down.

### Programmable Oscillator

An external resistor ( $R_{FREQ}$ ) connected from the FREQ pin to GND sets the MPQ4558 oscillating frequency. Calculate the value of  $R_{FREQ}$  from:

$$R_{FREQ}(k\Omega) = \frac{100000}{f_s(kHz)} - 5$$

For  $f_{SW}=500kHz$ ,  $R_{FREQ}=195k\Omega$ .

### Soft-Start

Soft-start prevents the converter output voltage from overshooting during startup and short circuit recovery phases. Internally the soft-start voltage ( $V_{SS}$ ) is the voltage at SS pin offset by about 1V.  $V_{SS}$  is applied on the error amplifier in parallel with the internal reference voltage REF.  $V_{SS}$  or REF (whichever is lower) controls the error amplifier. When  $V_{SS}$  ramps up from 0 to high, the controller tries to regulate FB from zero to REF at the  $V_{SS}$  ramp-up pace.

A  $5\mu A$  current source pulls up the SS pin. Given the soft-start capacitor ( $C_{SS}$ ), the soft-start time is about the time  $C_{SS}$  voltage changes by 0.8V. So the soft-start time can be estimated as:

$$t_{ss} = \frac{C_{ss} \times 0.8V}{5\mu A}$$

**Soft-start Time vs.  
Soft-start Capacitance**

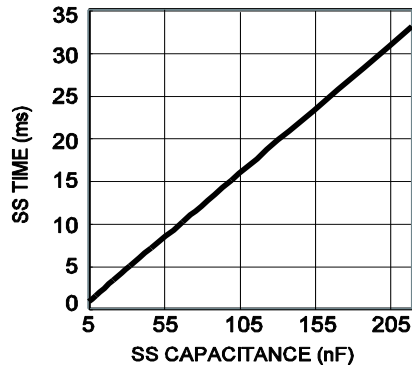

**Figure 2: Recommend SS time vs SS Capacitance**

Figure 2 shows the soft-start time with different external soft-start capacitance. The typical soft-start capacitance is recommended from 5.6nF to 220nF.

## APPLICATION INFORMATION

### COMPONENT SELECTION

#### Setting the Output Voltage

Set the output voltage with a resistor divider between the output voltage and the FB pin. The voltage divider drops the output voltage down to the feedback voltage by the ratio:

$$V_{FB} = V_{OUT} \times \frac{R2}{R1+R2}$$

Thus the output voltage is:

$$V_{OUT} = V_{FB} \times \frac{R1+R2}{R2}$$

For example, for  $R2 = 10k\Omega$ ,  $R1$  can be determined by:

$$R1 = 12.5 \times (V_{OUT} - 0.8) (k\Omega)$$

For example, for a 3.3V output voltage,  $R2$  is  $10k\Omega$ , and  $R1$  is  $31.6k\Omega$ .

#### Inductor

The inductor supplies constant current to the output load while being driven by the switched input voltage. A larger value inductor will result in less ripple current that will lower the output ripple voltage. However, a larger-valued inductor is physically larger, has a higher series resistance, or lower saturation current.

Generally, determine an appropriate inductance value by selecting the peak-to-peak inductor ripple current equal to approximately 30% of the maximum switch current limit. Also, make sure that the peak inductor current is below the maximum switch current limit. Calculate the inductance value with:

$$L1 = \frac{V_{OUT}}{f_s \times \Delta I_L} \times \left(1 - \frac{V_{OUT}}{V_{IN}}\right)$$

Where:

- $V_{OUT}$  is the output voltage,
- $V_{IN}$  is the input voltage,
- $f_s$  is the switching frequency, and
- $\Delta I_L$  is the peak-to-peak inductor ripple current.

Choose an inductor that will not saturate under the maximum inductor peak current. Calculate the peak inductor current with:

$$I_{LP} = I_{LOAD} + \frac{V_{OUT}}{2 \times f_s \times L1} \times \left(1 - \frac{V_{OUT}}{V_{IN}}\right)$$

Where  $I_{LOAD}$  is the load current.

Table 1 lists a number of suitable inductors from various manufacturers. The choice the inductor style mainly depends on the price vs. size requirements and any EMI requirement.

#### Output Rectifier Diode

The output rectifier diode supplies the current to the inductor when the high-side switch is off. To reduce losses due to the forward diode voltage and recovery times, use a Schottky diode.

Choose a diode whose maximum reverse voltage rating is greater than the maximum input voltage, and whose current rating is greater than the maximum load current. Table 2 lists example Schottky diodes and manufacturers.

**Table 1: Inductor Selection Guide**

Part Number	Inductance (µH)	Max DCR (Ω)	Current Rating (A)	Dimensions L x W x H (mm <sup>3</sup> )
<b>Würth Electronics</b>				
7447789004	4.7	0.033	2.9	7.3x7.3x3.2
744066100	10	0.035	3.6	10x10x3.8
744771115	15	0.025	3.75	12x12x6
744771122	22	0.031	3.37	12x12x6
<b>TDK</b>				
RLF7030T-4R7	4.7	0.031	3.4	7.3x6.8x3.2
SLF10145T-100	10	0.0364	3	10.1x10.1x4.5
SLF12565T-150M4R2	15	0.0237	4.2	12.5x12.5x6.5
SLF12565T-220M3R5	22	0.0316	3.5	12.5x12.5x6.5
<b>Toko</b>				
FDV0630-4R7M	4.7	0.049	3.3	7.7x7x3
919AS-100M	10	0.0265	4.3	10.3x10.3x4.5
919AS-160M	16	0.0492	3.3	10.3x10.3x4.5
919AS-220M	22	0.0776	3	10.3x10.3x4.5

**Table 2: Diode Selection Guide**

Diodes	Voltage/Current Rating	Manufacturer
B290-13-F	90V, 2A	Diodes Inc.
B380-13-F	80V, 3A	Diodes Inc.
CMSH2-100M	100V, 2A	Central Semi
CMSH3-100MA	100V, 3A	Central Semi

### Input Capacitor

The input current to the step-down converter is discontinuous and therefore requires a capacitor to supply the AC current to the step-down converter while maintaining the DC input voltage. Use capacitors with low equivalent series resistance (ESR) for the best performance. Ceramic capacitors are preferred, but tantalum or low-ESR electrolytic capacitors may also suffice.

For simplification, choose the input capacitor with an RMS current rating greater than half of the maximum load current. The input capacitor (C1) can be electrolytic, tantalum or ceramic.

When using electrolytic or tantalum capacitors, include a small, high-quality ceramic capacitor—i.e. 0.1µF—placed as close to the IC as possible. When using ceramic capacitors, make sure that they have enough capacitance to provide sufficient charge to prevent excessive voltage ripple at the input. The input voltage ripple caused by the capacitance can be estimated by:

$$\Delta V_{IN} = \frac{I_{LOAD}}{f_s \times C1} \times \frac{V_{OUT}}{V_{IN}} \times \left( 1 - \frac{V_{OUT}}{V_{IN}} \right)$$

### Output Capacitor

The output capacitor (C2) maintains the DC output voltage. Use ceramic, tantalum, or low-ESR electrolytic capacitors for best results. Low ESR capacitors are preferred to keep the output voltage ripple low. The output voltage ripple can be estimated by:

$$\Delta V_{OUT} = \frac{V_{OUT}}{f_s \times L} \times \left(1 - \frac{V_{OUT}}{V_{IN}}\right) \times \left(R_{ESR} + \frac{1}{8 \times f_s \times C2}\right)$$

Where L is the inductor value and  $R_{ESR}$  is the equivalent series resistance (ESR) value of the output capacitor.

For ceramic capacitors, the impedance at the switching frequency is dominated by the capacitance. The output voltage ripple is mainly caused by the capacitance. For simplification, the output voltage ripple can be estimated by:

$$\Delta V_{OUT} = \frac{V_{OUT}}{8 \times f_s^2 \times L \times C2} \times \left(1 - \frac{V_{OUT}}{V_{IN}}\right)$$

For tantalum or electrolytic capacitors, the ESR dominates the impedance at the switching frequency. For simplification, the output ripple can be approximated as:

$$\Delta V_{OUT} = \frac{V_{OUT}}{f_s \times L} \times \left(1 - \frac{V_{OUT}}{V_{IN}}\right) \times R_{ESR}$$

The characteristics of the output capacitor also affect the stability of the regulation system. The MPQ4561 can be optimized for a wide range of capacitance and ESR values.

### Compensation Components

MPQ4558 employs current-mode control for easy compensation and fast transient response. The COMP pin controls the system stability and transient response—the COMP pin is the output of the internal error amplifier. A capacitor-resistor combination in series sets a pole-zero combination to control the characteristics of the control system. The DC gain of the voltage feedback loop is given by:

$$A_{VDC} = R_{LOAD} \times G_{CS} \times A_{VEA} \times \frac{V_{FB}}{V_{OUT}}$$

Where

- $A_{VEA}$  is the error amplifier voltage gain, 400V/V,
- $G_{CS}$  is the current sense transconductance, 4.5A/V, and
- $R_{LOAD}$  is the load resistor value.

The system has two poles of importance: One is caused by the compensation capacitor (C3) and the output resistor of error amplifier; the other is caused by the output capacitor and the load resistor. These poles are located at:

$$f_{P1} = \frac{G_{EA}}{2\pi \times C3 \times A_{VEA}}$$

$$f_{P2} = \frac{1}{2\pi \times C2 \times R_{LOAD}}$$

Where,  $G_{EA}$  is the error amplifier transconductance, 120 $\mu$ A/V.

The system has one zero of importance, from C3 and the compensation resistor (R3). This zero is located at:

$$f_{Z1} = \frac{1}{2\pi \times C3 \times R3}$$

The system may have another important zero if the output capacitor has a large capacitance or a high ESR value. The zero, due to the ESR and the output capacitor value, is located at:

$$f_{ESR} = \frac{1}{2\pi \times C2 \times R_{ESR}}$$

In this case, a third pole set by the compensation capacitor (C6) and R3 compensates for the effect of the ESR zero on the loop gain. This pole is located at:

$$f_{P3} = \frac{1}{2\pi \times C6 \times R3}$$

The compensation network shapes the converter transfer function for a desired loop gain. The feedback-loop unity gain at the system crossover frequency is important: Lower crossover frequencies result in slower line and load

transient responses, while higher crossover frequencies can destabilize the system. Generally, set the crossover frequency to approximately 1/10 of the switching frequency

**Table 3: Compensation Values for Typical Output Voltage/Capacitor Combinations**

V <sub>OUT</sub> (V)	L (μH)	C2 (μF)	R3 (kΩ)	C3 (pF)	C7 (pF)
1.8	4.7	47	62	1000	47
2.5	4.7 - 6.8	22	36	680	None
3.3	6.8 - 10	22	51	470	None
5	15 - 22	33	82	680	None
12	10	33	40.2	330	2

To optimize the compensation components for conditions not listed in Table 3 use the following procedure.

1. Choose the compensation resistor (R3) to set the desired crossover frequency. Determine the R3 value from the following equation:

$$R3 = \frac{2\pi \times C2 \times f_c}{G_{EA} \times G_{CS}} \times \frac{V_{OUT}}{V_{FB}}$$

Where  $f_c$  is the desired crossover frequency.

2. Choose C3 to achieve the desired phase margin. For applications with typical inductor values, setting the compensation zero ( $f_{z1}$ ) below 1/4 of the crossover frequency to provide sufficient phase margin. Determine the C3 from the following equation:

$$C3 > \frac{4}{2\pi \times R3 \times f_c}$$

3. Determine if C6 is required—if the ESR zero of the output capacitor is located at less than half of the switching frequency, or if the following relationship is valid:

$$\frac{1}{2\pi \times C2 \times R_{ESR}} < \frac{f_s}{2}$$

If this is the case, then add C6 to set the pole  $f_{p3}$  at the location of the ESR zero. Determine the C6 value by the equation:

$$C6 = \frac{C2 \times R_{ESR}}{R3}$$

### High Frequency Operation

The MPQ4561 switching frequency can be programmed up to 2MHz by an external resistor.

The minimum MPQ4561 ON-time of is typically about 100ns. Pulse-skipping operation can be seen more easily at higher switching frequencies due to the minimum on time.

Since the internal bootstrap circuitry has higher impedance that may not be adequate to charge the bootstrap capacitor during each  $(1-D) \times t_s$  charging period, add an external bootstrap charging diode if the switching frequency is about 2MHz (see External Bootstrap Diode section for detailed implementation information).

With higher switching frequencies, the inductive reactance (XL) of the capacitor dominates, so that the ESL of the input/output capacitor determines the input/output ripple voltage at higher switching frequencies. Because of this ripple, use high-frequency ceramic capacitors for the input decoupling capacitor and output the filtering capacitor for high-frequency operation.

Layout becomes more important when the device switches at higher frequencies. For best results, place the input decoupling capacitor and the catch diode as close to the MPQ4561 (VIN pin, SW pin and PGND) as possible, with short and wide traces. This can help to greatly reduce the voltage spike on SW node, and lower the EMI noise level as well.

Route the feedback trace as far from the inductor and noisy power traces as possible. If possible, run the feedback trace on the opposite side of the PCB from the inductor with a ground plane separating the two.

Place the compensation components close to the MPQ4561. Do not place the compensation components close to or under high dv/dt SW node, or inside the high di/dt power loop. If this is necessary, add a ground plane to isolate them.



Switching loss is expected to be increased at high switching frequency.

To help to improve the thermal conduction, add grid of thermal vias under the exposed pad. use small vias (15mil barrel diameter) so that the plating process fills the holes, thus aiding conduction to the other side. Excessively large holes can cause solder wicking during the reflow soldering process. The typical pitch (distance between the centers) between thermal vias is typically 40mil.

### External Bootstrap Diode

An external bootstrap diode may enhance the regulator efficiency. For the cases described below, add an external BST diode from 5V to the BST pin:

- There is a 5V rail available in the system;
- $V_{IN}$  is no greater than 5V;
- $V_{OUT}$  is between 3.3V and 5V;

This diode is also recommended for high duty cycle operation (when  $V_{OUT} / V_{IN} > 65\%$ ) applications.

The bootstrap diode can be a low cost one such as IN4148 or BAT54.

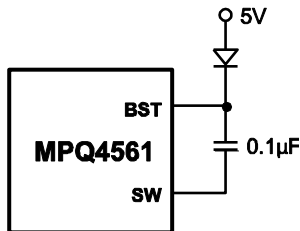

**Figure 3: External Bootstrap Diode**

At no load or light load, the converter may operate in pulse skipping mode to maintain the output voltage in regulation: There is less time to refresh the BST voltage. For sufficient gate voltage under such operating conditions, chose ( $V_{IN} - V_{OUT}$ ) greater than 3V. For example, if the  $V_{OUT}$  is 3.3V,  $V_{IN}$  needs exceed  $3.3V + 3V = 6.3V$  to maintain enough BST voltage at no load or light load. To meet this requirement, EN pin can be used to program the input UVLO voltage to  $V_{out} + 3V$ .

## TYPICAL APPLICATION CIRCUITS

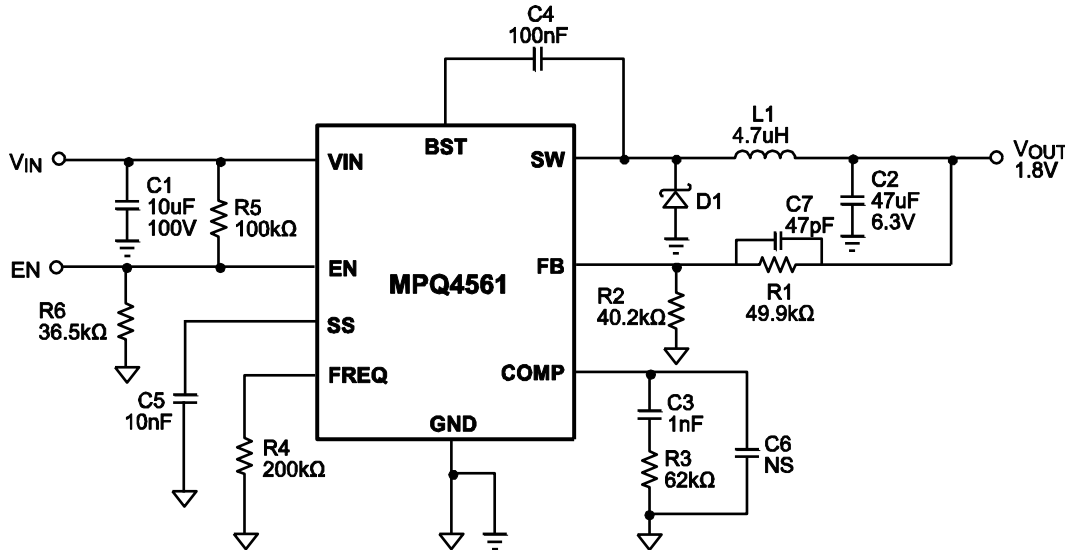

Figure 4: 1.8V Output Typical Application Schematic

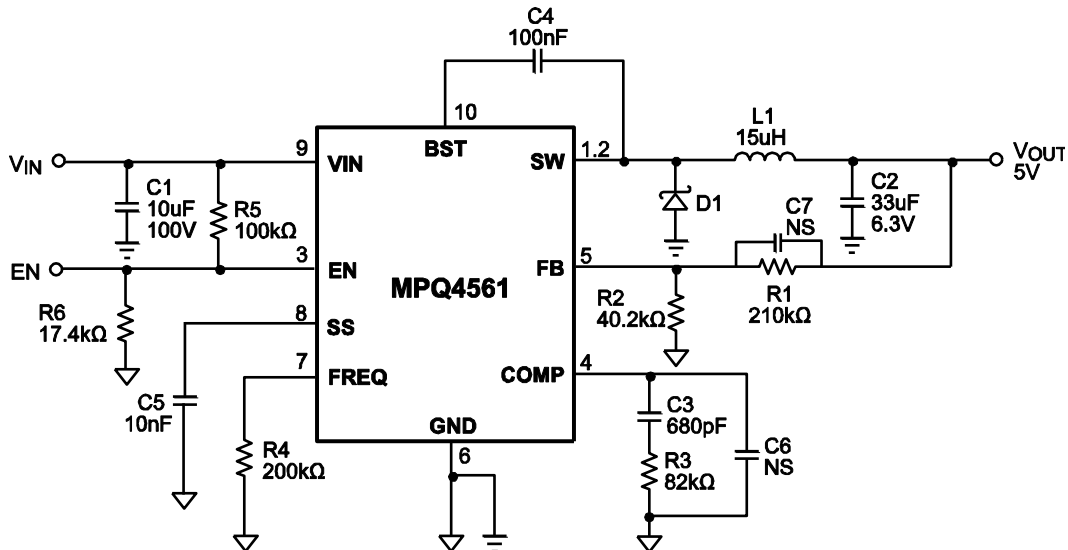

Figure 5: 5V Output Typical Application Schematic

## PCB Layout Guide

PCB layout is very important to achieve stable operation. Duplicate the EVB layout below for optimal performance.

For changes, please follow these guidelines and use Figure 6 as reference.

1. Keep the switching-current path short and minimize the loop area formed by the input capacitor, high-side MOSFET and external switching diode.

2. Place the bypass ceramic capacitors close to the  $V_{IN}$  pin.
3. Use short and direct feedback connections. Place the feedback resistors and compensation components as close to the chip as possible.
4. Route the SW path away from sensitive analog areas such as the FB path.
5. Connect IN, SW, and GND, respectively, to a large copper area to cool the chip to improve thermal performance and long-term reliability

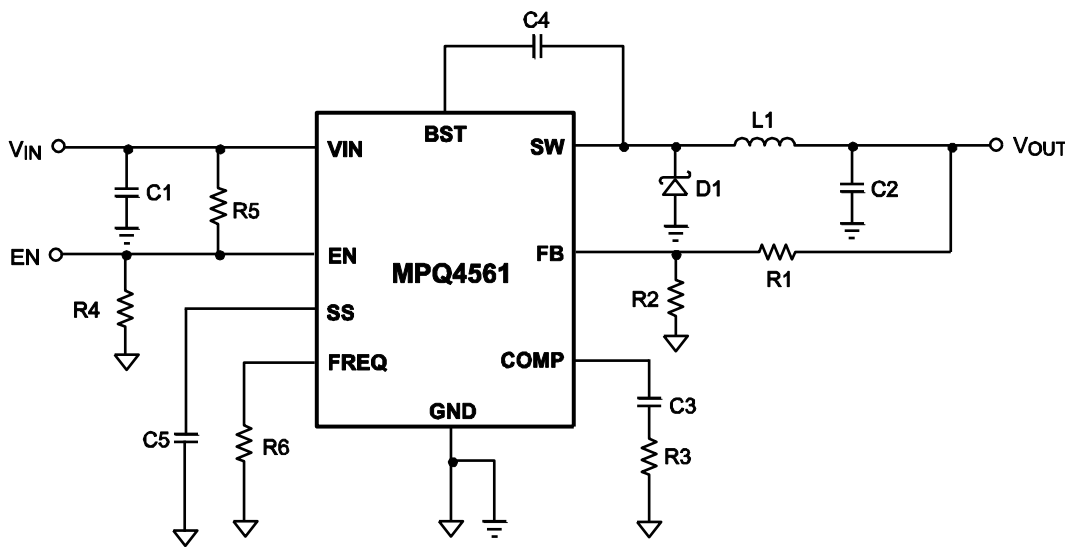

**MPQ4561 Typical Application Circuit**

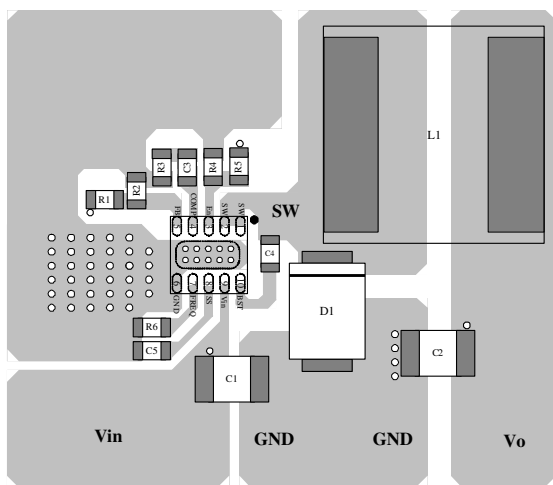

**TOP Layer**

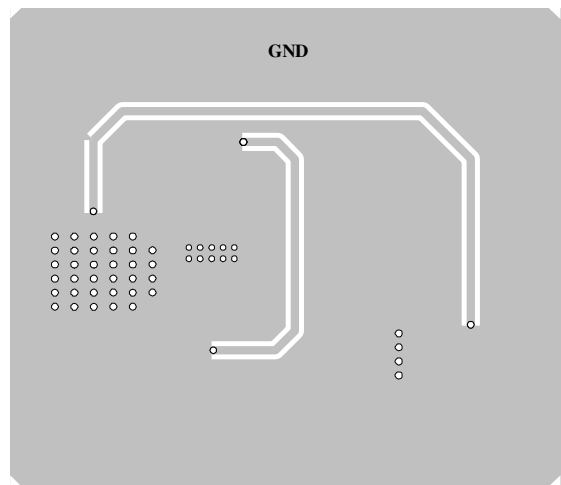

**Bottom Layer**

**Figure 6: MPQ4561DQ Typical Application Circuit and PCB Layout Guide**

## PACKAGE INFORMATION

### QFN10 (3x3mm) (Exposed Pad)

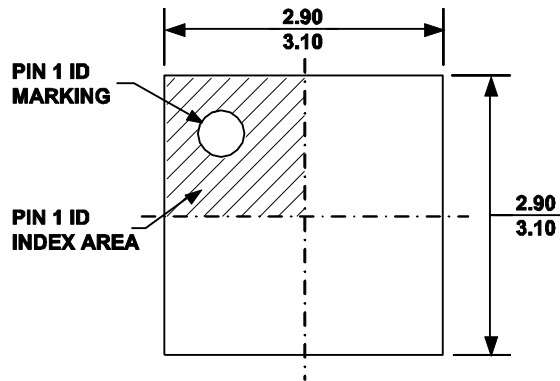

**TOP VIEW**

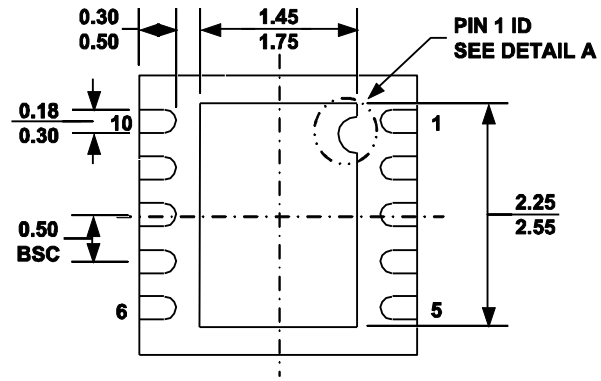

**BOTTOM VIEW**

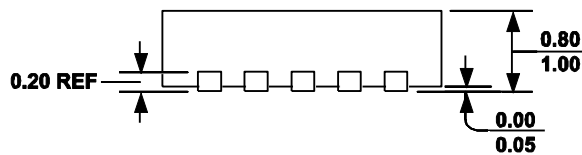

**SIDE VIEW**

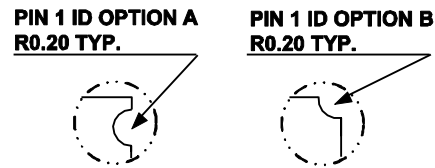

**DETAIL A**

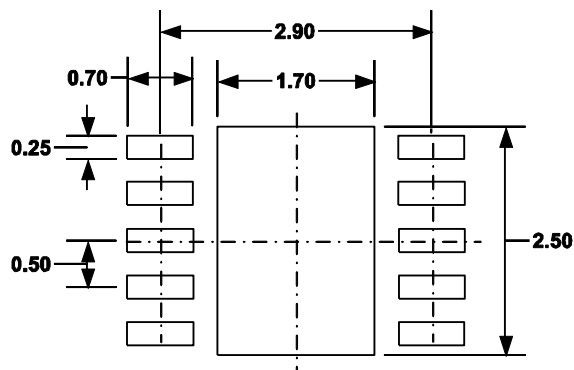

**RECOMMENDED LAND PATTERN**

#### NOTE:

- 1) ALL DIMENSIONS ARE IN MILLIMETERS.
- 2) EXPOSED PADDLE SIZE DOES NOT INCLUDE MOLD FLASH.
- 3) LEAD COPLANARITY SHALL BE 0.10 MILLIMETER MAX.
- 4) DRAWING CONFORMS TO JEDEC MO-229, VARIATION VEED-5.
- 5) DRAWING IS NOT TO SCALE.

**NOTICE:** The information in this document is subject to change without notice. Users should warrant and guarantee that third party Intellectual Property rights are not infringed upon when integrating MPS products into any application. MPS will not assume any legal responsibility for any said applications.