

REVISIONS					
REV	ECO	DESCRIPTION	DATE	BY	APPR
A1	-	RELEASE DRAWING	04JAN21	SULLEN	TOMMY
A2	-	UPDATE DRAWING	10MAY21	SULLEN	TOMMY

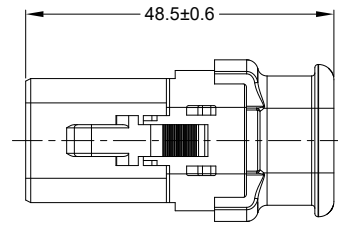

REQUIRES CONTACT RETENTION WEDGE AWP-6S

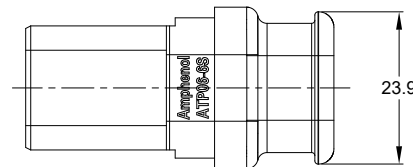
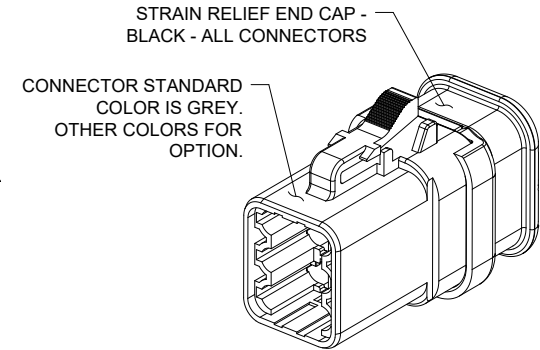
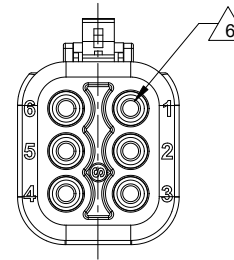
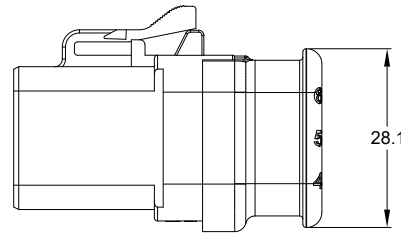
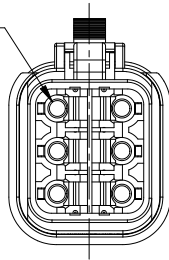

NOTES: UNLESS OTHERWISE SPECIFIED

- MATERIAL:  
HOUSING: THERMOPLASTIC; COLOR: SEE PART NUMBER CHART  
STRAIN RELIEF: THERMOPLASTIC; COLOR: BLACK  
SEAL: SILICONE RUBBER; COLOR: RED FOR STANDARD, YELLOW FOR REDUCED DIA.
- MODIFICATIONS: REDUCED DIAMETER WIRE SEAL (OPT), STRAIN RELIEF END CAP
- SPECIFICATIONS:  
3.1 CURRENT RATING: 25 AMPS  
3.2 OPERATING TEMPERATURE: -55°C TO +125°C  
3.3 DIELECTRIC WITHSTANDING VOLTAGE: LESS THAN 2 MILLIAMPS CURRENT LEAKAGE @ 1500 VOLTS AC.  
3.4 INSULATION RESISTANCE: 1000 MEGOHMS MIN @ 25°C.  
3.5 MOISTURE RESISTANCE: IP68 (1M OF WATER FOR A PERIOD OF 24 HOURS, MATED CONDITION)  
3.6 MATING CYCLE DURABILITY: 100 CYCLES  
3.7 RoHS COMPLIANT
- MATING PART: ATP04-6P\* RECEPTACLE.  
(\* = MODIFICATIONS AND COLORS)
- ALL DIMENSIONS ARE FOR REFERENCE USE ONLY.

△ 6. CONTACT SIZE AND REAR SEAL WIRE RANGE:

STANDARD SEAL:

CONTACT SIZE	MIN. INSUL O.D.	MAX. INSUL O.D.	TYPICAL WIRE RANGE
12	3.40 mm (.134 in)	4.95 mm (.195 in)	10 - 14 AWG (5.0-2.0mm <sup>2</sup> )

REDUCED DIAMETER SEAL:

CONTACT SIZE	MIN. INSUL O.D.	MAX. INSUL O.D.	TYPICAL WIRE RANGE
12	2.46 mm (.097 in)	4.01 mm (.158 in)	12 - 14 AWG (3.0-2.0mm <sup>2</sup> )

PART NUMBER CHART				
PART NUMBER	SEAL	HOUSING COLOR	STRAIN RELIEF COLOR	WEIGHT (GRAMS)
ATP06-6S-SR01	STANDARD	GREY	BLACK	20.5
ATP06-6S-SR01BK	STANDARD	BLACK	BLACK	20.5
ATP06-6S-SR02	REDUCED DIA.	GREY	BLACK	20.5
ATP06-6S-SR02BK	REDUCED DIA.	BLACK	BLACK	20.5





ATP06-6S-SR0X		DESCRIPTION		ITEM
QUANTITY	PART NUMBER	MATERIALS LIST		
UNLESS OTHERWISE SPECIFIED 1) All dimensions are in metric(mm). 2) Tolerances are as follows: 1 PL DEC ±0.30 Fractions ±1/64 2 PL DEC ±0.15 Angles ±1° 3 PL DEC ±0.08				
SIGNATURES		DATE		
DRAWN: SULLEN.ZHANG		10MAY21		
CHECKED: ORION.LI		11MAY21		
ENGINEER:		APPROVAL: TOMMY.XIE 12MAY21		
MATERIAL SPECIFICATIONS:		CUSTOMER:		
PROCESS SPECIFICATIONS:		THIS DRAWING IS SUPPLIED FOR INFORMATION ONLY. DESIGN FEATURES, SPECIFICATIONS AND PERFORMANCE DATA SHOWN HEREON ARE THE PROPERTY OF THE AMPHENOL CORPORATION. NO RIGHTS OF REPRODUCTION ARE IMPLIED. ALL DIMENSIONS ARE SUBJECT TO NORMAL MANUFACTURING VARIATIONS.		
NEXT ASSY:		SIZE	TYPE	DWG NO.
		B	C-	ATP06-6S-SR0X
		SCALE: NONE		REVISION A2
				SHEET 1 OF 1

TITLE: 6 POS. PLUG, SOCKET, ATP SERIES, STRAIN RELIEF END CAP  
DWG NO.: ATP06-6S-SR0X  
REV: A2  
SH: 1  
OF: 1

# ATP Series™ - Contact Size 12 Options

Machined Contacts, Sockets & Pins				
Part Number	Description	Size	AWG	Type
AT60-204-12141-10	Male Contact - Pin, Nickel-plated	12	10-12	Machined
AT62-203-12141-10	Female Contact - Socket, Nickel-plated	12	10-12	Machined
AT60-220-1231	Male Contact - Pin, Gold-plated	12	12-14	Machined
AT62-210-1231	Female Contact - Socket, Gold-plated	12	12-14	Machined
AT60-204-12141	Male Contact - Pin, Nickel-plated	12	12-14	Machined
AT62-203-12141	Female Contact - Socket, Nickel-plated	12	12-14	Machined

DiagnosticGrade™ Machined Contacts, Sockets & Pins				
• Smaller AWG for Diagnostic Applications • Gold-plated • Increased Mating Cycles • Cost-effective				
Part Number	Description	Size	AWG	Type
65-54749	Male Contact - DiagnosticGrade™, Pin, Gold-plated	12	20	Machined
AT62-210-1231-1820	Female Contact - DiagnosticGrade™, Socket, Gold-plated	12	20	Machined

Tooling - Machined Contacts		
Part	Part Number	Description
	CA-5D12	Universal Hand Crimp Tool, Size 12/16/20 (Machined contacts only)
	CA-5E12	Pneumatic Crimp Tool, Size 12/16/20 (Machined contacts only)
	M300-25A	Hand Crimp Tool used with Crimp Locator MFX-3966, Size 12, 10AWG (Machined contacts only)
	MFX-3966	Contact Locator used with Hand Crimp Tool M300-25A, Size 12, 10AWG (Machined contacts only)

Contact Removal Tools		
Part	Part Number	Description
	ATRT-100	Used for removal of contacts for A Series™ products
	AT11-337-1205	Contact Removal Tool, Plastic, Size 12
	A114017	Sealing Plug, Size 12, White

Stamped & Formed Contacts, Sockets & Pins				
Part Number	Description	Size	AWG	Type
AT60-12-0244	Male Contact - Pin, Gold-plated	12	10-12	Stamped & Formed
AT62-12-0244	Female Contact - Socket, Gold-plated	12	10-12	Stamped & Formed
AT60-12-0222	Male Contact - Pin, Nickel-plated	12	10-12	Stamped & Formed
AT62-12-0222	Female Contact - Socket, Nickel-plated	12	10-12	Stamped & Formed
AT60-12-0144	Male Contact - Pin, Gold-plated	12	12-14	Stamped & Formed
AT62-12-0144	Female Contact - Socket, Gold-plated	12	12-14	Stamped & Formed
AT60-12-0166	Male Contact - Pin, Nickel-plated	12	12-14	Stamped & Formed
AT62-12-0166	Female Contact - Socket, Nickel-plated	12	12-14	Stamped & Formed

Tooling - Stamped & Formed Contacts		
Part	Part Number	Description
	MFX-3973	Crimp Die - Size 12 (S&F contacts only)
	MFX-3985	Crimp Die - Size 12 (S&F contacts only) 10-12AWG -02XX Series
	ATT-12-00	Hand Crimp Tool - Size 12, 12AWG (S&F contacts only)
	ATT-12-01	Hand Crimp Tool - Size 12, 10AWG (S&F contacts only)