

MATERIALS AND FINISHES

COUPLING NUT BRASS
PLATED GOLD

BODY BRASS
PLATED GOLD

CENTER CONTACT BeCu
PLATED GOLD

INSULATOR TEFLON

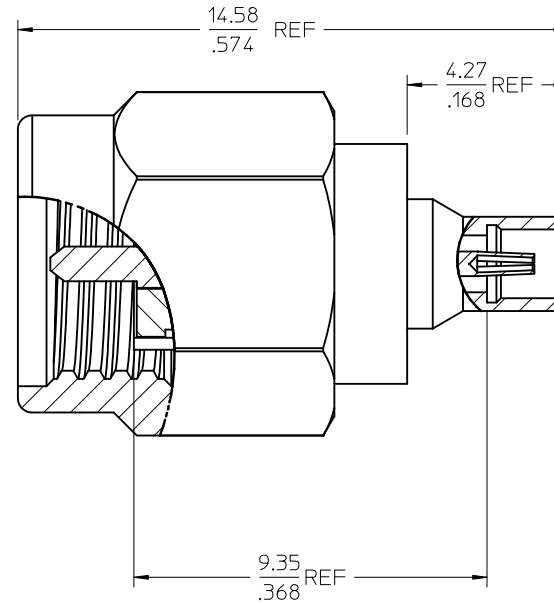
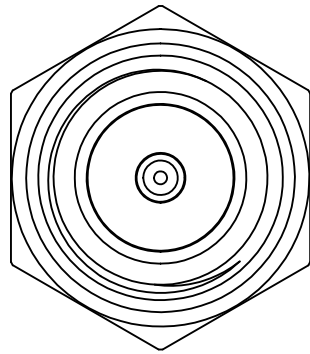
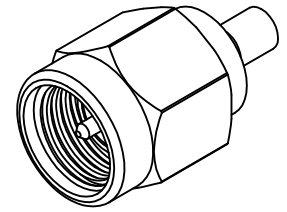

73386-0841	73386-0840 ONE PIECE PER BAG
73386-0840	STANDARD
PART NO.	PACKAGING

ES-73599-0009-0011	INTERFACE SSMCX JACK
MIL-STD-348A, FIG. 310.1	INTERFACE SMA PLUG
SPECIFICATION	DESCRIPTION

CHG: MATERIAL NO.
WAS 733860830.
ADDED -0841 SINGLE
BAG

EC NO: URF2011-0651
DRWN:JLEE02 2011/05/04
CHKD:SSS 2011/05/04
APPR:JWIENER 2011/05/05

QUALITY SYMBOLS
▽=0
▽=0

GENERAL TOLERANCES (UNLESS SPECIFIED)

	mm	INCH
4 PLACES	± .005	± .0002
3 PLACES	± .002	± .0001
2 PLACES	± 0.10	± .004
1 PLACE	± 0.13	± .005

ANGULAR ± 2 °

DRAFT WHERE APPLICABLE
MUST REMAIN
WITHIN DIMENSIONS

DIMENSION STYLE
MM/IN

DRAWN BY	DATE
JOHN	2004/12/12
CHECKED BY	DATE
JOHNSON	2004/12/12
APPROVED BY	DATE
MISEN	2004/12/12

MATERIAL NO.
SEE TABLE

SIZE
C

SCALE
METRIC

DESIGN UNITS
METRIC

THIRD ANGLE PROJECTION

TITLE
**SSMCX ADAPTER
SSMCX JACK TO SMA PLUG
BSA-SSMCX/SMA**

molex MOLEX INCORPORATED

DOCUMENT NO.
SD-73386-084

SHEET NO.
1 OF 1

THIS DRAWING CONTAINS INFORMATION THAT IS PROPRIETARY TO MOLEX
INCORPORATED AND SHOULD NOT BE USED WITHOUT WRITTEN PERMISSION