

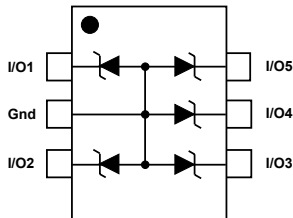

Automotive 5 lines TVS for ESD protection



SOT23-6L



Features

- AEC-Q101 qualified 
- 5 unidirectional TVS functions
- UL 94, V0
- J-STD-020 MSL level 1
- Benefit:
 - Suitable for high density boards
- Complies with the standard ISO 10605 / IEC 61000-4-2: C = 150 pF, R = 330 Ω
 - ±30 kV (air discharge)
 - ±18 kV (contact discharge)
- Complies with the standard ISO 10605: C = 330 pF, R = 330 Ω
 - ±20 kV (air discharge)
 - ±13 kV (contact discharge)
- Complies with the standard ISO 7637-3
 - Pulse 3a: VS = -150 V
 - Pulse 3b: VS = +100 V

Applications

Where ESD and EOS transient overvoltage protection in susceptible equipment is required, such as:

- Information - entertainment
- Signal communications
- Connectivity
- Comfort and convenience

Description

The **ESDA6V1-5SC6Y** is a monolithic voltage suppressor designed to protect components which are connected to data and transmission lines against ESD.

It clamps the voltage just above the logic level supply for positive transients, and to a diode drop below ground for negative transient.

Product status link

[ESDA6V1-5SC6Y](#)

Product summary

| | |
|-------------------|---------------|
| Order code | ESDA6V1-5SC6Y |
| Package | SOT23-6L |
| Packing | Tape and reel |

1 Characteristics

Table 1. Absolute ratings ($T_{amb} = 25\text{ °C}$)

| Symbol | Parameter | Value | Unit | |
|-----------|--|---|--------------------|----|
| V_{PP} | Peak pulse voltage | ISO 10605 / IEC 61000-4-2 (C = 150 pF, R = 330 Ω) | 18 | kV |
| | | Contact discharge | | |
| | Air discharge | ISO 10605 (C = 330 pF, R = 330 Ω) | 13 | |
| | | Contact discharge | | |
| | Air discharge | 20 | | |
| P_{PP} | Peak pulse power dissipation (8/20 μ s), T_j initial = T_{amb} | 80 | W | |
| I_{PP} | Peak pulse current (8/20 μ s) | 7 | A | |
| T_{sig} | Storage temperature range | -65 to +150 | $^{\circ}\text{C}$ | |
| T_j | Operating junction temperature range | -40 to +150 | $^{\circ}\text{C}$ | |
| T_L | Maximum temperature for soldering during 10 s | 260 | $^{\circ}\text{C}$ | |

Figure 1. Electrical characteristics (definitions)

| Symbol | Parameter |
|------------|----------------------------|
| V_{BR} | Breakdown voltage |
| I_{RM} | Leakage current @ V_{RM} |
| V_{RM} | Stand-off voltage |
| V_{CL} | Clamping voltage |
| I_{PP} | Peak pulse current |
| I_F | Forward current |
| V_F | Forward voltage |
| R_d | Dynamic impedance |
| C_{LINE} | Line capacitance |

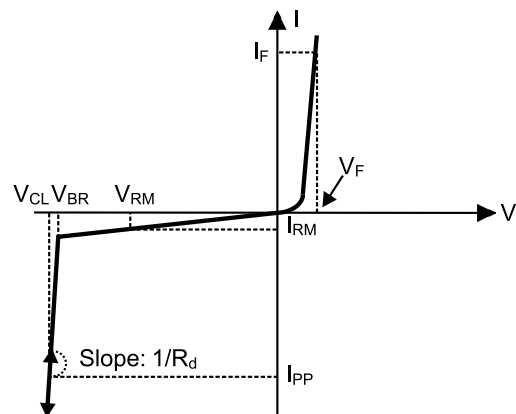
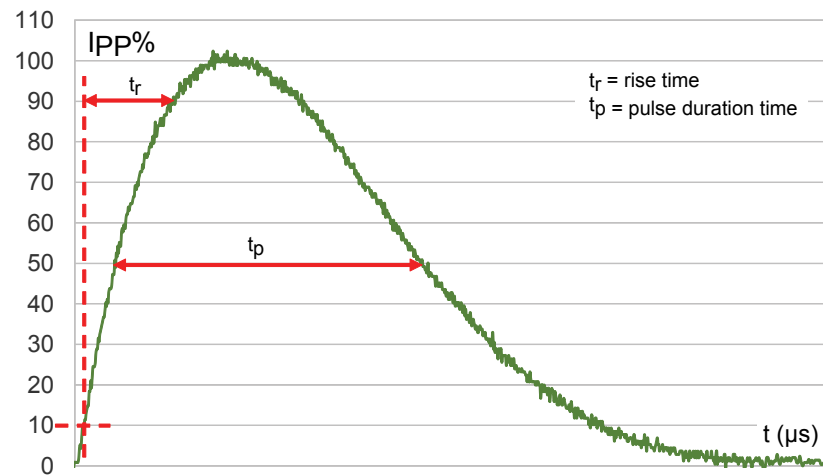

Table 2. Electrical characteristics - values ($T_{amb} = 25\text{ °C}$)

| Order code | V_{BR} at I_R | | | I_{RM} at V_{RM} | | V_{CL} at $I_{pp}^{(1)}$ | | V_F at I_F | | $\alpha T^{(2)}$ | C_{line} |
|---------------|-------------------|------|----|----------------------|-----|----------------------------|---|----------------|-----|--------------------|------------|
| | Min. | Max. | | Max. | | Max. | | Max. | | Max. | Typ. |
| | V | V | mA | μ A | V | V | A | V | mA | $10^{-4}/\text{C}$ | pF |
| ESDA6V1-5SC6Y | 6.1 | 7.2 | 1 | 1 | 5.2 | 11.4 | 7 | 1.25 | 200 | 6 | 50 |

 1. 8/20 μ s waveform

 2. V_{BR} at $T_j = V_{BR}$ at $25\text{ °C} \times (1 + \alpha T \times (T_j - 25))$

Figure 2. Pulse definition for electrical characteristics



1.1 Characteristics (curves)

Figure 3. Pulse power versus junction temperature

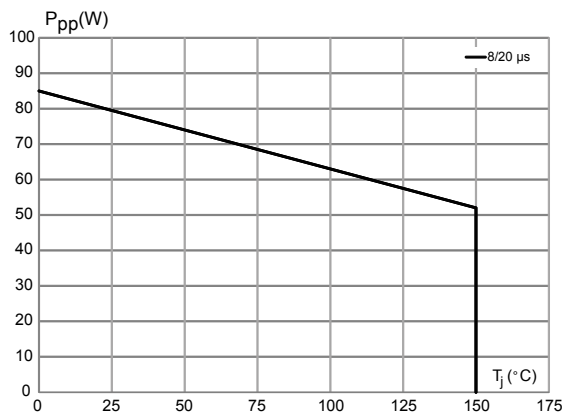

Figure 4. Peak pulse power versus exponential pulse duration

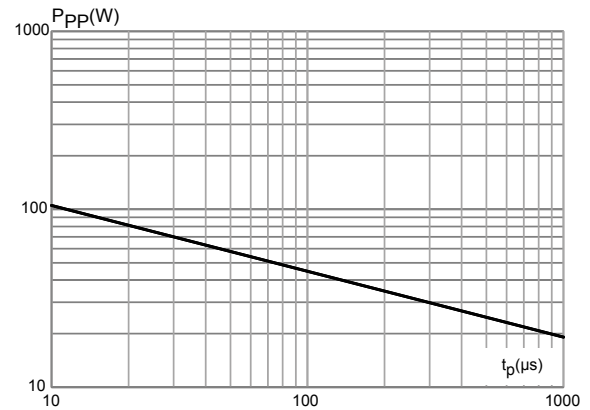

Figure 5. Clamping voltage versus peak pulse current

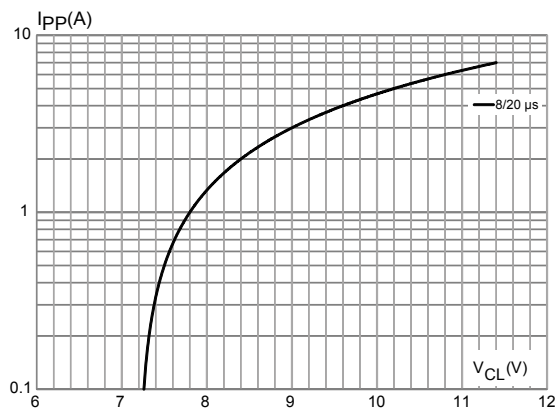

Figure 6. Leakage current versus junction temperature

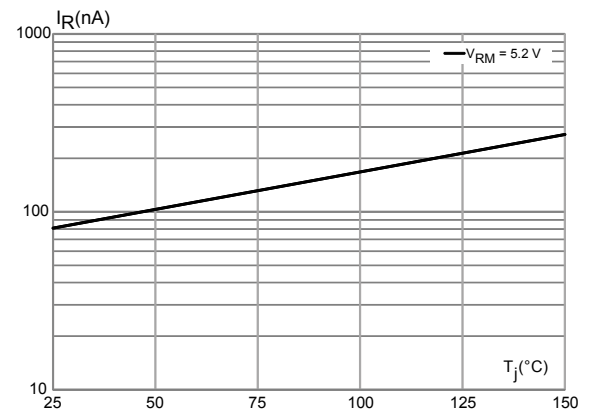
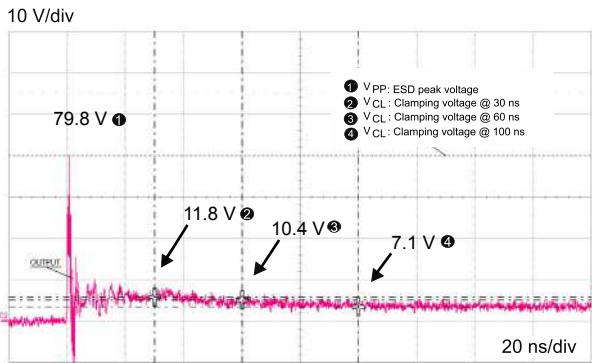
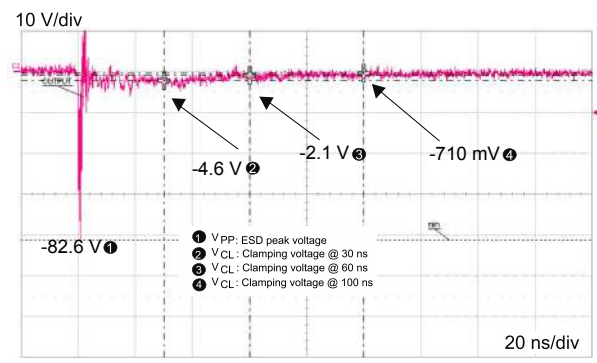
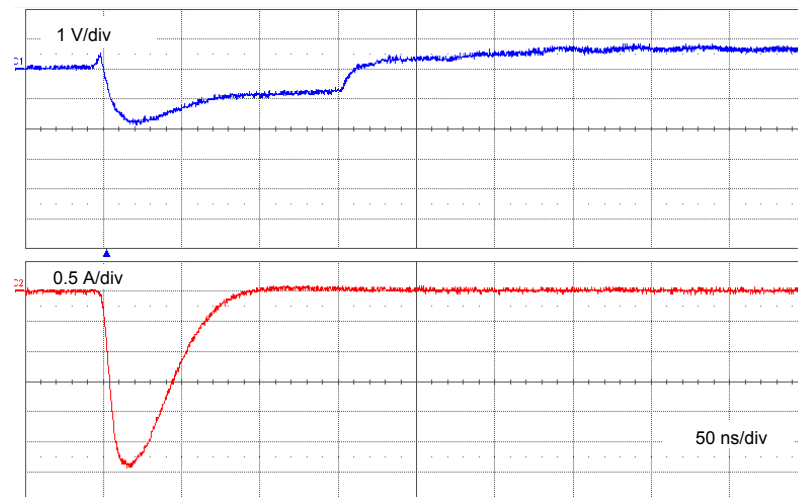
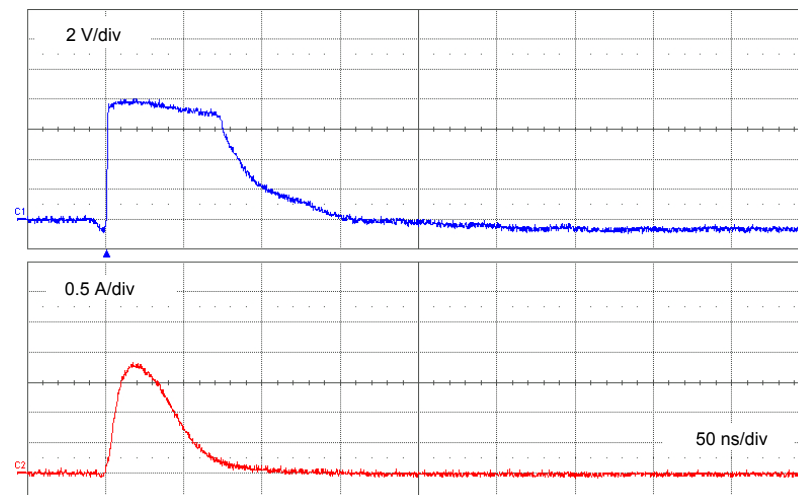

Figure 7. ESD response to IEC 61000-4-2 (+8 kV contact discharge)

Figure 8. ESD response to IEC 61000-4-2 (-8 kV contact discharge)

Figure 9. ISO7637-3 pulse 3a response ($V_S = -150$ V)

Figure 10. ISO7637-3 pulse 3b response ($V_S = 100$ V)

2 Application and design guidelines

Further information can be found in AN2689 titled: “Protection of automotive electronics from electrical hazards, guidelines for design and component selection”.

3 Package information

In order to meet environmental requirements, ST offers these devices in different grades of **ECOPACK®** packages, depending on their level of environmental compliance. ECOPACK® specifications, grade definitions and product status are available at: www.st.com. ECOPACK® is an ST trademark.

3.1 SOT23-6L package information

- Epoxy meets UL 94,V0
- Lead-free package

Figure 11. SOT23-6L package outline

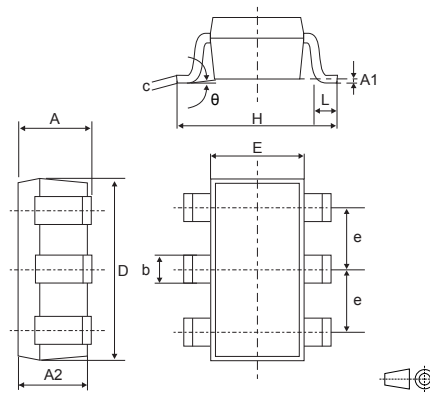

Table 3. SOT23-6L package mechanical data

| Ref. | Dimensions | | | | | |
|----------|-------------|------|------|--------|--------|--------|
| | Millimeters | | | Inches | | |
| | Min. | Typ. | Max. | Min. | Typ. | Max. |
| A | 0.9 | | 1.45 | 0.0354 | | 0.0571 |
| A1 | 0 | | 0.15 | 0 | | 0.0059 |
| A2 | 0.9 | | 1.3 | 0.0354 | | 0.0512 |
| b | 0.30 | | 0.5 | 0.0118 | | 0.0197 |
| c | 0.09 | | 0.2 | 0.0035 | | 0.0079 |
| D | 2.8 | | 3.05 | 0.1102 | | 0.1201 |
| E | 1.5 | | 1.75 | 0.0591 | | 0.0689 |
| e | | 0.95 | | | 0.0374 | |
| H | 2.6 | | 3 | 0.1024 | | 0.1181 |
| L | 0.3 | | 0.6 | 0.0118 | | 0.0236 |
| θ | 0 | | 10 | 0 | | 0.3937 |

Figure 12. Footprint recommendations, dimensions in mm (inches)

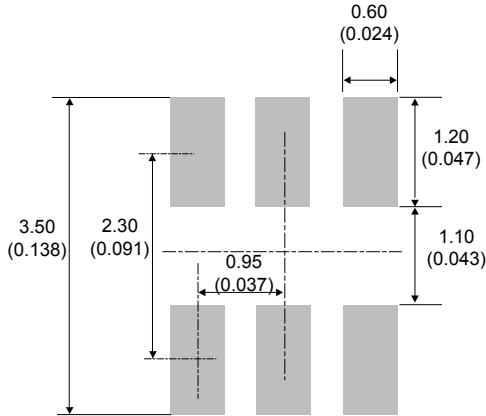

Figure 13. Marking layout (refer to ordering information table for marking)

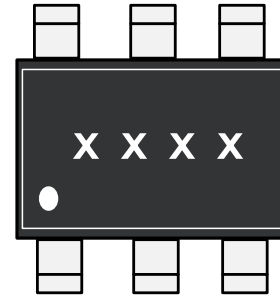
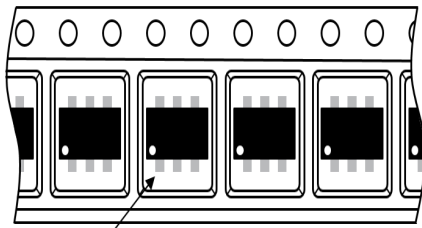

Figure 14. Package orientation in reel



Pin 1 located according to EIA-481

Note: Pocket dimensions are not on scale
Pocket shape may vary depending on package

Figure 15. Tape and reel orientation

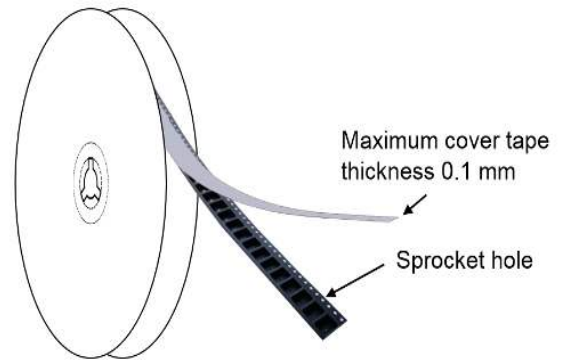

Figure 16. Reel dimensions (mm)

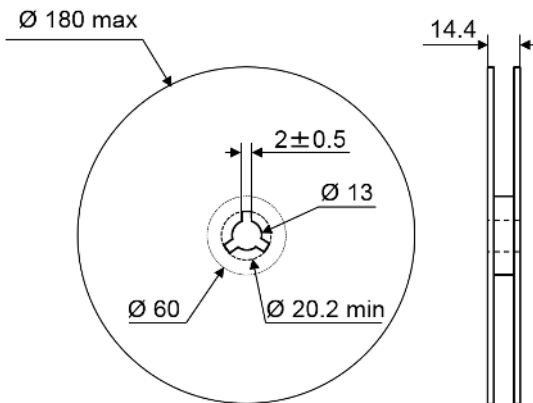

Figure 17. Inner box dimensions (mm)

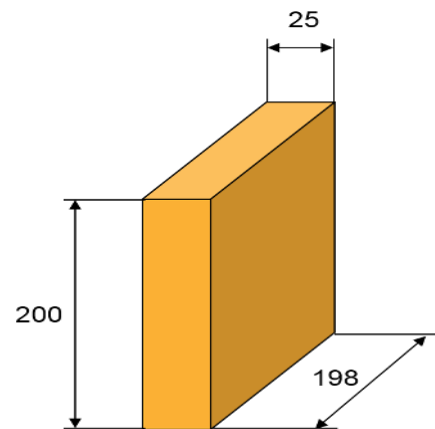
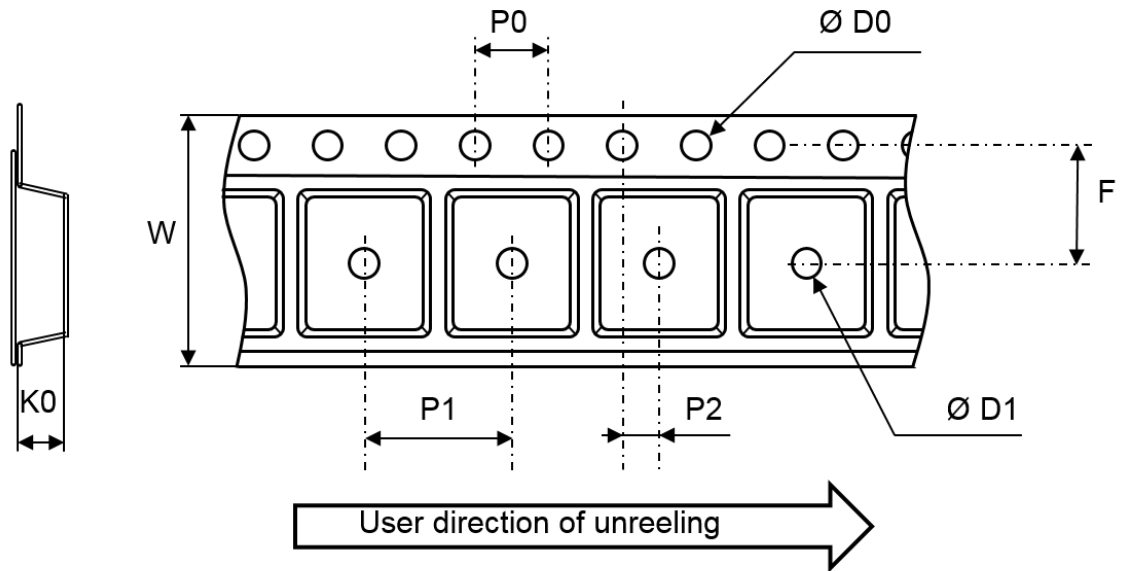

Figure 18. Tape and reel outline



Note: Pocket dimensions are not on scale
Pocket shape may vary depending on package

Table 4. Tape and reel mechanical data

| Ref. | Dimensions | | |
|------|-------------|------|------|
| | Millimeters | | |
| | Min. | Typ. | Max. |
| P1 | 3.9 | 4 | 4.1 |
| P0 | 3.9 | 4 | 4.1 |
| D0 | 1.45 | 1.5 | 1.6 |
| D1 | 1 | | |
| F | 3.45 | 3.5 | 3.55 |
| K0 | 1.3 | 1.4 | 1.6 |
| P2 | 1.95 | 2 | 2.05 |
| W | 7.9 | 8 | 8.3 |

4 Ordering information

Figure 19. Ordering information scheme

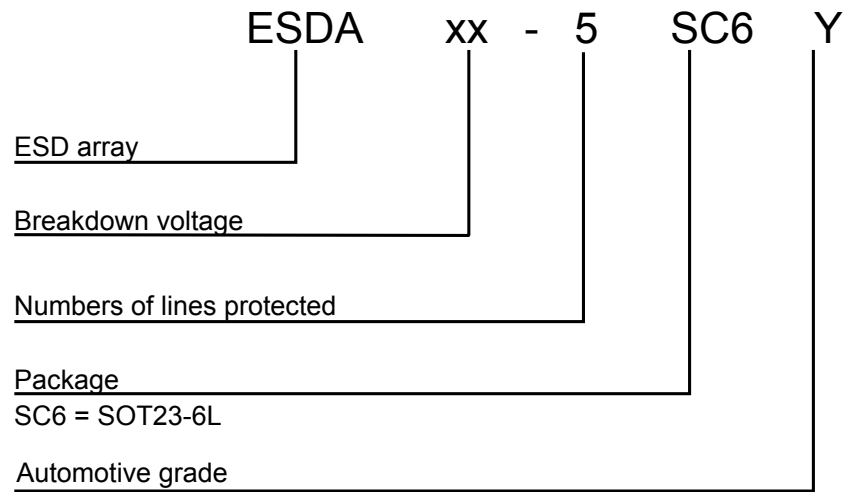

Table 5. Ordering information

| Order code | Marking | Package | Weight | Base qty. | Delivery mode |
|---------------|---------|----------|--------|-----------|---------------|
| ESDA6V1-5SC6Y | EC6Y | SOT23-6L | 14 mg | 3000 | Tape and reel |

Revision history

Table 6. Document revision history

| Date | Revision | Changes |
|-------------|----------|--|
| 08-Nov-2016 | 1 | Initial release. |
| 15-Mar-2017 | 2 | Updated title and description in cover page. Minor text changes to improve readability. |
| 03-May-2017 | 3 | Formatting improvement, no content changes. |
| 08-Jan-2019 | 4 | Updated Table 1 . |

IMPORTANT NOTICE – PLEASE READ CAREFULLY

STMicroelectronics NV and its subsidiaries (“ST”) reserve the right to make changes, corrections, enhancements, modifications, and improvements to ST products and/or to this document at any time without notice. Purchasers should obtain the latest relevant information on ST products before placing orders. ST products are sold pursuant to ST’s terms and conditions of sale in place at the time of order acknowledgement.

Purchasers are solely responsible for the choice, selection, and use of ST products and ST assumes no liability for application assistance or the design of Purchasers’ products.

No license, express or implied, to any intellectual property right is granted by ST herein.

Resale of ST products with provisions different from the information set forth herein shall void any warranty granted by ST for such product.

ST and the ST logo are trademarks of ST. All other product or service names are the property of their respective owners.

Information in this document supersedes and replaces information previously supplied in any prior versions of this document.

© 2019 STMicroelectronics – All rights reserved