

EVALUATION KIT  
AVAILABLE

MAXIM

## 2.3W, Ultra-Low-EMI, Filterless, Class D Audio Amplifier

MAX9705

### General Description

The MAX9705 3rd-generation, ultra-low EMI, mono, Class D audio power amplifier provides Class AB performance with Class D efficiency. The MAX9705 delivers 2.3W into a 4Ω load and offers efficiencies above 85%. Active emissions limiting (AEL) circuitry greatly reduces EMI by actively controlling the output FET gate transitions under all possible transient output-voltage conditions. AEL prevents high-frequency emissions resulting from conventional Class D free-wheeling behavior in the presence of an inductive load. Zero dead time (ZDT) technology maintains state-of-the-art efficiency and THD+N performance by allowing the output FETs to switch simultaneously without cross-conduction. A patented spread-spectrum modulation scheme eliminates the need for output filtering found in traditional Class D devices. These design concepts reduce an application's component count and extend battery life.

The MAX9705 offers two modulation schemes: a fixed-frequency (FFM) mode and a spread-spectrum (SSM) mode that further reduces EMI-radiated emissions due to the modulation frequency. The MAX9705 oscillator can be synchronized to an external clock through the SYNC input, allowing the switching frequency to be externally defined. The SYNC input also allows multiple MAX9705s to be cascaded and frequency locked, minimizing interference due to clock intermodulation. The device utilizes a fully differential architecture, a full-bridged output, and comprehensive click-and-pop suppression. The gain of the MAX9705 is set internally (MAX9705A: 6dB, MAX9705B: 12dB, MAX9705C: 15.6dB, MAX9705D: 20dB), further reducing external component count.

The MAX9705 is available in 10-pin TDFN (3mm x 3mm x 0.8mm), and 12-bump UCSP™ (1.5mm x 2mm x 0.6mm) packages. The MAX9705 is specified over the extended -40°C to +85°C temperature range.

### Applications

Cellular Phones  
PDAsMP3 Players  
Portable Audio

Selector Guide appears at end of data sheet.

UCSP is a trademark of Maxim Integrated Products, Inc.

### Features

- ◆ Filterless Amplifier Passes FCC-Radiated Emissions Standards with 24in of Cable
- ◆ Unique Spread-Spectrum Mode and Active Emissions Limiting (AEL) Achieves Better than 20dB Margin Under FCC Limits
- ◆ Zero Dead Time (ZDT) H-Bridge Maintains State-of-the-Art Efficiency and THD+N
- ◆ Simple Master-Slave Setup for Stereo Operation
- ◆ Up to 90% Efficiency
- ◆ 2.3W into 4Ω (1% THD+N)
- ◆ Low 0.02% THD+N (POUT = 1W, VDD = 5.0V)
- ◆ High PSRR (75dB at 217Hz)
- ◆ Integrated Click-and-Pop Suppression
- ◆ Low Quiescent Current (5.4mA)
- ◆ Low-Power Shutdown Mode (0.3μA)
- ◆ Short-Circuit and Thermal-Overload Protection
- ◆ Available in Thermally Efficient, Space-Saving Packages
  - 10-Pin TDFN (3mm x 3mm x 0.8mm)
  - 12-Bump UCSP (1.5mm x 2mm x 0.6mm)
- ◆ Pin-for-Pin Compatible with the MAX9700 and MAX9712

### Ordering Information

| PART          | TEMP RANGE     | PIN-PACKAGE | TOP MARK |
|---------------|----------------|-------------|----------|
| MAX9705AETB+T | -40°C to +85°C | 10 TDFN     | ACY      |
| MAX9705AEBC+T | -40°C to +85°C | 12 UCSP     | ACH      |
| MAX9705BETB+T | -40°C to +85°C | 10 TDFN     | ACX      |
| MAX9705BEBC+T | -40°C to +85°C | 12 UCSP     | ACG      |

Ordering Information continued at end of data sheet.

+Denotes a lead-free/RoHS-compliant package.

T = Tape and reel.

### EMI Spectrum Diagram

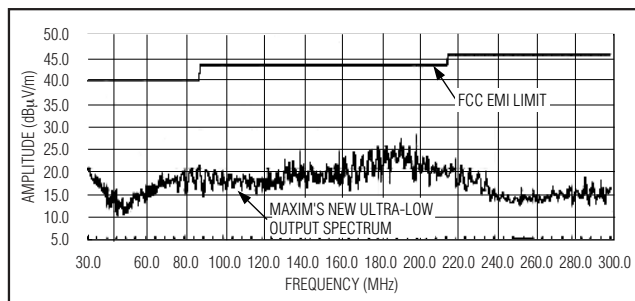

MAXIM

Maxim Integrated Products 1

For pricing, delivery, and ordering information, please contact Maxim Direct at 1-888-629-4642, or visit Maxim's website at [www.maxim-ic.com](http://www.maxim-ic.com).

# 2.3W, Ultra-Low-EMI, Filterless, Class D Audio Amplifier

## ABSOLUTE MAXIMUM RATINGS

|   |  |   |                      |
|---|--|---|----------------------|
| V <sub>DD</sub> to GND  | .....6V                                | Continuous Power Dissipation (T <sub>A</sub> = +70°C) |                      |
| PV <sub>DD</sub> to PGND  | .....6V                                | 10-Pin TDFN (derate 24.4mW/°C above +70°C)            | .....1951.2mW        |
| GND to PGND   | .....-0.3V to +0.3V                    | 12-Bump UCSP (derate 6.1mW/°C above +70°C)            | .....484mW           |
| PV <sub>DD</sub> to V <sub>DD</sub>                                     | .....-0.3V to +0.3V                    | Junction Temperature                                  | .....+150°C          |
| All Other Pins to GND   | .....-0.3V to (V <sub>DD</sub> + 0.3V) | Operating Temperature Range                           | .....-40°C to +85°C  |
| Continuous Current Into/Out of PV <sub>DD</sub> /PGND/OUT <sub>-</sub>  | .....±600mA                            | Storage Temperature Range                             | .....-65°C to +150°C |
| Continuous Input Current (all other pins)                               | .....±20mA                             | Lead Temperature (soldering, 10s)                     | .....+300°C          |
| Duration of OUT <sub>-</sub> Short Circuit to GND or PV <sub>DD</sub>   | .....Continuous                        | Bump Temperature (soldering)                          |                      |
| Duration of Short Circuit Between OUT <sub>+</sub> and OUT <sub>-</sub> | .....Continuous                        | Reflow  | .....+235°C          |

Stresses beyond those listed under "Absolute Maximum Ratings" may cause permanent damage to the device. These are stress ratings only, and functional operation of the device at these or any other conditions beyond those indicated in the operational sections of the specifications is not implied. Exposure to absolute maximum rating conditions for extended periods may affect device reliability.

## ELECTRICAL CHARACTERISTICS

(V<sub>DD</sub> = PV<sub>DD</sub> = V<sub>SHDN</sub> = 3.3V, V<sub>GND</sub> = V<sub>PGND</sub> = 0V, SYNC = GND (FFM), R<sub>L</sub> = ∞, R<sub>L</sub> connected between OUT<sub>+</sub> and OUT<sub>-</sub>, T<sub>A</sub> = T<sub>MIN</sub> to T<sub>MAX</sub>, unless otherwise noted. Typical values are at T<sub>A</sub> = +25°C.) (Notes 1, 2)

| PARAMETER                             | SYMBOL            | CONDITIONS   | MIN   | TYP  | MAX   | UNITS |   |
|---------------------------------------|-------------------|--|---|------|-------|-------|---|
| <b>GENERAL</b>                        |                   |  |   |      |       |       |   |
| Supply Voltage Range                  | V <sub>DD</sub>   | Inferred from PSRR test                                | 2.5   |      | 5.5   | V     |   |
| Quiescent Current                     | I <sub>DD</sub>   |  |   | 5.4  | 7     | mA    |   |
| Shutdown Current                      | I <sub>SHDN</sub> |  |   | 0.3  | 10    | μA    |   |
| Turn-On Time                          | t <sub>ON</sub>   |  |   | 30   |       | ms    |   |
| Input Resistance                      | R <sub>IN</sub>   | T <sub>A</sub> = +25°C                                 | 12  | 20   |       | kΩ    |   |
| Input Bias Voltage                    | V <sub>BIAS</sub> | Either input   | MAX9705A  | 0.88 | 1.0   | 1.12  | V |
|                                       |                   |  | MAX9705B  | 0.73 | 0.83  | 0.93  |   |
|                                       |                   |  | MAX9705C  | 0.61 | 0.71  | 0.81  |   |
|                                       |                   |  | MAX9705D  | 0.48 | 0.56  | 0.64  |   |
| Voltage Gain                          | A <sub>V</sub>    | MAX9705A   | 1.9   | 2.0  | 2.1   | V/V   |   |
|                                       |                   | MAX9705B   | 3.8   | 4.0  | 4.2   |       |   |
|                                       |                   | MAX9705C   | 5.7   | 6.0  | 6.3   |       |   |
|                                       |                   | MAX9705D   | 9.5   | 10   | 10.5  |       |   |
| Output Offset Voltage                 | V <sub>OS</sub>   | T <sub>A</sub> = +25°C                                 |   | ±10  | ±69   | mV    |   |
| Common-Mode Rejection Ratio           | CMRR              | f <sub>IN</sub> = 1kHz, input referred                 |   | 56   |       | dB    |   |
| Power-Supply Rejection Ratio (Note 3) | PSRR              | V <sub>DD</sub> = 2.5V to 5.5V, T <sub>A</sub> = +25°C | 50  | 75   |       | dB    |   |
|                                       |                   | 200mV <sub>P-P</sub> ripple                            | f <sub>RIPPLE</sub> = 217Hz                                   |      | 75    |       |   |
|                                       |                   |  | f <sub>RIPPLE</sub> = 20kHz                                   |      | 60    |       |   |
| Output Power                          | P <sub>OUT</sub>  | THD+N = 1%,<br>f <sub>IN</sub> = 1kHz                  | R <sub>L</sub> = 8Ω   |      | 600   | mW    |   |
|                                       |                   |  | R <sub>L</sub> = 4Ω<br>MAX9705_ETB+T and<br>MAX9705_EUB+ only |      | 950   |       |   |
| Total Harmonic Distortion Plus Noise  | THD+N             | f <sub>IN</sub> = 1kHz, either<br>FFM or SSM           | R <sub>L</sub> = 8Ω,<br>P <sub>OUT</sub> = 450mW              |      | 0.02  | %     |   |
|                                       |                   |  | R <sub>L</sub> = 4Ω,<br>P <sub>OUT</sub> = 375mW              |      | 0.025 |       |   |
| Click/Pop Level                       | K <sub>CP</sub>   | Peak voltage,<br>A-weighted<br>(Notes 3, 4)            | Into shutdown   |      | -68   | dB    |   |
|                                       |                   |  | Out of shutdown   |      | -60.5 |       |   |
| Output Slew Rate                      | SR                |  |   | 176  |       | V/μs  |   |

# 2.3W, Ultra-Low-EMI, Filterless, Class D Audio Amplifier

MAX9705

## ELECTRICAL CHARACTERISTICS (continued)

( $V_{DD} = P_{VDD} = \overline{V_{SHDN}} = 3.3V$ ,  $V_{GND} = V_{PGND} = 0V$ ,  $SYNC = GND$  (FFM),  $R_L = \infty$ ,  $R_L$  connected between  $OUT+$  and  $OUT-$ ,  $T_A = T_{MIN}$  to  $T_{MAX}$ , unless otherwise noted. Typical values are at  $T_A = +25^\circ C$ .) (Notes 1, 2)

| PARAMETER  | SYMBOL               | CONDITIONS  |                    | MIN  | TYP               | MAX      | UNITS   |
|--|----------------------|---|--------------------|------|-------------------|----------|---------|
| Rise/Fall Time   | $t_{RISE}, t_{FALL}$ | 10% to 90%  |                    |      | 15                |          | ns      |
| Signal-to-Noise Ratio                                      | SNR                  | $V_{OUT} = 2V_{RMS}$                                  | BW = 22Hz to 22kHz | FFM  | 91                |          | dB      |
|  |                      |   |                    | SSM  | 89                |          |         |
|  |                      |   | A-weighted         | FFM  | 93                |          |         |
|  |                      |   |                    | SSM  | 91                |          |         |
| Oscillator Frequency                                       | $f_{OSC}$            | SYNC = GND  |                    | 980  | 1100              | 1220     | kHz     |
|  |                      | SYNC = unconnected                                    |                    | 1250 | 1450              | 1650     |         |
|  |                      | SYNC = $V_{DD}$ (SSM mode)                            |                    |      | 1220<br>$\pm 120$ |          |         |
| SYNC Frequency Lock Range                                  |                      |   |                    | 800  |                   | 2000     | kHz     |
| Efficiency   | $\eta$               | $P_{OUT} = 800mW$ , $f_{IN} = 1kHz$ , $R_L = 8\Omega$ |                    |      | 89                |          | %       |
| <b>DIGITAL INPUTS (<math>\overline{SHDN}</math>, SYNC)</b> |                      |   |                    |      |                   |          |         |
| Input Thresholds   |                      | $V_{IH}$  |                    | 2    |                   |          | V       |
|  |                      | $V_{IL}$  |                    |      |                   | 0.8      |         |
| $\overline{SHDN}$ Input Leakage Current                    |                      |   |                    |      | 0.1               | $\pm 10$ | $\mu A$ |
| SYNC Input Current   |                      | (Note 5)  |                    |      | -1.25             | $\pm 10$ | $\mu A$ |

## ELECTRICAL CHARACTERISTICS

( $V_{DD} = P_{VDD} = \overline{V_{SHDN}} = 5V$ ,  $V_{GND} = V_{PGND} = 0V$ ,  $SYNC = GND$  (FFM),  $R_L = \infty$ ,  $R_L$  connected between  $OUT+$  and  $OUT-$ ,  $T_A = T_{MIN}$  to  $T_{MAX}$ , unless otherwise noted. Typical values are at  $T_A = +25^\circ C$ .) (Notes 1, 2)

| PARAMETER                            | SYMBOL     | CONDITIONS                     |   | MIN | TYP  | MAX | UNITS   |
|--------------------------------------|------------|--------------------------------|---|-----|------|-----|---------|
| Quiescent Current                    | $I_{DD}$   |                                |   |     | 7    |     | mA      |
| Shutdown Current                     | $I_{SHDN}$ |                                |   |     | 0.55 |     | $\mu A$ |
| Power-Supply Rejection Ratio         | PSRR       | 200mV <sub>P-P</sub> ripple    | f = 217Hz   |     | 75   |     | dB      |
|                                      |            |                                | f = 20kHz   |     | 60   |     |         |
| Output Power                         | $P_{OUT}$  | THD+N = 1%,<br>f = 1kHz        | $R_L = 16\Omega$  |     | 750  |     | mW      |
|                                      |            |                                | $R_L = 8\Omega$   |     | 1400 |     |         |
|                                      |            |                                | $R_L = 4\Omega$<br>MAX9705_ETB+T and<br>MAX9705_EUB+ only |     | 2300 |     |         |
| Total Harmonic Distortion Plus Noise | THD+N      | f = 1kHz, either<br>FFM or SSM | $R_L = 8\Omega$ , $P_{OUT} = 1.0W$                        |     | 0.02 |     | %       |
|                                      |            |                                | $R_L = 4\Omega$ , $P_{OUT} = 1.75W$                       |     | 0.05 |     |         |
| Signal-to-Noise Ratio                | SNR        | $V_{OUT} = 3V_{RMS}$           | BW = 22Hz to 22kHz  | FFM | 94   |     | dB      |
|                                      |            |                                |   | SSM | 91   |     |         |
|                                      |            |                                | A-weighted  | FFM | 97   |     |         |
|                                      |            |                                |   | SSM | 93   |     |         |

**Note 1:** All devices are 100% production tested at  $+25^\circ C$ . All temperature limits are guaranteed by design.

**Note 2:** Testing performed with a resistive load in series with an inductor to simulate an actual speaker load. For  $R_L = 4\Omega$ ,  $L = 33\mu H$ . For  $R_L = 8\Omega$ ,  $L = 68\mu H$ . For  $R_L = 16\Omega$ ,  $L = 136\mu H$ .

**Note 3:** Inputs AC-coupled to GND.

**Note 4:** Testing performed with  $8\Omega$  resistive load in series with  $68\mu H$  inductive load connected across BTL output. Mode transitions are controlled by  $\overline{SHDN}$  pin.  $K_{CP}$  level is calculated as  $20 \times \log[(\text{peak voltage under normal operation at rated power level})/(\text{peak voltage during mode transition, no input signal})]$ . Units are expressed in dB.

**Note 5:** SYNC has a  $1M\Omega$  resistor to  $V_{REF} = 1.25V$ .

# 2.3W, Ultra-Low-EMI, Filterless, Class D Audio Amplifier

## Typical Operating Characteristics

( $V_{DD} = 3.3V$ ,  $SYNC = V_{DD}$  (SSM), differential input,  $T_A = +25^\circ C$ , unless otherwise noted. Typical Operating Characteristics for  $4\Omega$  load condition apply to the MAX9705\_ETB+T only.)

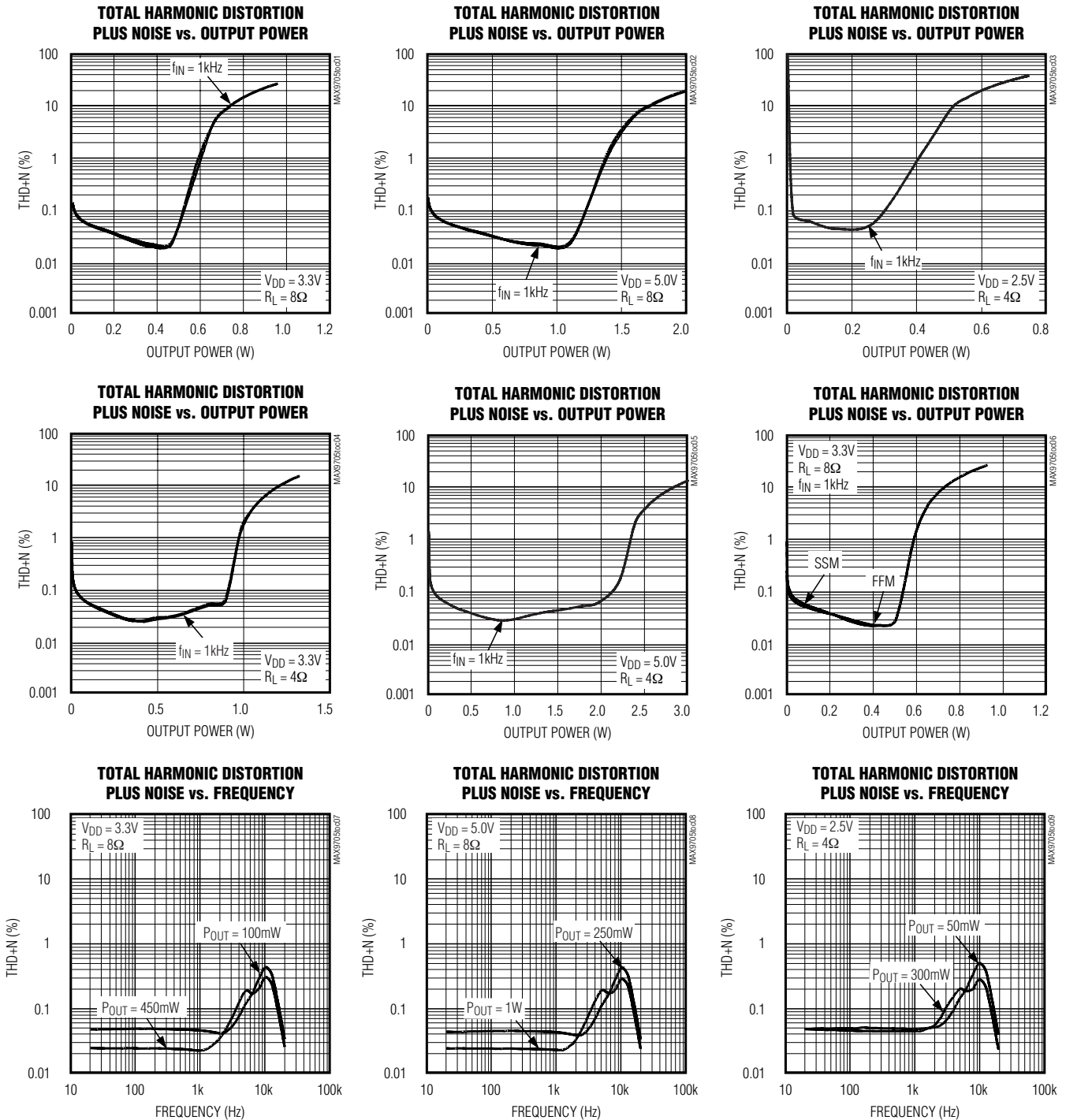

# 2.3W, Ultra-Low-EMI, Filterless, Class D Audio Amplifier

MAX9705

## Typical Operating Characteristics (continued)

( $V_{DD} = 3.3V$ ,  $SYNC = V_{DD}$  (SSM), differential input,  $T_A = +25^\circ C$ , unless otherwise noted. Typical Operating Characteristics for  $4\Omega$  load condition apply to the MAX9705\_ETB+T only.)

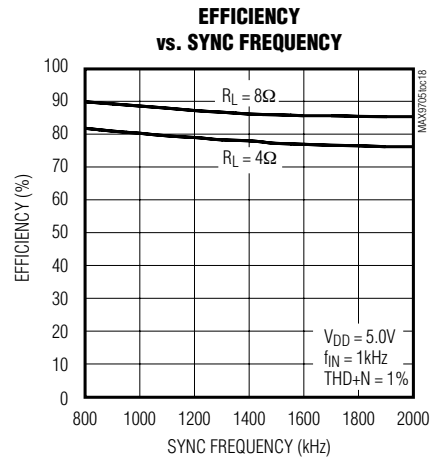
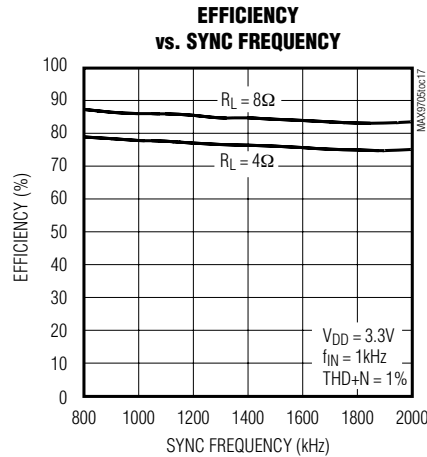
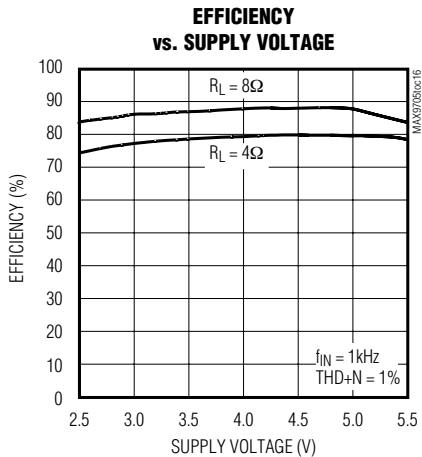
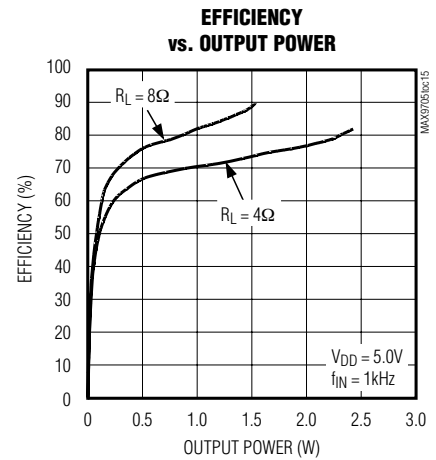
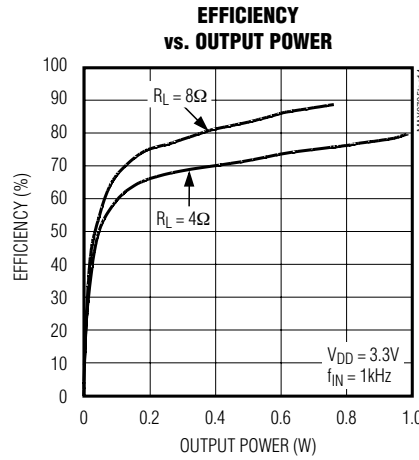
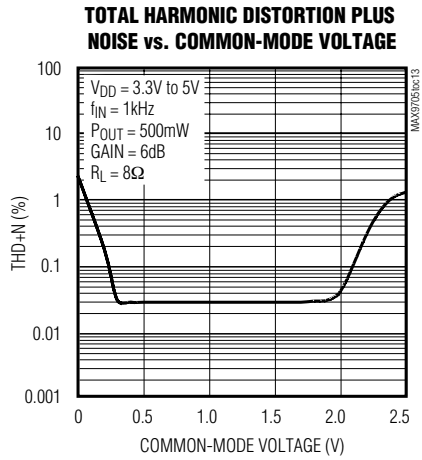
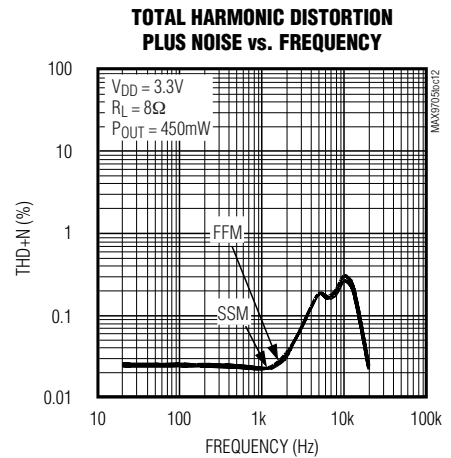
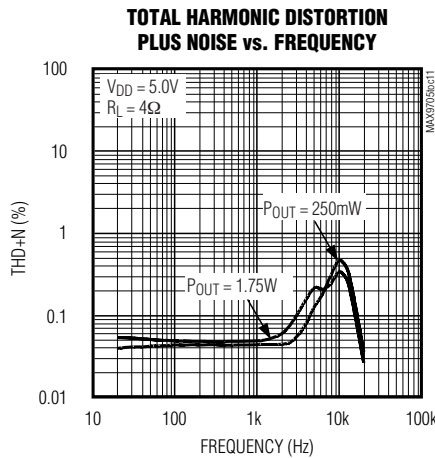
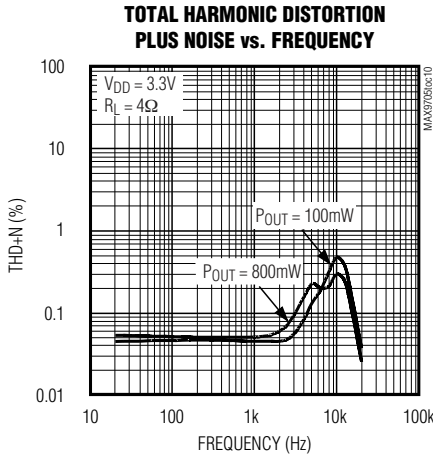

# 2.3W, Ultra-Low-EMI, Filterless, Class D Audio Amplifier

## Typical Operating Characteristics (continued)

( $V_{DD} = 3.3V$ ,  $SYNC = V_{DD}$  (SSM), differential input,  $T_A = +25^\circ C$ , unless otherwise noted. Typical Operating Characteristics for  $4\Omega$  load condition apply to the MAX9705\_ETB+T only.)

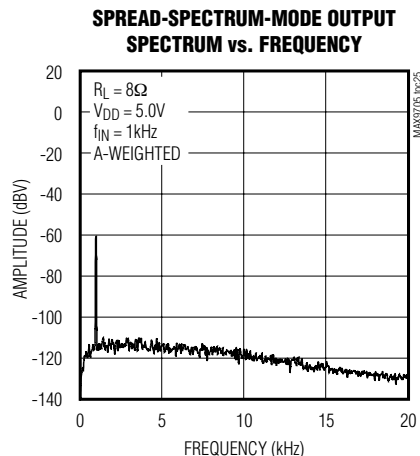
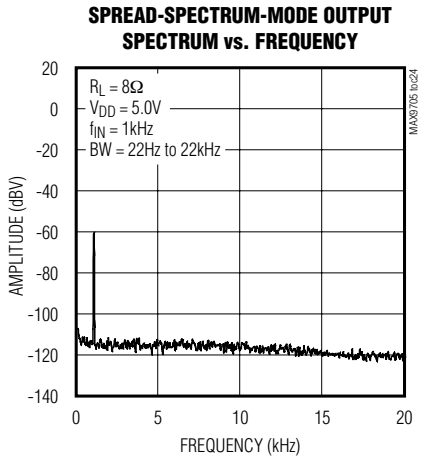
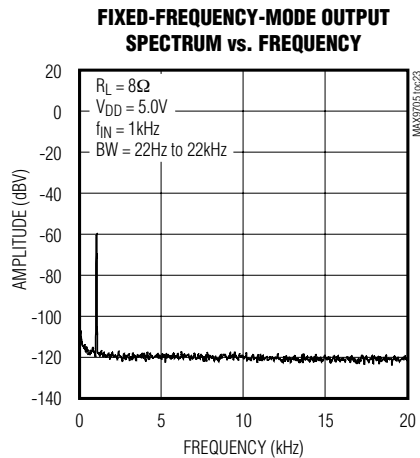
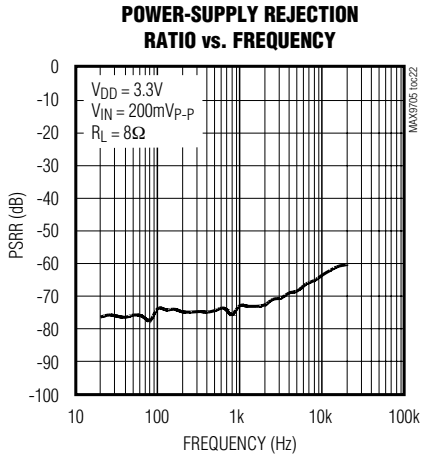
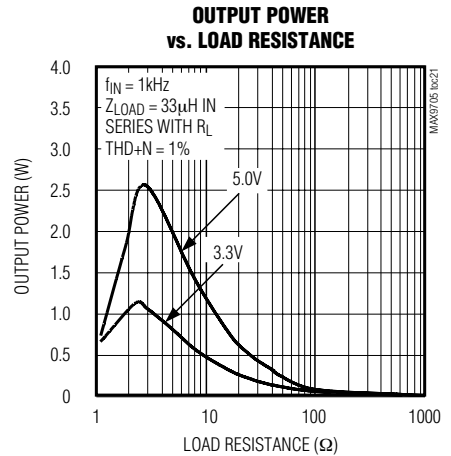
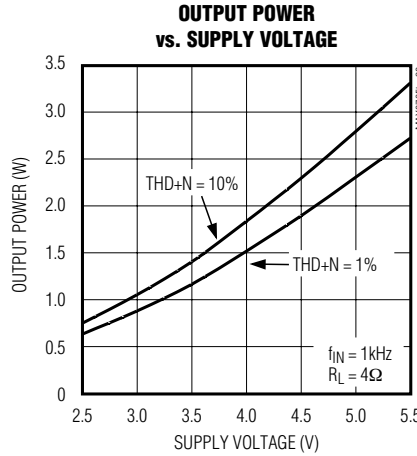
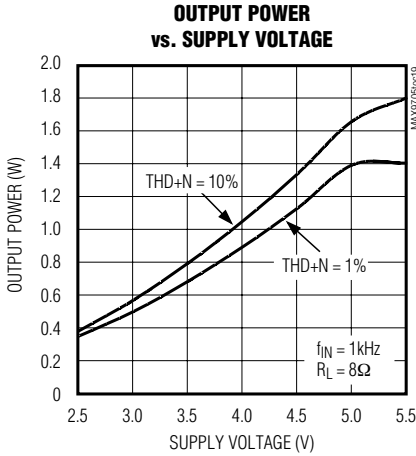

# 2.3W, Ultra-Low-EMI, Filterless, Class D Audio Amplifier

MAX9705

## Typical Operating Characteristics (continued)

( $V_{DD} = 3.3V$ ,  $SYNC = V_{DD}$  (SSM), differential input,  $T_A = +25^\circ C$ , unless otherwise noted. Typical Operating Characteristics for  $4\Omega$  load condition apply to the MAX9705\_ETB+T only.)

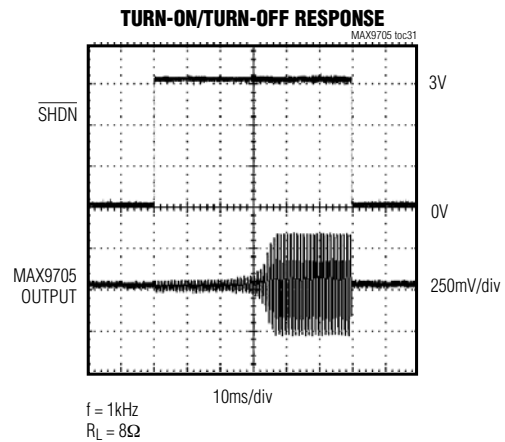
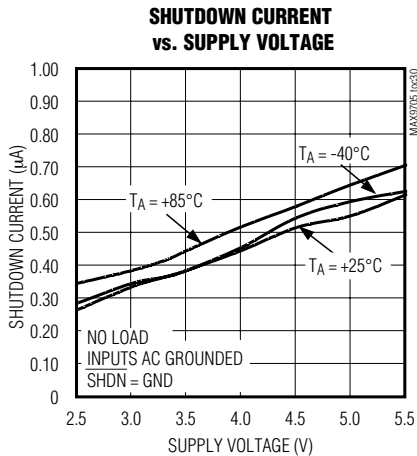
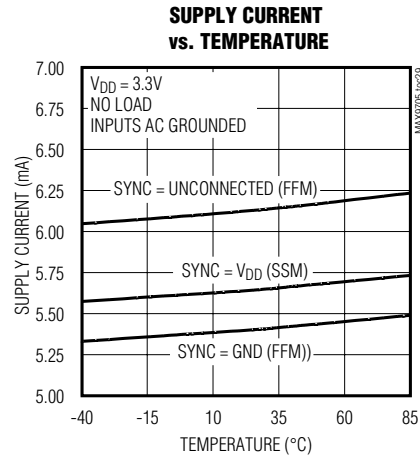
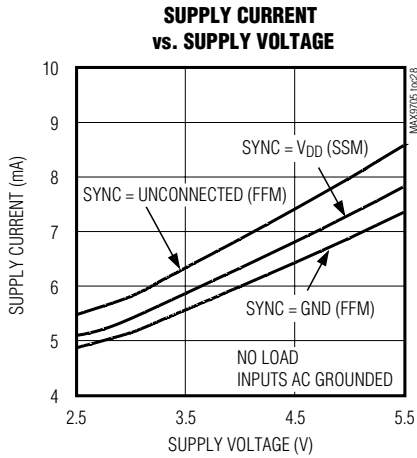
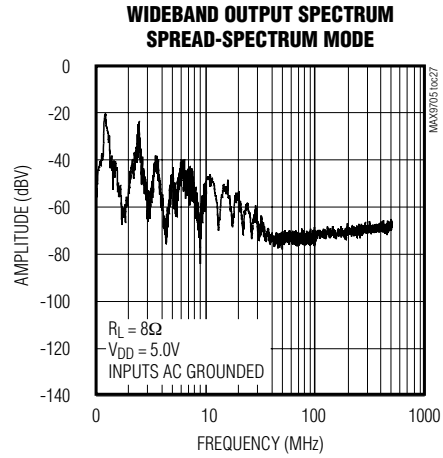
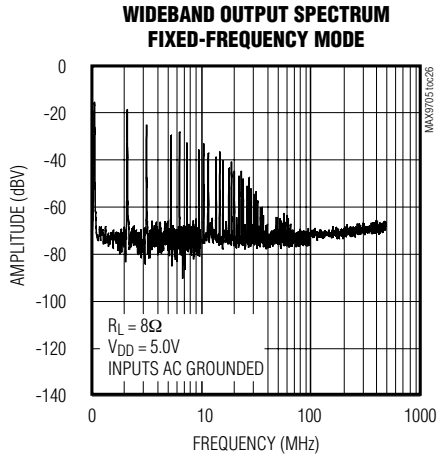

# 2.3W, Ultra-Low-EMI, Filterless, Class D Audio Amplifier

## Functional Diagram

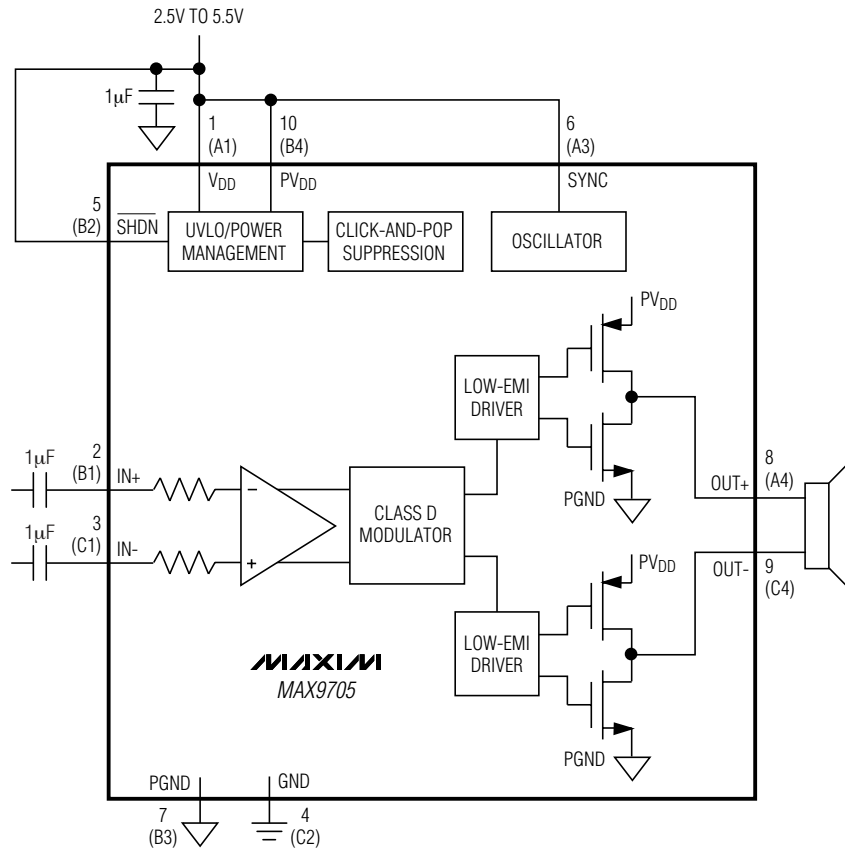

( ) UCSP BUMP.  
 FIGURE SHOWS MAX9705 CONFIGURED FOR SPREAD-SPECTRUM OPERATION.



# 2.3W, Ultra-Low-EMI, Filterless, Class D Audio Amplifier

## Pin Description

MAX9705

| PIN  | BUMP | NAME             | FUNCTION   |
|------|------|------------------|--|
| TDFN | UCSP |                  |  |
| 1    | A1   | V <sub>DD</sub>  | Analog Power Supply  |
| 2    | B1   | IN+              | Noninverting Audio Input   |
| 3    | C1   | IN-              | Inverting Audio Input  |
| 4    | C2   | GND              | Analog Ground  |
| 5    | B2   | SHDN             | Active-Low Shutdown Input. Connect to V <sub>DD</sub> for normal operation.  |
| 6    | A3   | SYNC             | Frequency Select and External Clock Input.<br><b>SYNC = GND:</b> Fixed-frequency mode with f <sub>S</sub> = 1100kHz.<br><b>SYNC = Unconnected:</b> Fixed-frequency mode with f <sub>S</sub> = 1450kHz.<br><b>SYNC = V<sub>DD</sub>:</b> Spread-spectrum mode with f <sub>S</sub> = 1220kHz ±120kHz.<br><b>SYNC = Clocked:</b> Fixed-frequency mode with f <sub>S</sub> = external clock frequency. |
| 7    | B3   | PGND             | Power Ground   |
| 8    | A4   | OUT+             | Amplifier-Output Positive Phase  |
| 9    | C4   | OUT-             | Amplifier-Output Negative Phase  |
| 10   | B4   | PV <sub>DD</sub> | H-Bridge Power Supply  |
| —    | —    | EP               | Exposed Pad. Internally connected to ground. Connect to a large ground plane to maximize thermal performance. Not intended as an electrical connection point (TDFN only).  |

### Detailed Description

The MAX9705 ultra-low-EMI, filterless, Class D audio power amplifier features several improvements to switch-mode amplifier technology. The MAX9705 features output driver active emissions limiting circuitry to reduce EMI. Zero dead time technology maintains state-of-the-art efficiency and THD+N performance by allowing the output FETs to switch simultaneously without cross-conduction. A unique filterless modulation scheme, synchronizable switching frequency, and spread-spectrum mode create a compact, flexible, low-noise, efficient audio power amplifier while occupying minimal board space. The differential input architecture reduces common-mode noise pickup with or without the use of input-coupling capacitors. The MAX9705 can also be configured as a single-ended input amplifier without performance degradation.

Thermal-overload and short-circuit protection prevent the MAX9705 from being damaged during a fault condition. The amplifier is disabled if the die temperature reaches +125°C. The die must cool by 10°C before normal operation can continue. The output of the MAX9705 shuts down if the output current reaches approximately 2A. Each output FET has its own short-circuit protection. This protection scheme allows the amplifier to survive shorts to either supply rail. After a thermal overload or short circuit, the device remains disabled for a minimum of 50μs before attempting to return to normal operation. The amplifier will

shut down immediately and wait another 50μs before turning on if the fault condition is still present. This operation will cause the output to pulse during a persistent fault.

Comparators monitor the MAX9705 inputs and compare the complementary input voltages to the sawtooth waveform. The comparators trip when the input magnitude of the sawtooth exceeds their corresponding input voltage. Both comparators reset at a fixed time after the rising edge of the second comparator trip point, generating a minimum-width pulse t<sub>ON(MIN)</sub> at the output of the second comparator (Figure 1). As the input voltage increases or decreases, the duration of the pulse at one output increases (the first comparator to trip), while the other output pulse duration remains at t<sub>ON(MIN)</sub>. This causes the net voltage across the speaker (V<sub>OUT+</sub> - V<sub>OUT-</sub>) to change.

### Operating Modes

#### Fixed-Frequency Modulation (FFM) Mode

The MAX9705 features two FFM modes. The FFM modes are selected by setting SYNC = GND for a 1.1MHz switching frequency, and SYNC = unconnected for a 1.45MHz switching frequency. In FFM mode, the frequency spectrum of the Class D output consists of the fundamental switching frequency and its associated harmonics (see the Wideband Output Spectrum Fixed-Frequency Mode graph in the *Typical Operating*

## 2.3W, Ultra-Low-EMI, Filterless, Class D Audio Amplifier

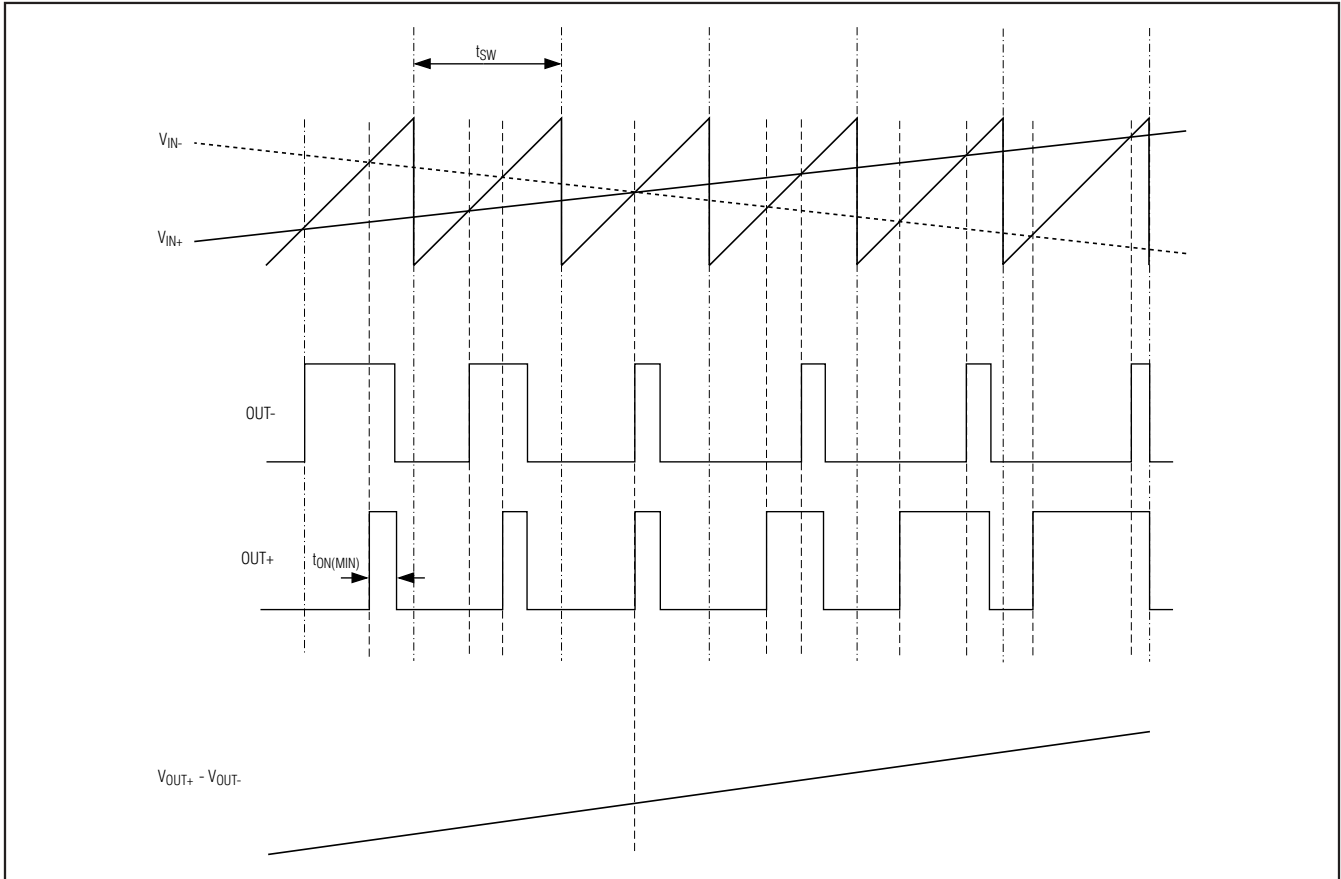

Figure 1. MAX9705 Outputs with an Input Signal Applied

**Table 1. Operating Modes**

| SYNC INPUT  | MODE  |
|-------------|---|
| GND         | FFM with $f_S = 1100\text{kHz}$                   |
| Unconnected | FFM with $f_S = 1450\text{kHz}$                   |
| $V_{DD}$    | SSM with $f_S = 1220\text{kHz} \pm 120\text{kHz}$ |
| Clocked     | FFM with $f_S = \text{external clock frequency}$  |

*Characteristics*). The MAX9705 allows the switching frequency to be changed by +32%, should the frequency of one or more of the harmonics fall in a sensitive band. This can be done at any time and does not affect audio reproduction.

### Spread-Spectrum Modulation (SSM) Mode

The MAX9705 features a unique, patented spread-spectrum mode that flattens the wideband spectral components, improving EMI emissions by 5dB. Proprietary techniques ensure that the cycle-to-cycle variation of the switching period does not degrade audio reproduction or efficiency

(see the *Typical Operating Characteristics*). Select SSM mode by setting  $\text{SYNC} = V_{DD}$ . In SSM mode, the switching frequency varies randomly by  $\pm 120\text{kHz}$  around the center frequency (1.22MHz). The modulation scheme remains the same, but the period of the sawtooth waveform changes from cycle to cycle (Figure 2). Instead of a large amount of spectral energy present at multiples of the switching frequency, the energy is now spread over a bandwidth that increases with frequency. Above a few megahertz, the wideband spectrum looks like white noise for EMI purposes (see the *EMI Spectrum Diagram*).

### External Clock Mode

The SYNC input allows the MAX9705 to be synchronized to a system clock moving the spectral components of the switching harmonics to insensitive frequency bands. Applying an external TTL clock of 800kHz to 2MHz to SYNC synchronizes the switching frequency of the MAX9705. The period of the SYNC clock can be randomized, enabling the MAX9705 to be synchronized to another MAX9705 operating in SSM mode.

## 2.3W, Ultra-Low-EMI, Filterless, Class D Audio Amplifier

MAX9705

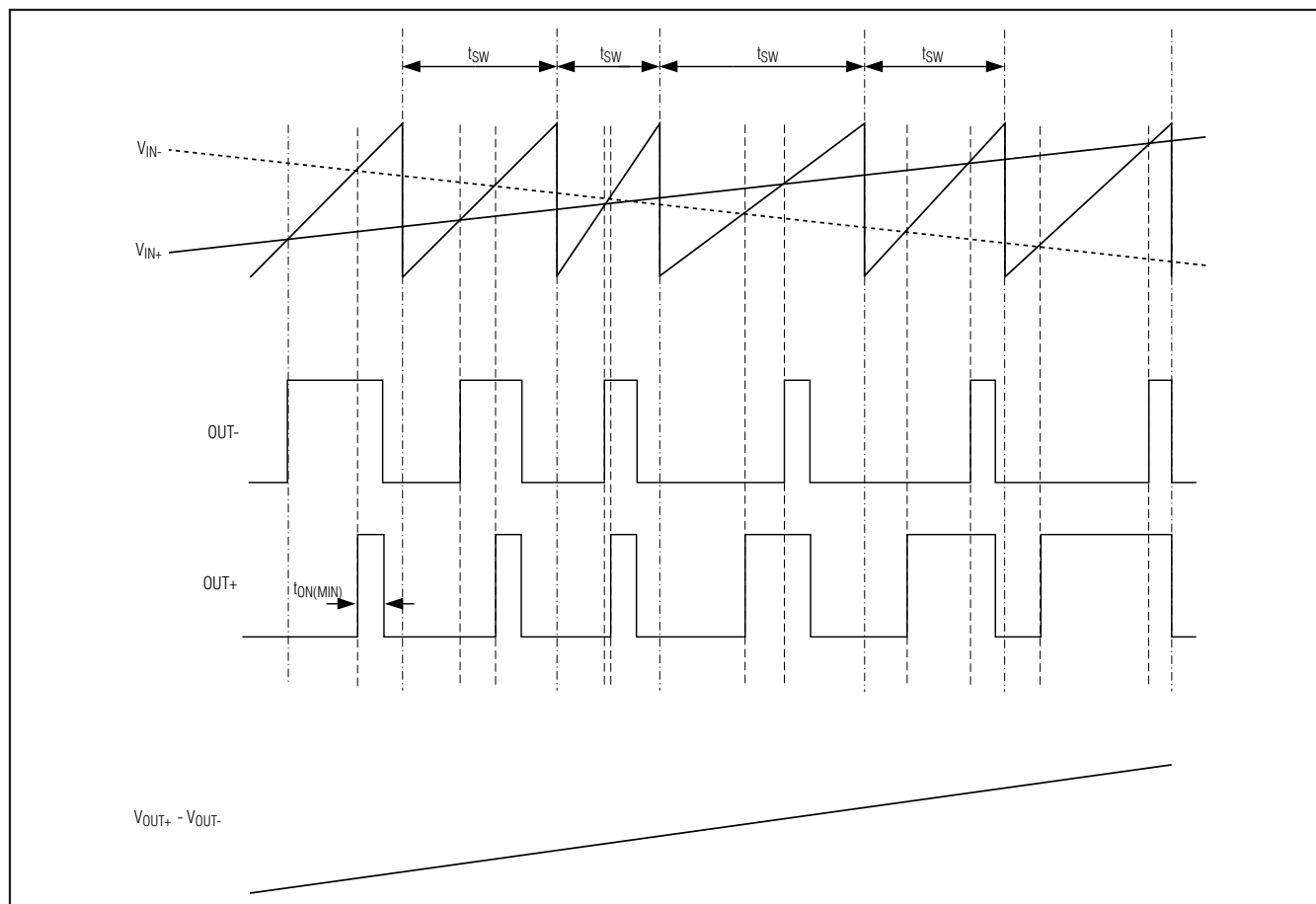

Figure 2. MAX9705 Output with an Input Signal Applied (SSM Mode)

### Filterless Modulation/Common-Mode Idle

The MAX9705 uses Maxim's unique, patented modulation scheme that eliminates the LC filter required by traditional Class D amplifiers, improving efficiency, reducing component count, and conserving board space and system cost. Conventional Class D amplifiers output a 50% duty cycle square wave when no signal is present. With no filter, the square wave appears across the load as a DC voltage, resulting in a finite load current, increasing power consumption. When no signal is present at the input of the MAX9705, the outputs switch as shown in Figure 3. Because the MAX9705 drives the speaker differentially, the two outputs cancel each other, resulting in no net idle-mode voltage across the speaker, minimizing power consumption.

### Efficiency

Efficiency of a Class D amplifier is attributed to the region of operation of the output stage transistors. In a

Class D amplifier, the output transistors act as current-steering switches and consume negligible additional power. Any power loss associated with the Class D output stage is mostly due to the  $I^2R$  loss of the MOSFET on-resistance and supply current.

The theoretical best efficiency of a linear amplifier is 78%; however, that efficiency is only exhibited at peak output powers. Under normal operating levels (typical music reproduction levels), efficiency falls below 30%, whereas the MAX9705 still exhibits >70% efficiencies under the same conditions (Figure 4).

### Shutdown

The MAX9705 has a shutdown mode that reduces power consumption and extends battery life. Driving  $\overline{\text{SHDN}}$  low places the MAX9705 in a low-power (0.3 $\mu\text{A}$ ) shutdown mode. Connect  $\overline{\text{SHDN}}$  to  $V_{\text{DD}}$  for normal operation.

## 2.3W, Ultra-Low-EMI, Filterless, Class D Audio Amplifier

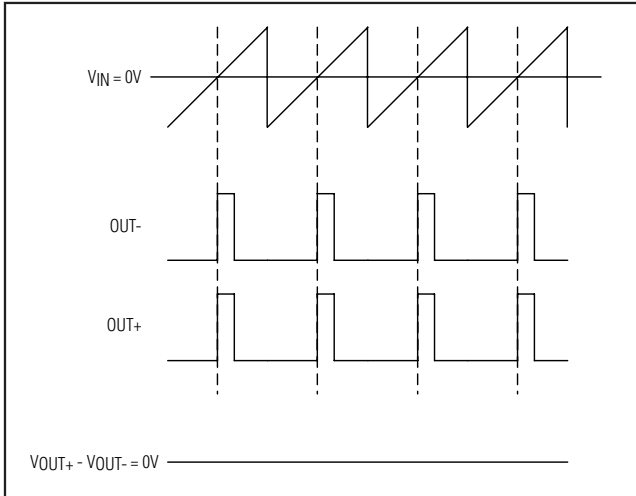

Figure 3. MAX9705 Outputs with No Input Signal

### Click-and-Pop Suppression

The MAX9705 features comprehensive click-and-pop suppression that eliminates audible transients on start-up and shutdown. While in shutdown, the H-bridge is in a high-impedance state. During startup or power-up, the input amplifiers are muted and an internal loop sets the modulator bias voltages to the correct levels, preventing clicks and pops when the H-bridge is subsequently enabled. For 30ms following startup, a soft-start function gradually unmutes the input amplifiers.

## Applications Information

### Filterless Operation

Traditional Class D amplifiers require an output filter to recover the audio signal from the amplifier's output. The filters add cost, increase the solution size of the amplifier, and can decrease efficiency and THD+N performance. The traditional PWM scheme uses large differential output swings ( $2 \times V_{DD}$  peak-to-peak) and causes large ripple currents. Any parasitic resistance in the filter components results in a loss of power, lowering the efficiency.

The MAX9705 does not require an output filter. The device relies on the inherent inductance of the speaker coil and the natural filtering of both the speaker and the human ear to recover the audio component of the square-wave output. Eliminating the output filter results in a smaller, less costly, more efficient solution.

Because the frequency of the MAX9705 output is well beyond the bandwidth of most speakers, voice coil movement due to the square-wave frequency is very small. Although this movement is small, a speaker not

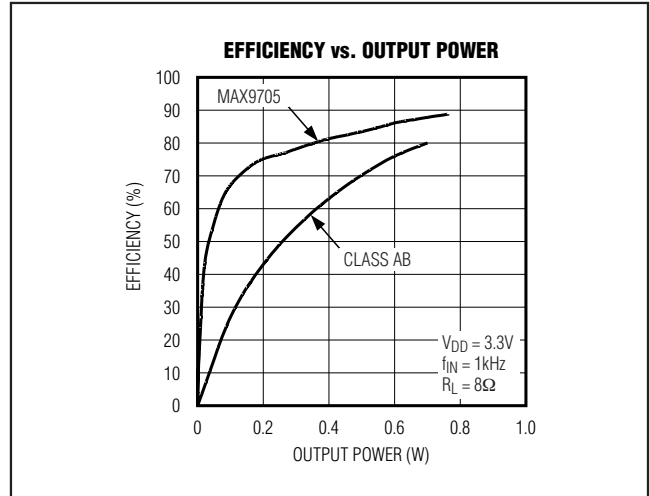

Figure 4. MAX9705 Efficiency vs. Class AB Efficiency

designed to handle the additional power can be damaged. For optimum results, use a speaker with a series inductance  $>10\mu\text{H}$ . Typical  $8\Omega$  speakers exhibit series inductances in the  $20\mu\text{H}$  to  $100\mu\text{H}$  range.

### Power-Conversion Efficiency

Unlike a class AB amplifier, the output offset voltage of a Class D amplifier does not noticeably increase quiescent-current draw when a load is applied. This is due to the power conversion of the Class D amplifier. For example, an 8mV DC offset across an  $8\Omega$  load results in 1mA extra current consumption in a Class AB device. In the Class D case, an 8mV offset into  $8\Omega$  equates to an additional power drain of  $8\mu\text{W}$ . Due to the high efficiency of the Class D amplifier, this represents an additional quiescent-current draw of  $8\mu\text{W}/(V_{DD}/100\eta)$ , which is on the order of a few microamps.

### Input Amplifier

#### Differential Input

The MAX9705 features a differential input structure, making it compatible with many CODECs, and offering improved noise immunity over a single-ended input amplifier. In devices such as cellular phones, high-frequency signals from the RF transmitter can be picked up by the amplifier's input traces. The signals appear at the amplifier's inputs as common-mode noise. A differential input amplifier amplifies the difference of the two inputs; any signal common to both inputs is canceled.

#### Single-Ended Input

The MAX9705 can be configured as a single-ended input amplifier by capacitively coupling either input to GND and driving the other input (Figure 5).

## 2.3W, Ultra-Low-EMI, Filterless, Class D Audio Amplifier

Note that the single-ended voltage range of the MAX9705A is 3V<sub>P-P</sub>. This limits the achievable output power for this device. Use higher gain versions (MAX9705B, MAX9705C, MAX9705D) if higher output power is desired in a single-ended application.

### DC-Coupled Input

The input amplifier can accept DC-coupled inputs that are biased within the amplifier's common-mode range (see the *Typical Operating Characteristics*). DC coupling eliminates the input-coupling capacitors, reducing component count to potentially one external component (see the *System Diagram*). However, the low-frequency rejection of the capacitors is lost, allowing low-frequency signals to feed through to the load.

### Component Selection

#### Input Filter

An input capacitor, C<sub>IN</sub>, in conjunction with the input resistance of the MAX9705 forms a highpass filter that removes the DC bias from an incoming signal. The AC-coupling capacitor allows the amplifier to bias the signal to an optimum DC level. Assuming zero source impedance, the -3dB point of the highpass filter is given by:

$$f_{-3dB} = \frac{1}{2\pi R_{IN} C_{IN}}$$

Choose C<sub>IN</sub> so f<sub>-3dB</sub> is well below the lowest frequency of interest. Setting f<sub>-3dB</sub> too high affects the low-frequency response of the amplifier. Use capacitors whose dielectrics have low-voltage coefficients, such as tantalum or aluminum electrolytic. Capacitors with high-voltage coefficients, such as ceramics, may result in increased distortion at low frequencies. If a ceramic capacitor is selected due to size constraints, use the largest package possible to minimize voltage coefficient effects. In addition, use X7R dielectrics as opposed to Y5V or Z5U.

Other considerations when designing the input filter include the constraints of the overall system and the actual frequency band of interest. Although high-fidelity audio calls for a flat gain response between 20Hz and 20kHz, portable voice-reproduction devices such as cellular phones and two-way radios need only concentrate on the frequency range of the spoken human voice (typically 300Hz to 3.5kHz). In addition, speakers used in portable devices typically have a poor response below 150Hz. Taking these two factors into considera-

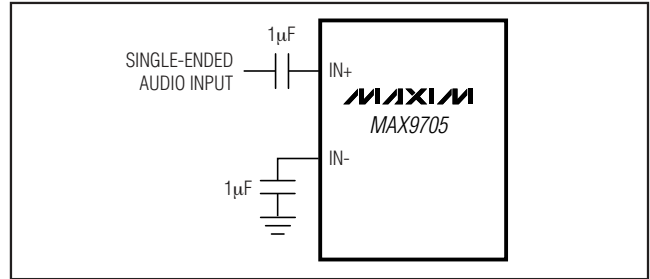

Figure 5. Single-Ended Input

tion, the input filter may not need to be designed for a 20Hz to 20kHz response, saving both board space and cost due to the use of smaller capacitors.

#### Output Filter

The MAX9705 does not require an output filter. The device passes FCC emissions standards with 24in of unshielded twisted-pair speaker cables. However, an output filter can be used if a design is failing radiated emissions due to board layout or excessive cable length, or the circuit is near EMI-sensitive devices.

#### Supply Bypassing/Layout

Proper power-supply bypassing ensures low-distortion operation. For optimum performance, bypass V<sub>DD</sub> to GND and P<sub>VDD</sub> to P<sub>PGND</sub> with separate 1µF capacitors as close to each pin as possible. A low-impedance, high-current power-supply connection to P<sub>VDD</sub> is assumed. Additional bulk capacitance should be added as required depending on the application and power-supply characteristics. GND and P<sub>PGND</sub> should be star connected to system ground. Refer to the MAX9705 evaluation kit for layout guidance.

#### Stereo Configuration

Two MAX9705s can be configured as a stereo amplifier (Figure 6). Device U1 is the master amplifier; its unfiltered output drives the SYNC input of the slave device (U2), synchronizing the switching frequencies of the two devices. Synchronizing two MAX9705s ensures that no beat frequencies occur within the audio spectrum. This configuration works when the master device is in either FFM or SSM mode. There is excellent THD+N performance and minimal crosstalk between devices due to the SYNC connection (Figures 7 and 8). U2 locks onto only the frequency present at SYNC, not the pulse width. The internal feedback loop of device U2 ensures that the audio component of U1's output is rejected.

# 2.3W, Ultra-Low-EMI, Filterless, Class D Audio Amplifier

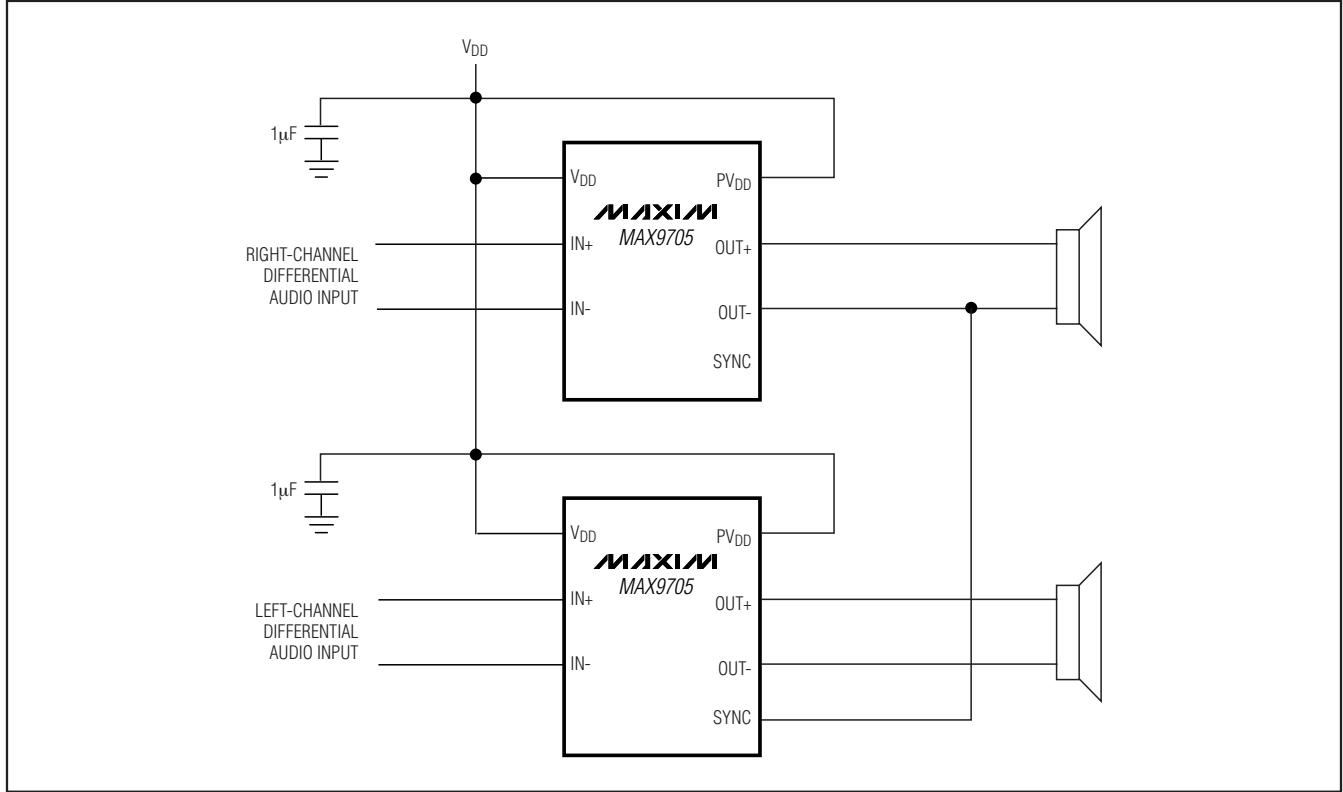

Figure 6. Master-Slave Stereo Configuration

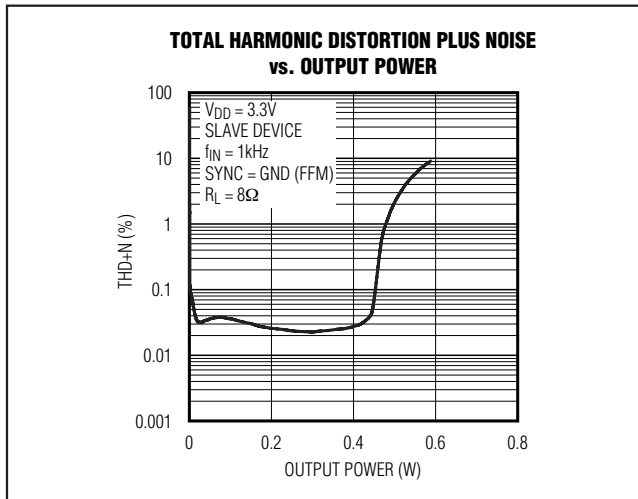

Figure 7. Master-Slave THD+N

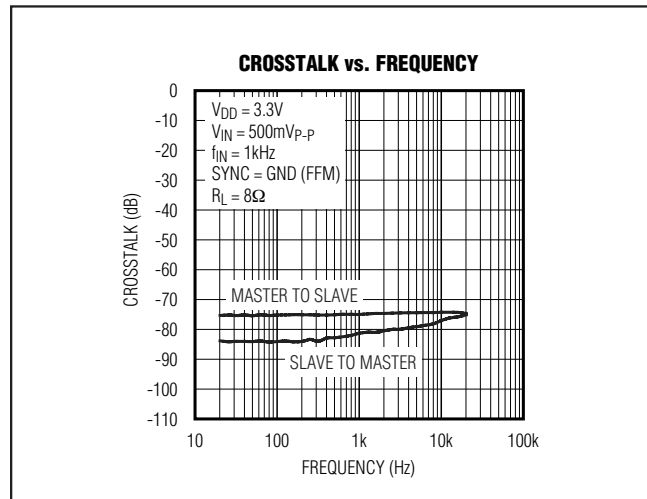

Figure 8. Master-Slave Crosstalk

# 2.3W, Ultra-Low-EMI, Filterless, Class D Audio Amplifier

**MAX9705**

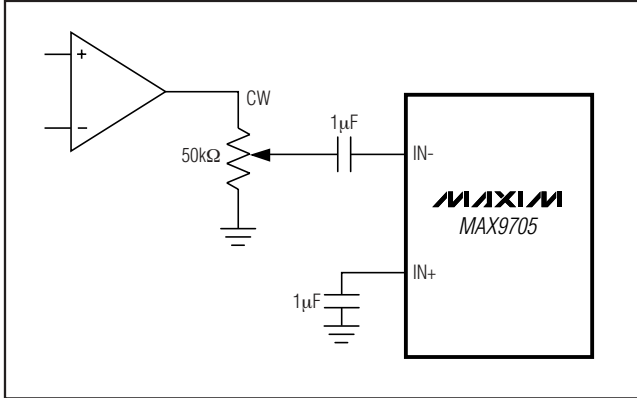

Figure 9a. Single-Ended Drive of MAX9705 Plus Volume

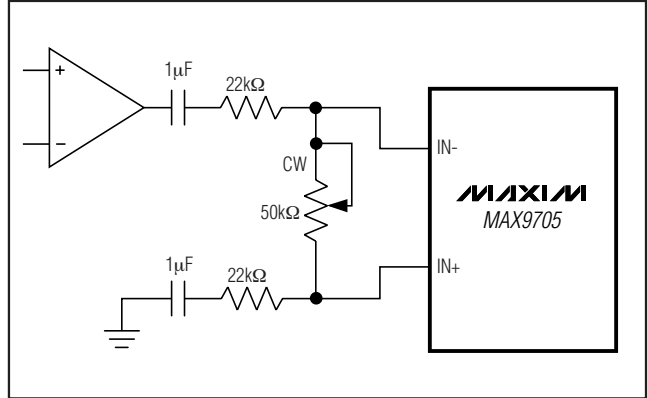
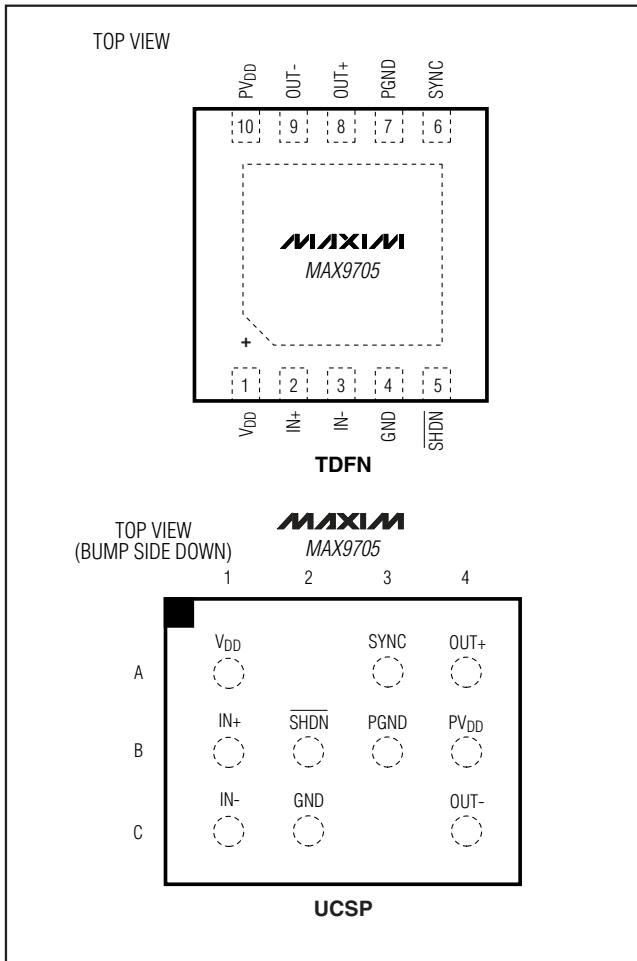

Figure 9b. Improved Single-Ended Drive of MAX9705 Plus Volume

## Pin Configurations



## Selector Guide

| PART          | PIN-PACKAGE | GAIN (dB) |
|---------------|-------------|-----------|
| MAX9705AETB+T | 10 TDFN     | 6         |
| MAX9705AEBC+T | 12 UCSP     | 6         |
| MAX9705BETB+T | 10 TDFN     | 12        |
| MAX9705BEBC+T | 12 UCSP     | 12        |
| MAX9705CETB+T | 10 TDFN     | 15.6      |
| MAX9705CEBC+T | 12 UCSP     | 15.6      |
| MAX9705DETB+T | 10 TDFN     | 20        |
| MAX9705DEBC+T | 12 UCSP     | 20        |

## Ordering Information (continued)

| PART          | TEMP RANGE     | PIN-PACKAGE | TOP MARK |
|---------------|----------------|-------------|----------|
| MAX9705CETB+T | -40°C to +85°C | 10 TDFN     | ACZ      |
| MAX9705CEBC+T | -40°C to +85°C | 12 UCSP     | ACI      |
| MAX9705DETB+T | -40°C to +85°C | 10 TDFN     | ADA      |
| MAX9705DEBC+T | -40°C to +85°C | 12 UCSP     | ACJ      |

+Denotes a lead-free/RoHS-compliant package.  
T = Tape and reel.

# 2.3W, Ultra-Low-EMI, Filterless, Class D Audio Amplifier

## System Diagram

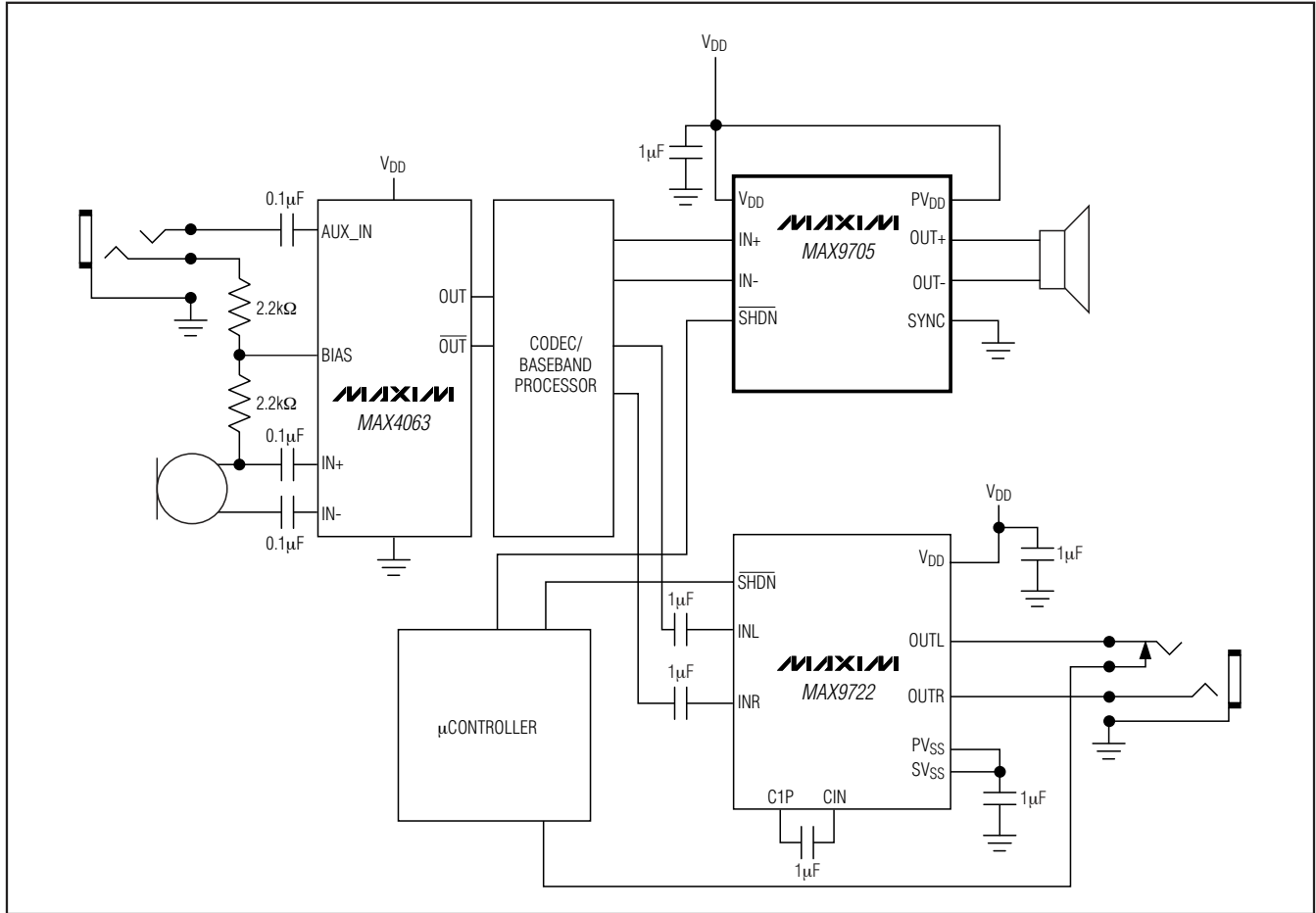

## Chip Information

TRANSISTOR COUNT: 3595

PROCESS: BiCMOS



# 2.3W, Ultra-Low-EMI, Filterless, Class D Audio Amplifier

## Package Information

For the latest package outline information and land patterns, go to [www.maxim-ic.com/packages](http://www.maxim-ic.com/packages).

MAX9705

12L UCSP 4x3.EPS

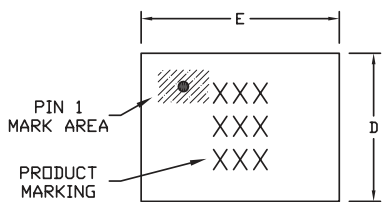

TOP VIEW

| COMMON DIMENSIONS |                |
|-------------------|----------------|
| A                 | 0.62±0.05-0.08 |
| A1                | 0.29±0.02      |
| A2                | 0.33 REF.      |
| b                 | ∅0.35±0.03     |
| D1                | 1.00 BASIC     |
| E1                | 1.50 BASIC     |
| e                 | 0.50 BASIC     |
| SD                | 0.00 BASIC     |
| SE                | 0.25 BASIC     |

| PKG. CODE | VARIABLE DIMENSIONS |           | DEPOPULATED SOLDER BALLS |
|-----------|---------------------|-----------|--------------------------|
|           | D                   | E         |                          |
| B12-1     | 1.54±0.05           | 2.02±0.05 | NONE                     |
| B12-2     | 1.54±0.05           | 2.02±0.05 | B3                       |
| B12-3     | 1.54±0.05           | 2.12±0.05 | NONE                     |
| B12-4     | 1.54±0.05           | 2.02±0.05 | B2, B3                   |
| B12-5     | 1.64±0.05           | 2.12±0.05 | B2                       |
| B12-6     | 1.64±0.05           | 2.12±0.05 | B3                       |
| B12-7     | 1.54±0.05           | 2.02±0.05 | B1, B3                   |
| B12-8     | 1.54±0.05           | 2.02±0.05 | B2                       |
| B12-9     | 1.54±0.05           | 2.12±0.05 | B2, B3                   |
| B12-10    | 1.54±0.05           | 2.02±0.05 | B1, B2, B3, B4           |
| B12-11    | 1.54±0.05           | 2.02±0.05 | A2, C3                   |

NOTES:

1. ALL DIMENSIONS ARE IN MILLIMETERS.
2. PRODUCT MARKING: NUMBER OF CHARACTERS AND LINES VARY PER PRODUCT.

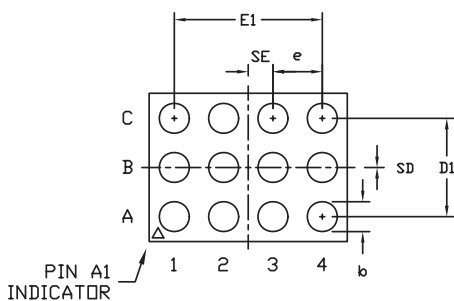

BOTTOM VIEW

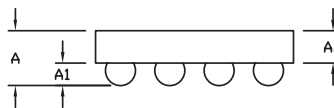

SIDE VIEW

|  |  |                          |                    |
|--|--|--------------------------|--------------------|
|  |  |                          |                    |
| <small>PROPRIETARY INFORMATION</small> |  |                          |                    |
| TITLE:<br>PACKAGE OUTLINE, 4x3 UCSP    |  |                          |                    |
| <small>APPROVAL</small>                | <small>DOCUMENT CONTROL NO.</small><br>21-0104 | <small>REV.</small><br>F | <small>1/1</small> |

# 2.3W, Ultra-Low-EMI, Filterless, Class D Audio Amplifier

## Package Information (continued)

For the latest package outline information and land patterns, go to [www.maxim-ic.com/packages](http://www.maxim-ic.com/packages).

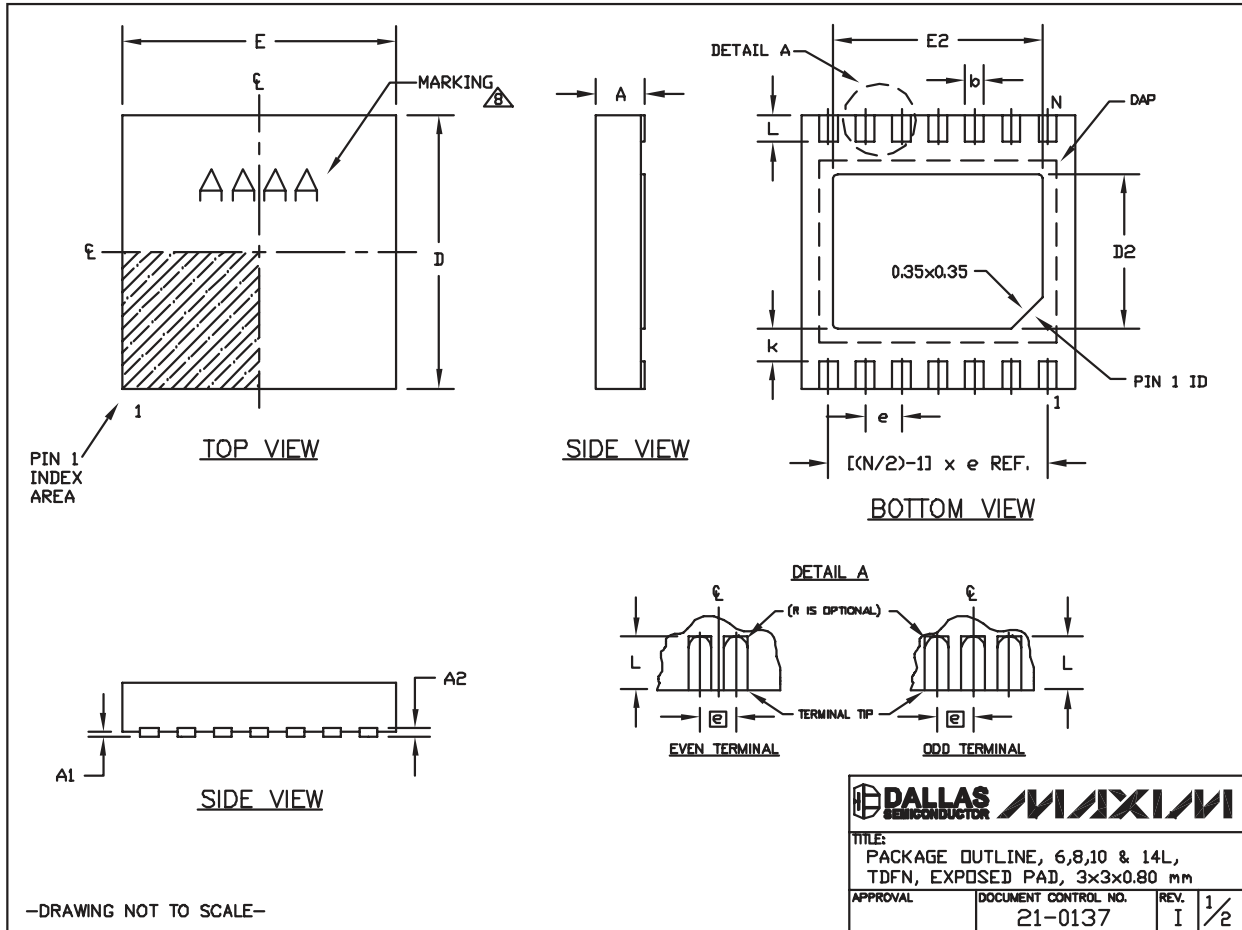

# 2.3W, Ultra-Low-EMI, Filterless, Class D Audio Amplifier

## Package Information (continued)

For the latest package outline information and land patterns, go to [www.maxim-ic.com/packages](http://www.maxim-ic.com/packages).

MAX9705

| COMMON DIMENSIONS |           |      |
|-------------------|-----------|------|
| SYMBOL            | MIN.      | MAX. |
| A                 | 0.70      | 0.80 |
| D                 | 2.90      | 3.10 |
| E                 | 2.90      | 3.10 |
| A1                | 0.00      | 0.05 |
| L                 | 0.20      | 0.40 |
| k                 | 0.25 MIN. |      |
| A2                | 0.20 REF. |      |

| PACKAGE VARIATIONS |    |           |           |          |                |           |               |
|--------------------|----|-----------|-----------|----------|----------------|-----------|---------------|
| PKG. CODE          | N  | D2        | E2        | e        | JEDEC SPEC     | b         | [(N/2)-1] x e |
| T633-2             | 6  | 1.50±0.10 | 2.30±0.10 | 0.95 BSC | MO229 / WEEA   | 0.40±0.05 | 1.90 REF      |
| T833-2             | 8  | 1.50±0.10 | 2.30±0.10 | 0.65 BSC | MO229 / WEEC   | 0.30±0.05 | 1.95 REF      |
| T833-3             | 8  | 1.50±0.10 | 2.30±0.10 | 0.65 BSC | MO229 / WEEC   | 0.30±0.05 | 1.95 REF      |
| T1033-1            | 10 | 1.50±0.10 | 2.30±0.10 | 0.50 BSC | MO229 / WEED-3 | 0.25±0.05 | 2.00 REF      |
| T1033-2            | 10 | 1.50±0.10 | 2.30±0.10 | 0.50 BSC | MO229 / WEED-3 | 0.25±0.05 | 2.00 REF      |
| T1433-1            | 14 | 1.70±0.10 | 2.30±0.10 | 0.40 BSC | ----           | 0.20±0.05 | 2.40 REF      |
| T1433-2            | 14 | 1.70±0.10 | 2.30±0.10 | 0.40 BSC | ----           | 0.20±0.05 | 2.40 REF      |

**NOTES:**

1. ALL DIMENSIONS ARE IN mm. ANGLES IN DEGREES.
  2. COPLANARITY SHALL NOT EXCEED 0.08 mm.
  3. WARPAGE SHALL NOT EXCEED 0.10 mm.
  4. PACKAGE LENGTH/PACKAGE WIDTH ARE CONSIDERED AS SPECIAL CHARACTERISTIC(S).
  5. DRAWING CONFORMS TO JEDEC MO229, EXCEPT DIMENSIONS "D2" AND "E2", AND T1433-1 & T1433-2.
  6. "N" IS THE TOTAL NUMBER OF LEADS.
  7. NUMBER OF LEADS SHOWN ARE FOR REFERENCE ONLY.
-  MARKING IS FOR PACKAGE ORIENTATION REFERENCE ONLY.

—DRAWING NOT TO SCALE—

|   |                      |      |     |
|---|----------------------|------|-----|
|  |                      |      |     |
| <b>TITLE:</b><br>PACKAGE OUTLINE, 6,8,10 & 14L,<br>TDFN, EXPOSED PAD, 3x3x0.80 mm     |                      |      |     |
| APPROVAL  | DOCUMENT CONTROL NO. | REV. |     |
|   | 21-0137              | I    | 2/2 |

| PACKAGE TYPE | PACKAGE CODE | DOCUMENT NO.            |
|--------------|--------------|-------------------------|
| 10 TDFN      | T1033-1      | <a href="#">21-0137</a> |
| 12 UCSP      | B12-11       | <a href="#">21-0104</a> |

# 2.3W, Ultra-Low-EMI, Filterless, Class D Audio Amplifier

## Revision History

| REVISION NUMBER | REVISION DATE | DESCRIPTION                      | PAGES CHANGED  |
|-----------------|---------------|----------------------------------|----------------|
| 2               | 8/08          | Removed $\mu$ MAX package option | 1-7, 9, 10, 15 |

Maxim cannot assume responsibility for use of any circuitry other than circuitry entirely embodied in a Maxim product. No circuit patent licenses are implied. Maxim reserves the right to change the circuitry and specifications without notice at any time.

20 \_\_\_\_\_ **Maxim Integrated Products, 120 San Gabriel Drive, Sunnyvale, CA 94086 408-737-7600**