

External GPS/GLONASS + LTE MIMO + WiFi MIMO Antenna



AEACBK110053-MLWG



Ø110.0 x 53.0 mm
RoHS/RoHS II Compliant
MSL = 1

Features

- 2 x 4G/LTE
- 2 x WiFi 2.4/5.5 GHz
- Active GPS/GLONASS
- Active GNSS with LNA gain of 28 dB
- RHCP for GNSS
- Linear polarized LTE and WiFi
- IP67 rated
- Screw mount

Applications

- 4G/LTE/3G/2G/GSM applications
- GNSS/GPS/GLONASS
- Gateways and routers
- WiFi 2.4/5.5 GHz
- Telematics
- M2M
- IoT and Industrial IoT
- Geolocation and tracking
- Transportation and agriculture
- Smart city

Electrical Characteristics

Parameters	Min.	Typ.	Max	Units	Note
LTE MIMO Antenna					
Frequency Range		698-960/1710-2690		MHz	
VSWR			3.0		
Polarization	Linear				
Impedance		50		Ω	
Gain		3.0		dBi	
GNSS (GPS & GLONASS) Antenna					
Center Frequency		1575.42-1610		MHz	
Polarization	RHCP				
Impedance		50			
Dimension		25.0 x 25.0 x 6.0		mm	
GNSS LNA					
Gain		28±2		dB	
Noise Figure			1.5	dB	
VSWR			2.0		
Supply Voltage	3.0		5.0	V	DC
Current Consumption			15	mA	
WiFi MIMO Antenna					
Frequency Range		2400-2483.5MHz/ 4900 - 5825MHz		MHz	
VSWR			2.5		
Polarization	Linear				
Impedance		50		Ω	
Gain		2.0		dBi	

External GPS/GLONASS + LTE MIMO + WiFi MIMO Antenna



AEACBK110053-MLWG



Ø110.0 x 53.0 mm
RoHS/RoHS II Compliant
MSL = 1

Mechanical Characteristics

Parameters	Description
Connector	SMA Male
Cable Type	3 x RG174 (LTE MIMO +GNSS)+ 2 x LMR100 (WiFi MIMO)
Cable Length	3M
Radome Material	ABS
Mounting Method	Screw
Dimensions	Ø110.0 x 53.0 mm

Environmental Characteristics

Parameters	Description
Waterproof	IP67 (exclude cable outlet)
Operating Temperature	-40 ~ +85°C
Relative Humidity	Up to 95%
MSL Level	1
ROHS Complaint	Yes
Vibration	10 to 55Hz with 1.5mm amplitude 2 hours

Dimensions

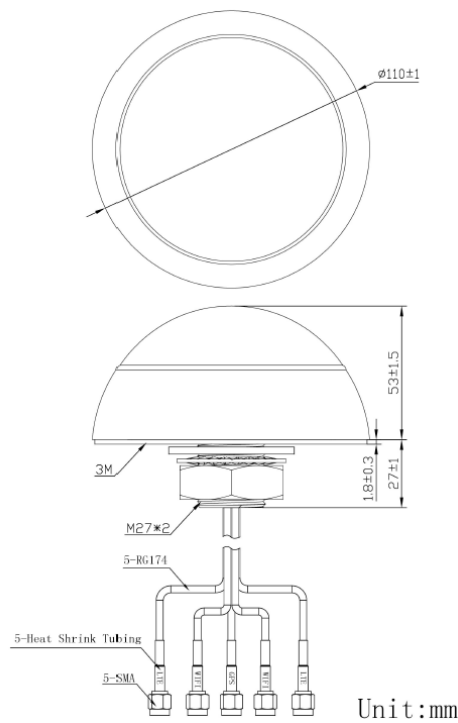

External GPS/GLONASS + LTE MIMO + WiFi MIMO Antenna



AEACBK110053-MLWG



Ø110.0 x 53.0 mm
RoHS/RoHS II Compliant
MSL = 1

Product Image



VSWR Characteristics

LTE

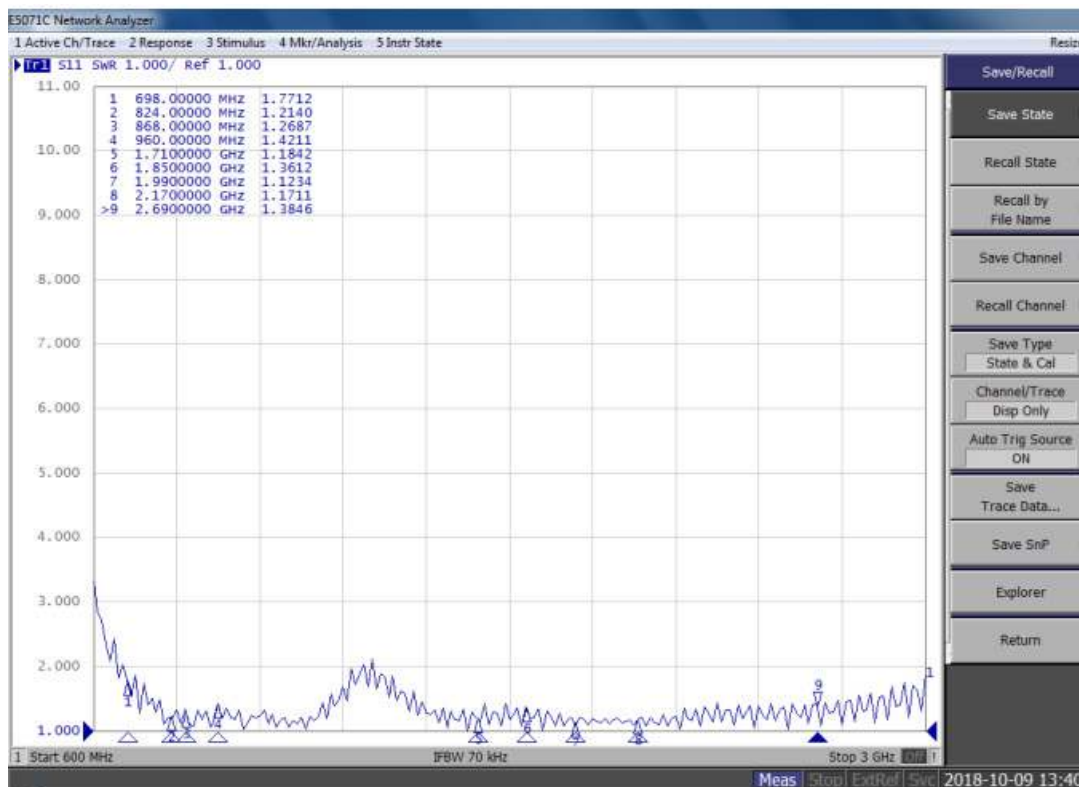

External GPS/GLONASS + LTE MIMO + WiFi MIMO Antenna



AEACBK110053-MLWG



Ø110.0 x 53.0 mm
RoHS/RoHS II Compliant
MSL = 1

VSWR Characteristics

WiFi

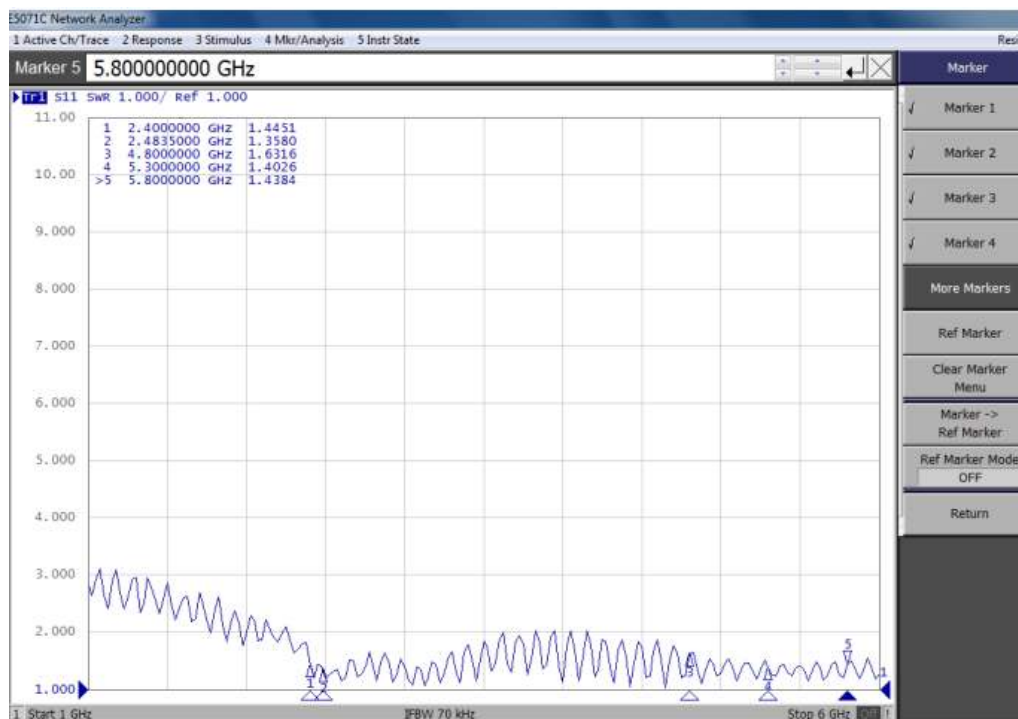

Gain and Efficiency

Frequency (MHz)	Efficiency	Gain (dBi)
698.0	0.52	2.05
824.0	0.57	2.18
868.0	0.67	2.89
960.0	0.58	1.1
1710.0	0.57	0.8
1850.0	0.52	0.45
1990.0	0.57	0.81
2170.0	0.61	1.87
2690.0	0.56	1.69
2400.0	0.63	0.67
2450.0	0.62	1.75
2483.5	0.59	1.96
4800.0	0.57	0.83
5300.0	0.56	1.85
5800.0	0.58	1.75

External GPS/GLONASS + LTE MIMO + WiFi MIMO Antenna



AEACBK110053-MLWG



Ø110.0 x 53.0 mm
RoHS/RoHS II Compliant
MSL = 1

Radiation Patterns

2D Radiation Patterns
GPS Antenna

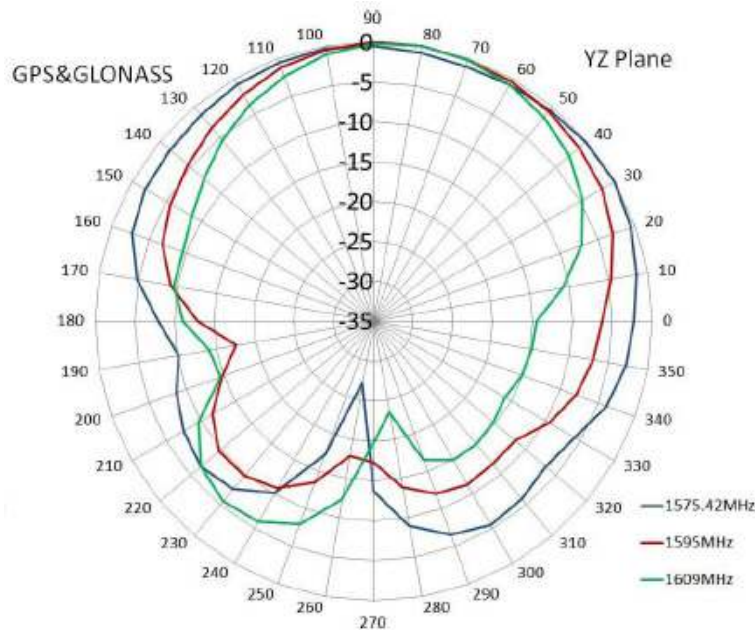
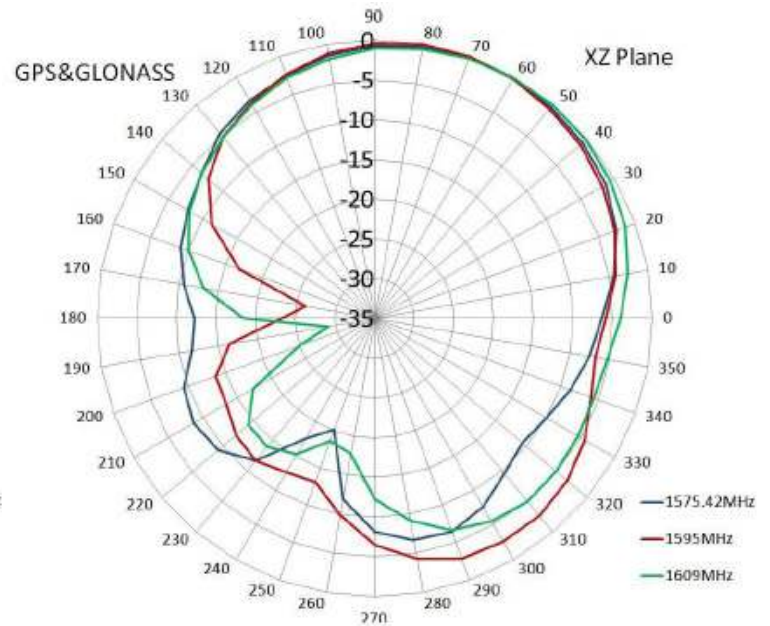
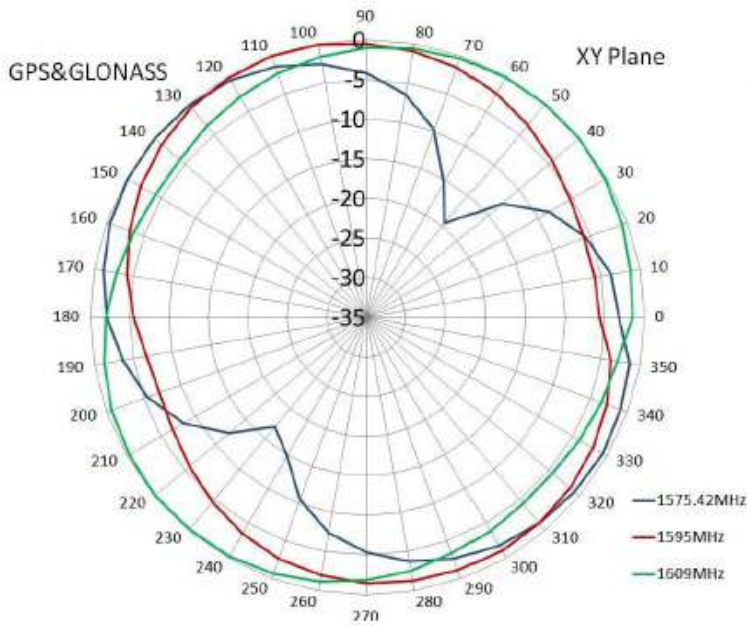

External GPS/GLONASS + LTE MIMO + WiFi MIMO Antenna



AEACBK110053-MLWG



Ø110.0 x 53.0 mm
RoHS/RoHS II Compliant
MSL = 1

LTE Antenna

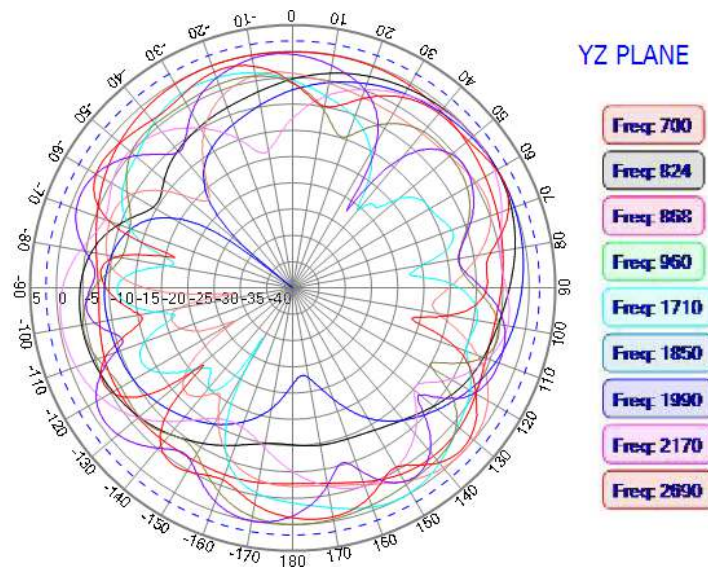
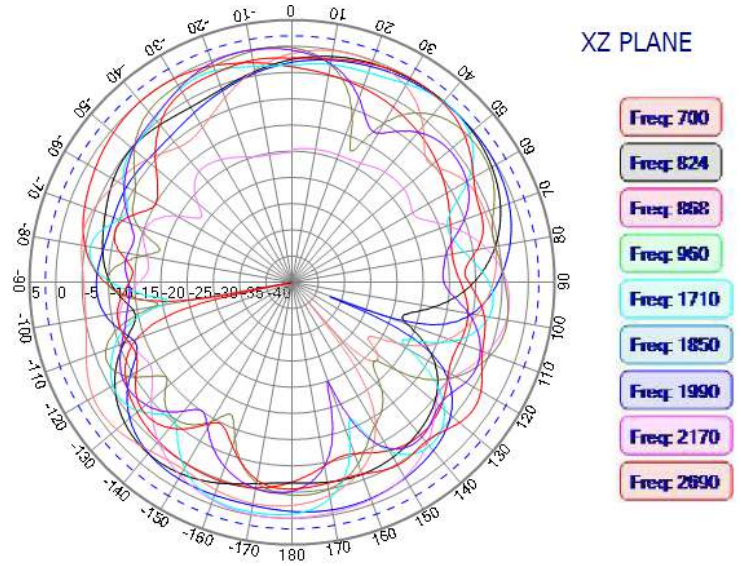
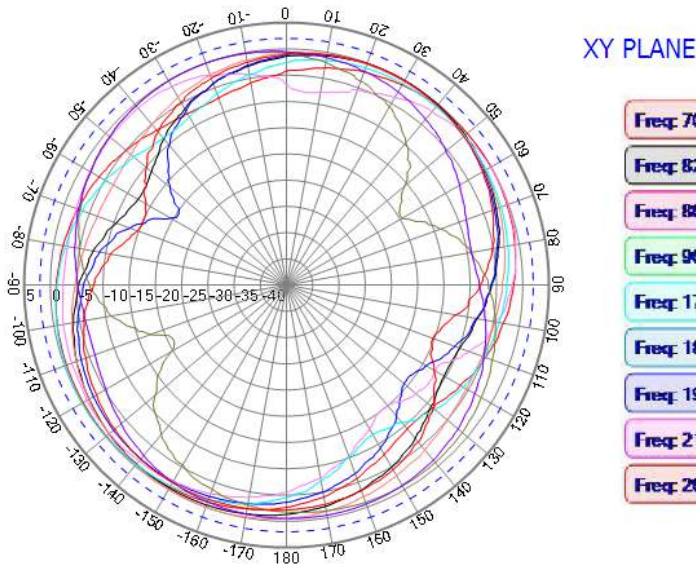

External GPS/GLONASS + LTE MIMO + WiFi MIMO Antenna



AEACBK110053-MLWG



Ø110.0 x 53.0 mm
RoHS/RoHS II Compliant
MSL = 1

WiFi Antenna

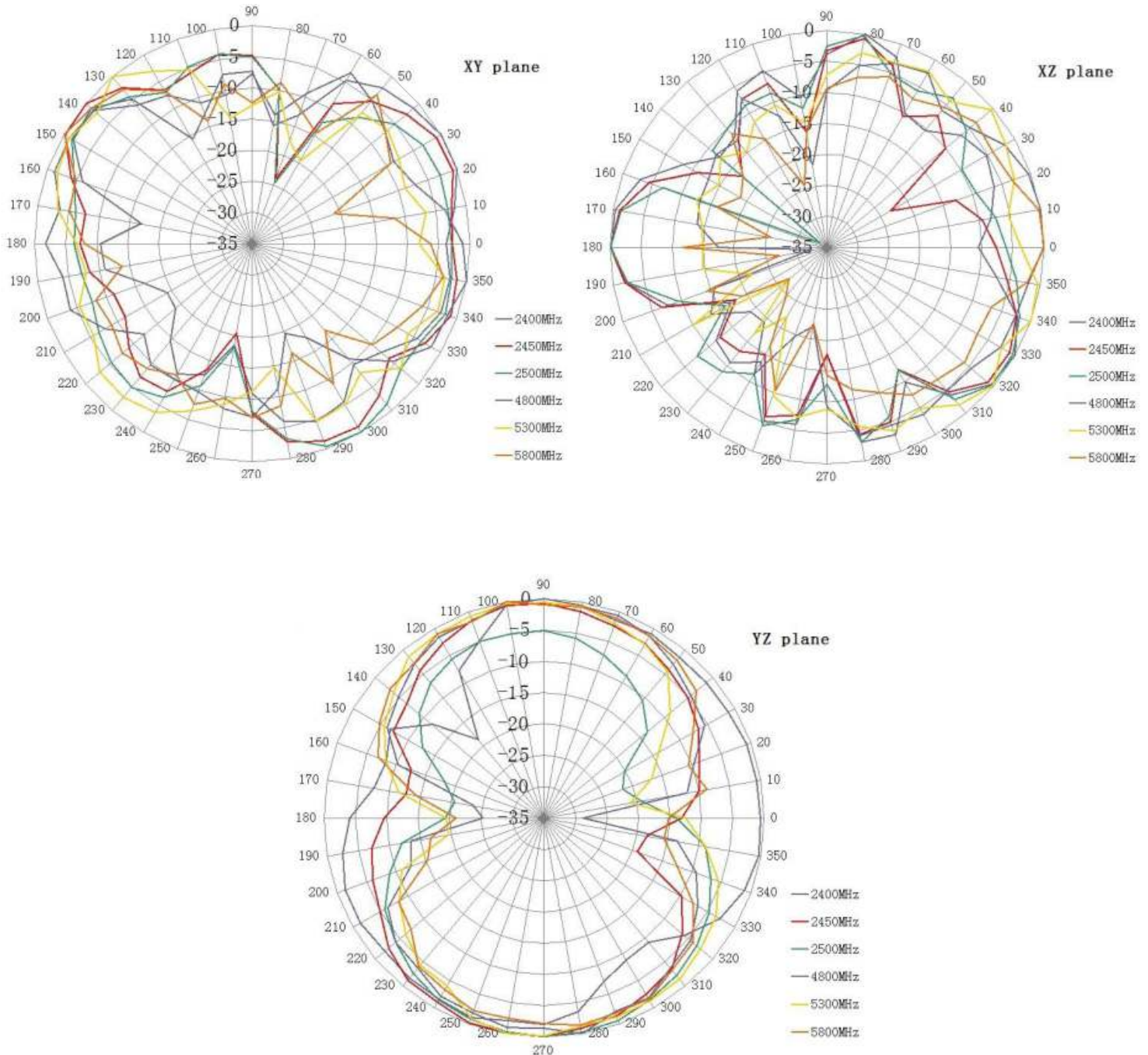

External GPS/GLONASS + LTE MIMO + WiFi MIMO Antenna



AEACBK110053-MLWG



Ø110.0 x 53.0 mm
RoHS/RoHS II Compliant
MSL = 1

3D Radiation Patterns

GPS/GLONASS Antenna

1575.42MHz

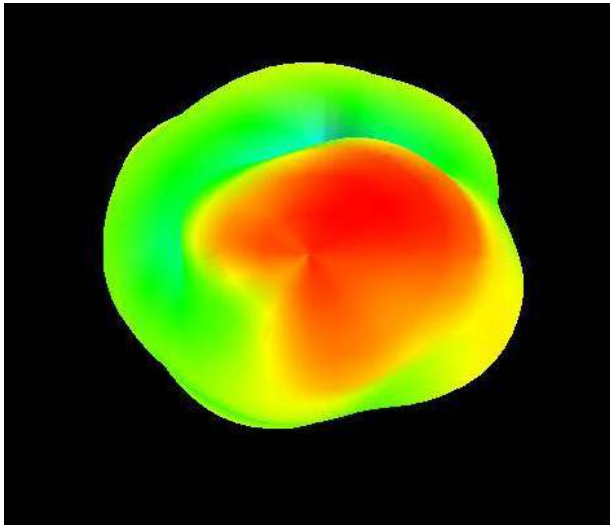

1610MHz

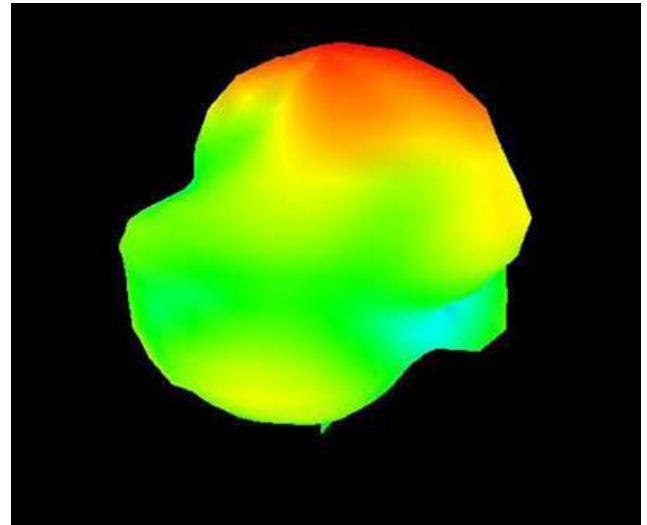

LTE Antenna

698 MHz

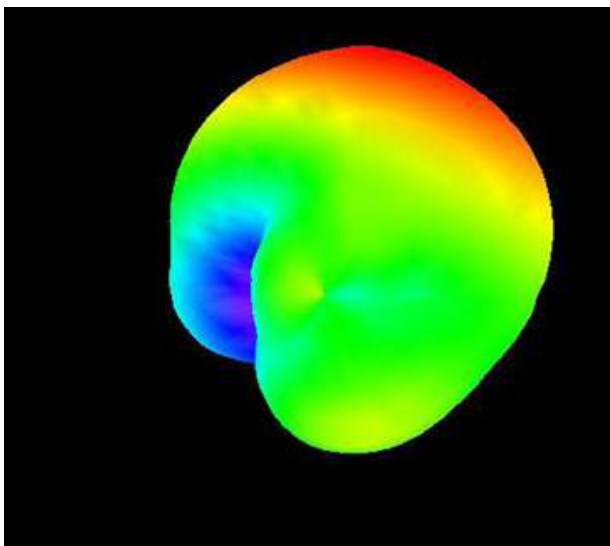

824 MHz

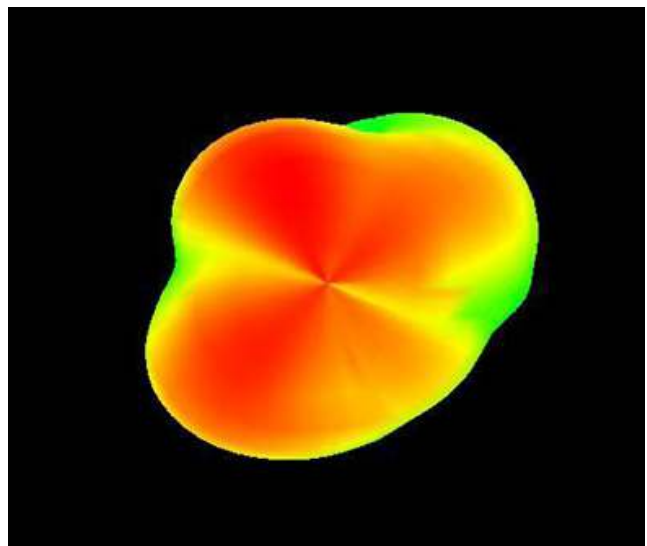

External GPS/GLONASS + LTE MIMO + WiFi MIMO Antenna



AEACBK110053-MLWG



Ø110.0 x 53.0 mm
RoHS/RoHS II Compliant
MSL = 1

3D Radiation Patterns

868 MHz

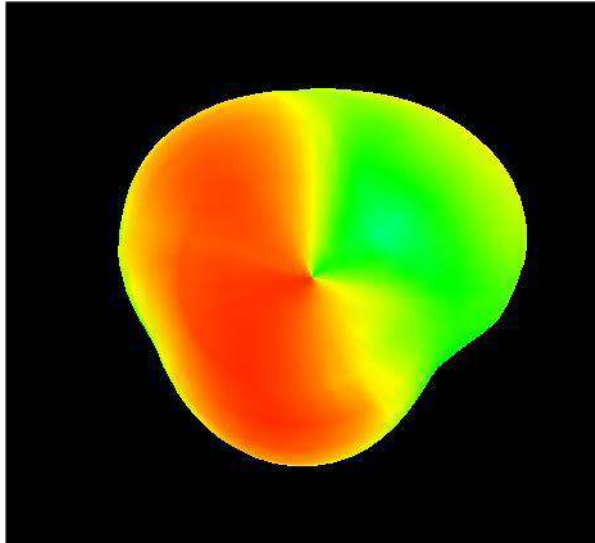

960 MHz

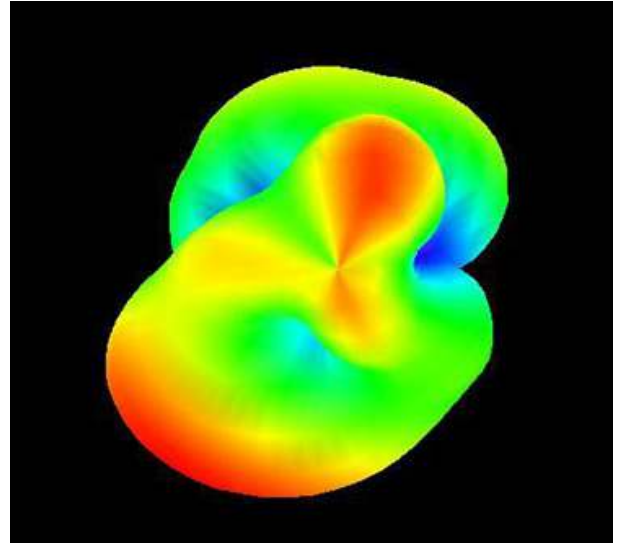

1710 MHz

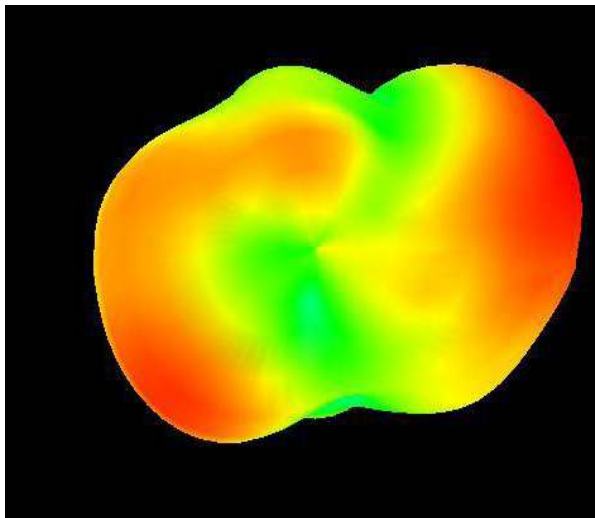

1850 MHz

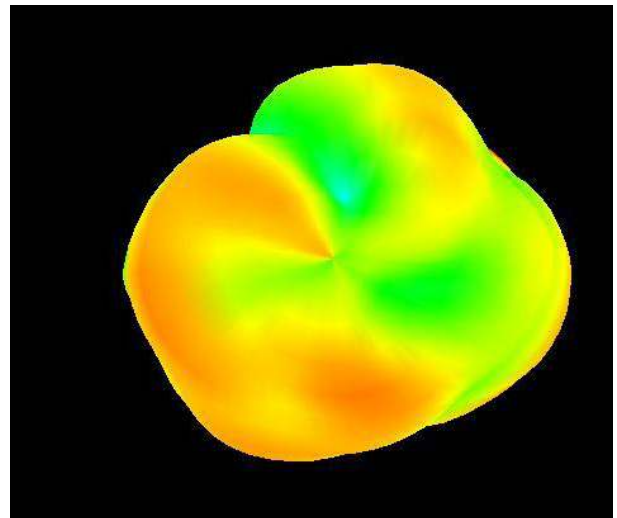

External GPS/GLONASS + LTE MIMO + WiFi MIMO Antenna



AEACBK110053-MLWG



Ø110.0 x 53.0 mm
RoHS/RoHS II Compliant
MSL = 1

3D Radiation Patterns

1990 MHz

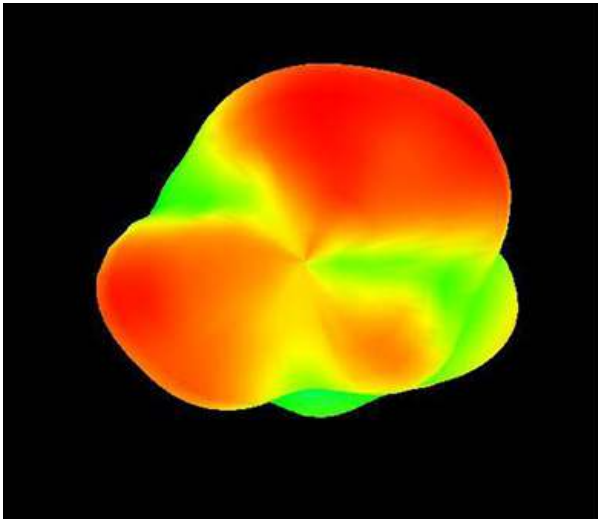

2170 MHz

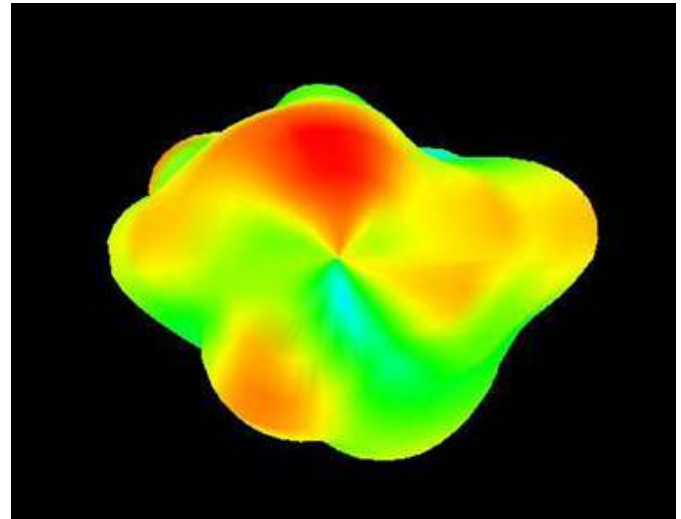

2690 MHz

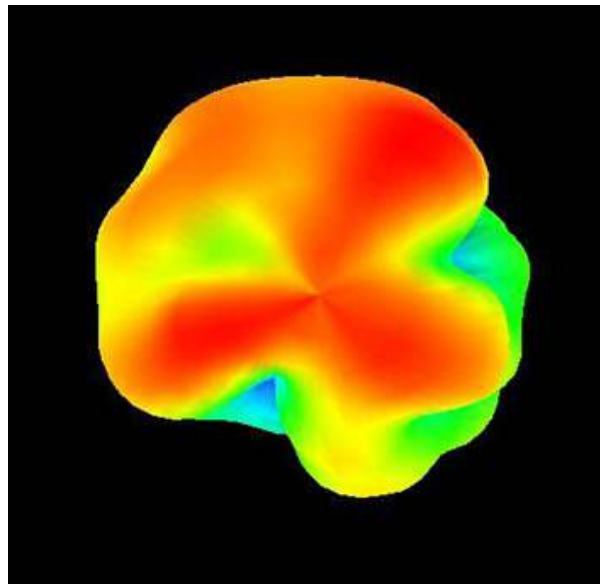

External GPS/GLONASS + LTE MIMO + WiFi MIMO Antenna



AEACBK110053-MLWG



Ø110.0 x 53.0 mm
RoHS/RoHS II Compliant
MSL = 1

3D Radiation Patterns

WiFi Antenna

2400MHz

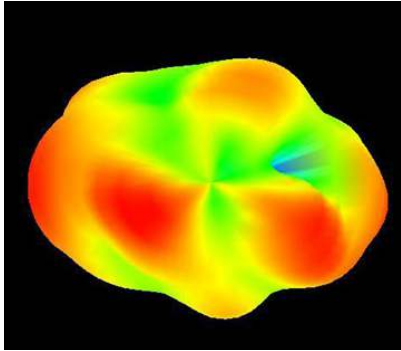

2483.5MHz

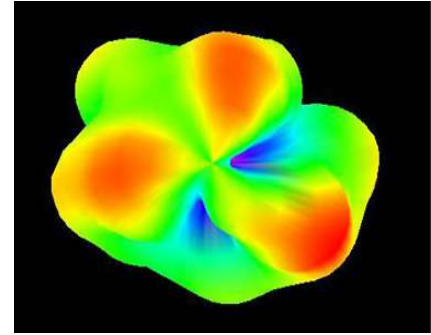

4800MHz

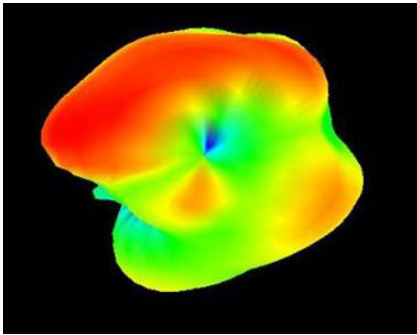

5300MHz

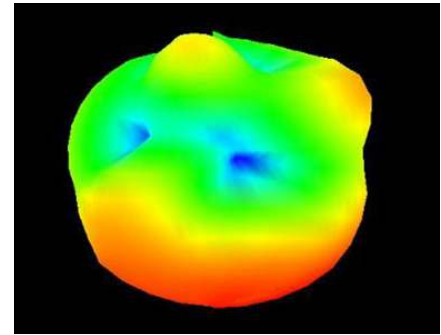

5800MHz

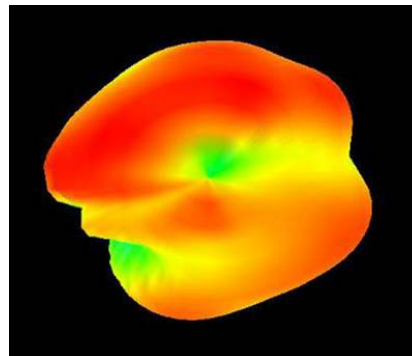

Packaging

Each 51 x 27 x 26 cm size carton includes 16 pcs antenna and weighs 11 Kg.

ATTENTION: Abracon LLC's products are COTS – Commercial-Off-The-Shelf products; suitable for Commercial, Industrial and, where designated, Automotive Applications. Abracon's products are not specifically designed for Military, Aviation, Aerospace, Life-dependent Medical applications or any application requiring high reliability where component failure could result in loss of life and/or property. For applications requiring high reliability and/or presenting an extreme operating environment, written consent and authorization from Abracon LLC is required. Please contact Abracon LLC for more information.



5101 Hidden Creek Ln Spicewood TX 78669
Phone: 512-371-6159 | Fax: 512-351-8858
For terms and conditions of sales, please visit:
www.abracon.com

REVISED: 07.31.2020

ABRACON IS
ISO9001-2015
CERTIFIED