

Bridgelux® Gen 8 V8 Array

Product Data Sheet DS411



Introduction

V Series



The V Series™ LED Array products deliver high quality light in a compact and cost-effective solid-state lighting package. These chip on board (CoB) arrays can be efficiently driven up to three times the nominal drive current, enabling design flexibility not previously possible. These high flux density light sources are designed to support a wide range of high quality, low cost directional luminaires and replacement lamps for both interior and exterior commercial and residential applications.

The V8 LED Array is available in a variety of electrical, CCT, and CRI combinations providing substantial design flexibility and energy efficiency advantages.

Lighting system designs incorporating these LED arrays deliver increased system level efficacy and a longer service life. Typical applications include replacement lamps and task, accent, spot, track, wide area, security, wall packs and down lights.

Features

- Efficacy of 178 lm/W typical for 3000K, 80 CRI
- Compact high flux density light source
- Uniform, high quality illumination
- Minimum 70, 80, and 90 CRI options
- Streamlined thermal path
- ENERGY STAR® / ANSI compliant color binning structure with 2, 3 and 4 SDCM standard
- More energy efficient than incandescent, halogen and fluorescent lamps
- Low voltage DC operation
- Instant light with unlimited dimming
- V_f bin code backside marking

Benefits

- Enhanced optical control
- Clean white light without pixilation
- High quality, true color reproduction
- Significantly reduced thermal resistance and increased operating temperatures
- Uniform, consistent white light
- Lower operating costs
- Easy to use with daylight and motion detectors to enable increased energy savings
- Reduced maintenance costs
- Environmentally friendly, no disposal issues



Contents

Product Feature Map	2
Product Nomenclature	2
Product Selection Guide	3
Performance at Commonly Used Drive Currents	7
Electrical Characteristics	14
Eye Safety	15
Absolute Maximum Ratings	16
Performance Curves	17
Typical Color Spectrum	19
Typical Radiation Pattern	20
Mechanical Dimensions	21
Color Binning Information	22
Packaging and Labeling	23
Design Resources	25
Precautions	25
Disclaimers	25
About Bridgelux	26

Product Feature Map

Bridgelux arrays are fully engineered devices that provide consistent thermal and optical performance on an engineered mechanical platform. The V Series arrays are the most compact CoB devices across all of Bridgelux's LED Array products.

The arrays incorporate several features to simplify design integration and assembly. Please visit www.bridgelux.com for more information on the V Series family of products.

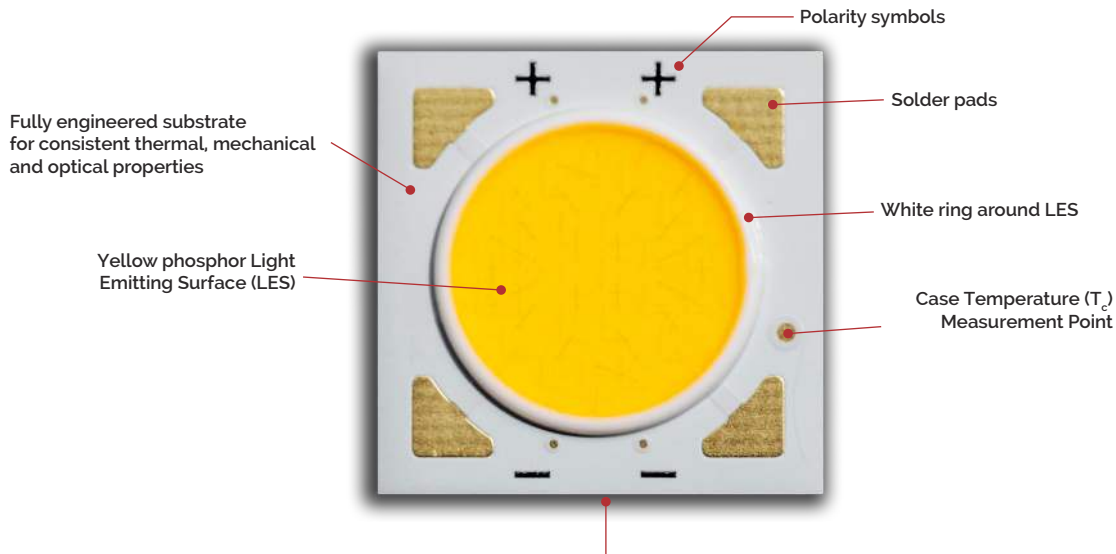

Note: Part number and lot codes are scribed on back of array

Product Nomenclature

The part number designation for Bridgelux V Series LED arrays is explained as follows:

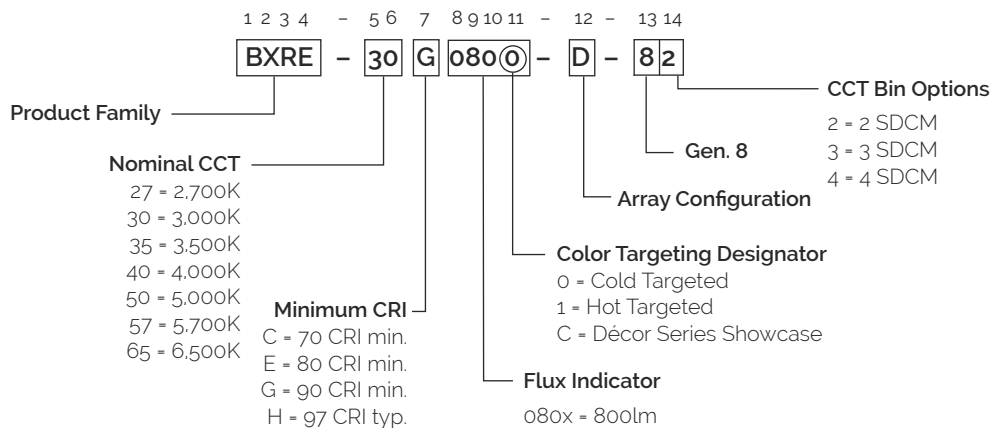

Product Selection Guide

The following product configurations are available:

Table 1: Selection Guide, Pulsed Measurement Data ($T_j = T_c = 25^\circ\text{C}$)

Part Number	Nominal CCT ¹ (K)	CRI ²	Nominal Drive Current ³ (mA)	Typical Pulsed Flux ^{4,5,6} $T_c = 25^\circ\text{C}$ (lm)	Minimum Pulsed Flux ^{6,7} $T_c = 25^\circ\text{C}$ (lm)	Typical V_f (V)	Typical Power (W)	Typical Efficacy (lm/W)
BXRE-27E0800-D-8x	2700	80	300	842	741	16.8	5.0	167
BXRE-27E0800-E-8x	2700	80	150	842	741	33.5	5.0	168
BXRE-27G0800-D-8x	2700	90	300	695	612	16.8	5.0	138
BXRE-27G0800-E-8x	2700	90	150	695	612	33.5	5.0	138
BXRE-27G08H0-D-8x	2700	90	300	725	638	16.8	5.0	144
BXRE-27G08H0-E-8x	2700	90	150	725	638	33.5	5.0	144
BXRE-27H0800-D-8x	2700	97	300	616	542	16.8	5.0	122
BXRE-27H0800-E-8x	2700	97	150	616	542	33.5	5.0	123
BXRE-30C0801-D-8x	3000	70	300	937	825	16.8	5.0	186
BXRE-30C0801-E-8x	3000	70	150	937	825	33.5	5.0	186
BXRE-30E0800-D-8x	3000	80	300	895	788	16.8	5.0	178
BXRE-30E0800-E-8x	3000	80	150	895	788	33.5	5.0	178
BXRE-30G0800-D-8x	3000	90	300	727	639	16.8	5.0	144
BXRE-30G0800-E-8x	3000	90	150	727	639	33.5	5.0	145
BXRE-30G08H0-D-8x	3000	90	300	761	669	16.8	5.0	151
BXRE-30G08H0-E-8x	3000	90	150	761	669	33.5	5.0	151
BXRE-30H0800-D-8x	3000	97	300	658	579	16.8	5.0	131
BXRE-30H0800-E-8x	3000	97	150	658	579	33.5	5.0	131
BXRE-35E0800-D-8x	3500	80	300	916	806	16.8	5.0	182
BXRE-35E0800-E-8x	3500	80	150	916	806	33.5	5.0	182
BXRE-35G0800-D-8x	3500	90	300	753	663	16.8	5.0	149
BXRE-35G0800-E-8x	3500	90	150	753	663	33.5	5.0	150
BXRE-40C0801-D-8x	4000	70	300	963	848	16.8	5.0	191
BXRE-40C0801-E-8x	4000	70	150	963	848	33.5	5.0	192
BXRE-40E0800-D-8x	4000	80	300	921	811	16.8	5.0	183
BXRE-40E0800-E-8x	4000	80	150	921	811	33.5	5.0	183
BXRE-40G0800-D-8x	4000	90	300	769	676	16.8	5.0	153
BXRE-40G0800-E-8x	4000	90	150	769	676	33.5	5.0	153
BXRE-50C0801-D-8x	5000	70	300	969	852	16.8	5.0	192
BXRE-50C0801-E-8x	5000	70	150	969	852	33.5	5.0	193
BXRE-50E0801-D-8x	5000	80	300	932	820	16.8	5.0	185
BXRE-50E0801-E-8x	5000	80	150	932	820	33.5	5.0	185
BXRE-50G0801-D-8x	5000	90	300	806	709	16.8	5.0	160
BXRE-50G0801-E-8x	5000	90	150	806	709	33.5	5.0	160

Notes for Table 1:

- Nominal CCT as defined by ANSI C78.377-2011.
- CRI values are minimums and tested at $T_j = T_c = 25^\circ\text{C}$. Minimum Rg value for 80 CRI products is 0, the minimum Rg values for 90 CRI products is 50, the minimum Rg values for 97 CRI products is 93. Bridgelux maintains a ± 3 tolerance on CRI and Rg values.
- Drive current is referred to as nominal drive current.
- Products tested under pulsed condition (10ms pulse width) at nominal test current where T_j (junction temperature) - T_c (case temperature) = 25°C .
- Typical performance values are provided as a reference only and are not a guarantee of performance.
- Bridgelux maintains a $\pm 7\%$ tolerance on flux measurements.
- Minimum flux values at the nominal test current are guaranteed by 100% test.

Product Selection Guide

Table 1: Selection Guide, Pulsed Measurement Data ($T_j = T_c = 25^\circ\text{C}$) (Continued)

Part Number	Nominal CCT ¹ (K)	CRI ²	Nominal Drive Current ³ (mA)	Typical Pulsed Flux ^{4,5,6} $T_c = 25^\circ\text{C}$ (lm)	Minimum Pulsed Flux ^{6,7} $T_c = 25^\circ\text{C}$ (lm)	Typical V_f (V)	Typical Power (W)	Typical Efficacy (lm/W)
BXRE-57Co801-D-8x	5700	70	300	942	829	16.8	5.0	187
BXRE-57Co801-E-8x	5700	70	150	942	829	33.5	5.0	188
BXRE-57E0801-D-8x	5700	80	300	895	788	16.8	5.0	178
BXRE-57E0801-E-8x	5700	80	150	895	788	33.5	5.0	178
BXRE-65Co801-D-8x	6500	70	300	942	829	16.8	5.0	187
BXRE-65Co801-E-8x	6500	70	150	942	829	33.5	5.0	188
BXRE-65E0801-D-8x	6500	80	300	906	797	16.8	5.0	180
BXRE-65E0801-E-8x	6500	80	150	906	797	33.5	5.0	180

Notes for Table 1:

1. Nominal CCT as defined by ANSI C78.377-2011.
2. CRI values are minimums and tested at $T_j = T_c = 25^\circ\text{C}$. Minimum Rg value for 80 CRI products is 0, the minimum Rg values for 90 CRI products is 50.
3. Drive current is referred to as nominal drive current.
4. Products tested under pulsed condition (10ms pulse width) at nominal test current where T_j (junction temperature) = T_c (case temperature) = 25°C .
5. Typical performance values are provided as a reference only and are not a guarantee of performance.
6. Bridgelux maintains a $\pm 7\%$ tolerance on flux measurements.
7. Minimum flux values at the nominal test current are guaranteed by 100% test.

Product Selection Guide

Table 2: Selection Guide, Stabilized DC Performance ($T_c = 85^\circ\text{C}$)

Part Number	Nominal CCT ¹ (K)	CRI ²	Nominal Drive Current ³ (mA)	Typical DC Flux ^{4,5} $T_c = 85^\circ\text{C}$ (lm)	Minimum DC Flux ⁶ $T_c = 85^\circ\text{C}$ (lm)	Typical V_f (V)	Typical Power (W)	Typical Efficacy (lm/W)
BXRE-27E0800-D-8x	2700	80	300	758	667	16.5	4.9	154
BXRE-27E0800-E-8x	2700	80	150	758	667	32.9	4.9	154
BXRE-27G0800-D-8x	2700	90	300	625	550	16.5	4.9	127
BXRE-27G0800-E-8x	2700	90	150	625	550	32.9	4.9	127
BXRE-27G08H0-D-8x	2700	90	300	652	574	16.5	4.9	132
BXRE-27G08H0-E-8x	2700	90	150	652	574	32.9	4.9	132
BXRE-27H0800-D-8x	2700	97	300	554	488	16.5	4.9	112
BXRE-27H0800-E-8x	2700	97	150	554	488	32.9	4.9	112
BXRE-30C0801-D-8x	3000	70	300	843	742	16.5	4.9	171
BXRE-30C0801-E-8x	3000	70	150	843	742	32.9	4.9	171
BXRE-30E0800-D-8x	3000	80	300	806	709	16.5	4.9	163
BXRE-30E0800-E-8x	3000	80	150	806	709	32.9	4.9	163
BXRE-30G0800-D-8x	3000	90	300	654	575	16.5	4.9	132
BXRE-30G0800-E-8x	3000	90	150	654	575	32.9	4.9	132
BXRE-30G08H0-D-8x	3000	90	300	685	603	16.5	4.9	139
BXRE-30G08H0-E-8x	3000	90	150	685	603	32.9	4.9	139
BXRE-30H0800-D-8x	3000	97	300	592	521	16.5	4.9	120
BXRE-30H0800-E-8x	3000	97	150	592	521	32.9	4.9	120
BXRE-35E0800-D-8x	3500	80	300	824	726	16.5	4.9	167
BXRE-35E0800-E-8x	3500	80	150	824	726	32.9	4.9	167
BXRE-35G0800-D-8x	3500	90	300	678	596	16.5	4.9	137
BXRE-35G0800-E-8x	3500	90	150	678	596	32.9	4.9	137
BXRE-40C0801-D-8x	4000	70	300	867	763	16.5	4.9	176
BXRE-40C0801-E-8x	4000	70	150	867	763	32.9	4.9	176
BXRE-40E0800-D-8x	4000	80	300	829	730	16.5	4.9	168
BXRE-40E0800-E-8x	4000	80	150	829	730	32.9	4.9	168
BXRE-40G0800-D-8x	4000	90	300	692	609	16.5	4.9	140
BXRE-40G0800-E-8x	4000	90	150	692	609	32.9	4.9	140
BXRE-50C0801-D-8x	5000	70	300	872	767	16.5	4.9	177
BXRE-50C0801-E-8x	5000	70	150	872	767	32.9	4.9	177
BXRE-50E0801-D-8x	5000	80	300	839	738	16.5	4.9	170
BXRE-50E0801-E-8x	5000	80	150	839	738	32.9	4.9	170
BXRE-50G0801-D-8x	5000	90	300	725	638	16.5	4.9	147
BXRE-50G0801-E-8x	5000	90	150	725	638	32.9	4.9	147

Notes for Table 2:

- Nominal CCT as defined by ANSI C78.377-2011.
- CRI values are minimums and tested at $T_j - T_c = 25^\circ\text{C}$. Minimum Rg value for 80 CRI products is 0, the minimum Rg values for 90 CRI products is 50.
- Drive current is referred to as nominal drive current.
- Typical stabilized DC performance values are provided as reference only and are not a guarantee of performance.
- Typical performance is estimated based on operation under DC (direct current) with LED array mounted onto a heat sink with thermal interface material and the case temperature maintained at 85°C . Based on Bridgelux test setup, values may vary depending on the thermal design of the luminaire and/or the exposed environment to which the product is subjected.
- Minimum flux values at elevated temperatures are provided for reference only and are not guaranteed by 100% production testing. Based on Bridgelux test setup, values may vary depending on the thermal design of the luminaire and/or the exposed environment to which the product is subjected.

Product Selection Guide

Table 2: Selection Guide, Stabilized DC Performance ($T_c = 85^\circ\text{C}$) (Continued)

Part Number	Nominal CCT ¹ (K)	CRI ²	Nominal Drive Current ³ (mA)	Typical DC Flux ^{4,5} $T_c = 85^\circ\text{C}$ (lm)	Minimum DC Flux ⁶ $T_c = 85^\circ\text{C}$ (lm)	Typical V_f (V)	Typical Power (W)	Typical Efficacy (lm/W)
BXRE-57Co801-D-8x	5700	70	300	848	746	16.5	4.9	172
BXRE-57Co801-E-8x	5700	70	150	848	746	32.9	4.9	172
BXRE-57Eo801-D-8x	5700	80	300	806	709	16.5	4.9	163
BXRE-57Eo801-E-8x	5700	80	150	806	709	32.9	4.9	163
BXRE-65Co801-D-8x	6500	70	300	848	746	16.5	4.9	172
BXRE-65Co801-E-8x	6500	70	150	848	746	32.9	4.9	172
BXRE-65Eo801-D-8x	6500	80	300	815	717	16.5	4.9	165
BXRE-65Eo801-E-8x	6500	80	150	815	717	32.9	4.9	165

Notes for Table 2:

- Nominal CCT as defined by ANSI C78.377-2011.
- CRI values are minimums and tested at $T_j = T_c = 25^\circ\text{C}$. Minimum Rg value for 80 CRI products is 0, the minimum Rg values for 90 CRI products is 50.
- Drive current is referred to as nominal drive current.
- Typical stabilized DC performance values are provided as reference only and are not a guarantee of performance.
- Typical performance is estimated based on operation under DC (direct current) with LED array mounted onto a heat sink with thermal interface material and the case temperature maintained at 85°C . Based on Bridgelux test setup, values may vary depending on the thermal design of the luminaire and/or the exposed environment to which the product is subjected.
- Minimum flux values at elevated temperatures are provided for reference only and are not guaranteed by 100% production testing. Based on Bridgelux test setup, values may vary depending on the thermal design of the luminaire and/or the exposed environment to which the product is subjected.

Performance at Commonly Used Drive Currents

V Series LED arrays are tested to the specifications shown using the nominal drive currents in Table 1. V Series may also be driven at other drive currents dependent on specific application design requirements. The performance at any drive current can be derived from the current vs. voltage characteristics shown in Figures 1 and 2 and the flux vs. current characteristics shown in Figures 3 and 4. The performance at commonly used drive currents is summarized in Table 3.

Table 3: Product Performance at Commonly Used Drive Currents

Part Number	CRI	Drive Current ¹ (mA)	Typical V_f $T_c = 25^\circ\text{C}$ (V)	Typical Power $T_c = 25^\circ\text{C}$ (W)	Typical Flux ² $T_c = 25^\circ\text{C}$ (lm)	Typical DC Flux ³ $T_c = 85^\circ\text{C}$ (lm)	Typical Efficacy $T_c = 25^\circ\text{C}$ (lm/W)
BXRE-27E0800-D-8x	80	150	16.3	2.4	438	395	180
		225	16.5	3.7	640	576	172
		300	16.8	5.0	842	758	167
		518	17.5	9.1	1385	1247	153
		718	18.1	13.0	1856	1670	143
		1000	18.9	18.9	2466	2219	131
BXRE-27E0800-E-8x	80	75	32.4	2.4	438	395	180
		110	33.0	3.6	627	564	173
		150	33.5	5.0	842	758	167
		175	33.9	5.9	966	870	163
		250	34.9	8.7	1342	1207	154
		500	37.7	18.8	2466	2219	131
BXRE-27G0800-D-8x	90	150	16.3	2.4	362	326	148
		225	16.5	3.7	528	475	142
		300	16.8	5.0	695	625	138
		518	17.5	9.1	1143	1029	126
		718	18.1	13.0	1531	1378	118
		1000	18.9	18.9	2034	1831	108
BXRE-27G0800-E-8x	90	75	32.4	2.4	362	326	149
		110	33.0	3.6	517	465	143
		150	33.5	5.0	695	625	138
		175	33.9	5.9	797	717	134
		250	34.9	8.7	1107	996	127
		500	37.7	18.8	2034	1831	108
BXRE-27G08H0-D-8x	90	150	16.3	2.4	377	340	155
		225	16.5	3.7	551	496	148
		300	16.8	5.0	725	652	144
		518	17.5	9.1	1192	1073	131
		718	18.1	13.0	1597	1437	123
		1000	18.9	18.9	2122	1910	112
BXRE-27G08H0-E-8x	90	75	32.4	2.4	377	340	155
		110	33.0	3.6	539	485	149
		150	33.5	5.0	725	652	144
		175	33.9	5.9	832	748	140
		250	34.9	8.7	1155	1039	132
		500	37.7	18.8	2122	1910	113

Notes for Table 3:

1. Alternate drive currents in Table 3 are provided for reference only and are not a guarantee of performance.
2. Bridgelux maintains a $\pm 7\%$ tolerance on flux measurements.
3. Typical stabilized DC performance values are provided as reference only and are not a guarantee of performance.

Performance at Commonly Used Drive Currents

Table 3: Product Performance at Commonly Used Drive Currents (continued)

Part Number	CRI	Drive Current ¹ (mA)	Typical V _f T _c = 25°C (V)	Typical Power T _c = 25°C (W)	Typical Flux ² T _c = 25°C (lm)	Typical DC Flux ³ T _c = 85°C (lm)	Typical Efficacy T _c = 25°C (lm/W)
BXRE-27H0800-D-8x	97	150	16.3	2.4	321	289	131
		225	16.5	3.7	468	421	126
		300	16.8	5.0	616	554	122
		518	17.5	9.1	1013	912	112
		718	18.1	13.0	1357	1221	104
		1000	18.9	18.9	1803	1623	95
BXRE-27H0800-E-8x	97	75	32.4	2.4	321	289	132
		110	33.0	3.6	458	412	126
		150	33.5	5.0	616	554	122
		175	33.9	5.9	707	636	119
		250	34.9	8.7	981	883	113
		500	37.7	18.8	1803	1623	96
BXRE-30C0801-D-8x	70	150	16.3	2.4	488	439	200
		225	16.5	3.7	712	641	191
		300	16.8	5.0	937	843	186
		518	17.5	9.1	1541	1387	170
		718	18.1	13.0	2065	1858	159
		1000	18.9	18.9	2743	2469	145
BXRE-30C0801-E-8x	70	75	32.4	2.4	488	439	200
		110	33.0	3.6	697	627	192
		150	33.5	5.0	937	843	186
		175	33.9	5.9	1075	967	181
		250	34.9	8.7	1492	1343	171
		500	37.7	18.8	2743	2469	146
BXRE-30E0800-D-8x	80	150	16.3	2.4	466	419	191
		225	16.5	3.7	680	612	183
		300	16.8	5.0	895	806	178
		518	17.5	9.1	1472	1325	162
		718	18.1	13.0	1972	1775	151
		1000	18.9	18.9	2620	2358	139
BXRE-30E0800-E-8x	80	75	32.4	2.4	466	419	191
		110	33.0	3.6	666	599	184
		150	33.5	5.0	895	806	178
		175	33.9	5.9	1027	924	173
		250	34.9	8.7	1425	1283	164
		500	37.7	18.8	2620	2358	139
BXRE-30G0800-D-8x	90	150	16.3	2.4	378	340	155
		225	16.5	3.7	552	497	148
		300	16.8	5.0	727	654	144
		518	17.5	9.1	1195	1075	132
		718	18.1	13.0	1601	1441	123
		1000	18.9	18.9	2127	1914	113

Notes for Table 3:

1. Alternate drive currents in Table 3 are provided for reference only and are not a guarantee of performance.
2. Bridgelux maintains a ± 7% tolerance on flux measurements.
3. Typical stabilized DC performance values are provided as reference only and are not a guarantee of performance.

Performance at Commonly Used Drive Currents

Table 3: Product Performance at Commonly Used Drive Currents (continued)

Part Number	CRI	Drive Current ¹ (mA)	Typical V _f T _c = 25°C (V)	Typical Power T _c = 25°C (W)	Typical Flux ² T _c = 25°C (lm)	Typical DC Flux ³ T _c = 85°C (lm)	Typical Efficacy T _c = 25°C (lm/W)
BXRE-30G0800-E-8x	90	75	32.4	2.4	378	340	155
		110	33.0	3.6	541	486	149
		150	33.5	5.0	727	654	144
		175	33.9	5.9	833	750	141
		250	34.9	8.7	1157	1041	133
		500	37.7	18.8	2127	1914	113
BXRE-30G08H0-D-8x	90	150	16.3	2.4	396	356	162
		225	16.5	3.7	578	520	155
		300	16.8	5.0	761	685	151
		518	17.5	9.1	1251	1126	138
		718	18.1	13.0	1676	1508	129
		1000	18.9	18.9	2227	2004	118
BXRE-30G08H0-E-8x	90	75	32.4	2.4	396	356	163
		110	33.0	3.6	566	509	156
		150	33.5	5.0	761	685	151
		175	33.9	5.9	873	785	147
		250	34.9	8.7	1212	1090	139
		500	37.7	18.8	2227	2004	118
BXRE-30H0800-D-8x	97	150	16.3	2.4	343	308	140
		225	16.5	3.7	500	450	134
		300	16.8	5.0	658	592	131
		518	17.5	9.1	1082	974	119
		718	18.1	13.0	1450	1305	111
		1000	18.9	18.9	1927	1734	102
BXRE-30H0800-E-8x	97	75	32.4	2.4	343	308	141
		110	33.0	3.6	490	441	135
		150	33.5	5.0	658	592	131
		175	33.9	5.9	755	679	127
		250	34.9	8.7	1048	943	120
		500	37.7	18.8	1927	1734	102
BXRE-35E0800-D-8x	80	150	16.3	2.4	477	429	196
		225	16.5	3.7	696	626	187
		300	16.8	5.0	916	824	182
		518	17.5	9.1	1507	1356	166
		718	18.1	13.0	2018	1816	155
		1000	18.9	18.9	2682	2414	142
BXRE-35E0800-E-8x	80	75	32.4	2.4	477	429	196
		110	33.0	3.6	682	613	188
		150	33.5	5.0	916	824	182
		175	33.9	5.9	1051	946	177
		250	34.9	8.7	1459	1313	167
		500	37.7	18.8	2682	2414	142

Notes for Table 3:

1. Alternate drive currents in Table 3 are provided for reference only and are not a guarantee of performance.
2. Bridgelux maintains a ± 7% tolerance on flux measurements.
3. Typical stabilized DC performance values are provided as reference only and are not a guarantee of performance.

Performance at Commonly Used Drive Currents

Table 3: Product Performance at Commonly Used Drive Currents (continued)

Part Number	CRI	Drive Current ¹ (mA)	Typical V _f T _c = 25°C (V)	Typical Power T _c = 25°C (W)	Typical Flux ² T _c = 25°C (lm)	Typical DC Flux ³ T _c = 85°C (lm)	Typical Efficacy T _c = 25°C (lm/W)
BXRE-35G0800-D-8x	90	150	16.3	2.4	392	353	161
		225	16.5	3.7	572	515	154
		300	16.8	5.0	753	678	149
		518	17.5	9.1	1238	1114	136
		718	18.1	13.0	1659	1493	127
		1000	18.9	18.9	2204	1984	117
BXRE-35G0800-E-8x	90	75	32.4	2.4	392	353	161
		110	33.0	3.6	560	504	154
		150	33.5	5.0	753	678	150
		175	33.9	5.9	864	777	146
		250	34.9	8.7	1199	1079	138
		500	37.7	18.8	2204	1984	117
BXRE-40C0801-D-8x	70	150	16.3	2.4	501	451	206
		225	16.5	3.7	732	659	197
		300	16.8	5.0	963	867	191
		518	17.5	9.1	1585	1426	175
		718	18.1	13.0	2123	1910	163
		1000	18.9	18.9	2820	2538	149
BXRE-40C0801-E-8x	70	75	32.4	2.4	501	451	206
		110	33.0	3.6	717	645	198
		150	33.5	5.0	963	867	192
		175	33.9	5.9	1105	995	186
		250	34.9	8.7	1534	1381	176
		500	37.7	18.8	2820	2538	150
BXRE-40E0800-D-8x	80	150	16.3	2.4	480	432	197
		225	16.5	3.7	700	630	188
		300	16.8	5.0	921	829	183
		518	17.5	9.1	1515	1364	167
		718	18.1	13.0	2030	1827	156
		1000	18.9	18.9	2697	2427	143
BXRE-40E0800-E-8x	80	75	32.4	2.4	480	432	197
		110	33.0	3.6	685	617	189
		150	33.5	5.0	921	829	183
		175	33.9	5.9	1057	951	178
		250	34.9	8.7	1467	1321	168
		500	37.7	18.8	2697	2427	143
BXRE-40G0800-D-8x	90	150	16.3	2.4	400	360	164
		225	16.5	3.7	584	526	157
		300	16.8	5.0	769	692	153
		518	17.5	9.1	1264	1138	139
		718	18.1	13.0	1693	1524	130
		1000	18.9	18.9	2250	2025	119

Notes for Table 3:

1. Alternate drive currents in Table 3 are provided for reference only and are not a guarantee of performance.
2. Bridgelux maintains a ± 7% tolerance on flux measurements.
3. Typical stabilized DC performance values are provided as reference only and are not a guarantee of performance.

Performance at Commonly Used Drive Currents

Table 3: Product Performance at Commonly Used Drive Currents (continued)

Part Number	CRI	Drive Current ¹ (mA)	Typical V _f T _c = 25°C (V)	Typical Power T _c = 25°C (W)	Typical Flux ² T _c = 25°C (lm)	Typical DC Flux ³ T _c = 85°C (lm)	Typical Efficacy T _c = 25°C (lm/W)
BXRE-40G0800-E-8x	90	75	32.4	2.4	400	360	164
		110	33.0	3.6	572	515	158
		150	33.5	5.0	769	692	153
		175	33.9	5.9	882	793	149
		250	34.9	8.7	1224	1102	140
		500	37.7	18.8	2250	2025	119
BXRE-50C0801-D-8x	70	150	16.3	2.4	504	454	207
		225	16.5	3.7	736	662	198
		300	16.8	5.0	969	872	192
		518	17.5	9.1	1593	1434	175
		718	18.1	13.0	2134	1921	164
		1000	18.9	18.9	2836	2552	150
BXRE-50C0801-E-8x	70	75	32.4	2.4	504	454	207
		110	33.0	3.6	721	649	199
		150	33.5	5.0	969	872	193
		175	33.9	5.9	1111	1000	187
		250	34.9	8.7	1543	1388	177
		500	37.7	18.8	2836	2552	150
BXRE-50E0801-D-8x	80	150	16.3	2.4	485	437	199
		225	16.5	3.7	708	637	190
		300	16.8	5.0	932	839	185
		518	17.5	9.1	1533	1379	169
		718	18.1	13.0	2053	1848	158
		1000	18.9	18.9	2728	2455	144
BXRE-50E0801-E-8x	80	75	32.4	2.4	485	437	199
		110	33.0	3.6	693	624	191
		150	33.5	5.0	932	839	185
		175	33.9	5.9	1069	962	180
		250	34.9	8.7	1484	1336	170
		500	37.7	18.8	2728	2455	145
BXRE-50G0801-D-8x	90	150	16.3	2.4	419	377	172
		225	16.5	3.7	612	551	165
		300	16.8	5.0	806	725	160
		518	17.5	9.1	1325	1192	146
		718	18.1	13.0	1775	1597	136
		1000	18.9	18.9	2358	2122	125
BXRE-50G0801-E-8x	90	75	32.4	2.4	419	377	172
		110	33.0	3.6	599	539	165
		150	33.5	5.0	806	725	160
		175	33.9	5.9	924	832	156
		250	34.9	8.7	1283	1155	147
		500	37.7	18.8	2358	2122	125

Notes for Table 3:

1. Alternate drive currents in Table 3 are provided for reference only and are not a guarantee of performance.
2. Bridgelux maintains a ± 7% tolerance on flux measurements.
3. Typical stabilized DC performance values are provided as reference only and are not a guarantee of performance.

Performance at Commonly Used Drive Currents

Table 3: Product Performance at Commonly Used Drive Currents (continued)

Part Number	CRI	Drive Current ¹ (mA)	Typical V _f T _c = 25°C (V)	Typical Power T _c = 25°C (W)	Typical Flux ² T _c = 25°C (lm)	Typical DC Flux ³ T _c = 85°C (lm)	Typical Efficacy T _c = 25°C (lm/W)
BXRE-57C0801-D-8x	70	150	16.3	2.4	491	441	201
		225	16.5	3.7	716	644	192
		300	16.8	5.0	942	848	187
		518	17.5	9.1	1550	1395	171
		718	18.1	13.0	2076	1868	159
		1000	18.9	18.9	2759	2483	146
BXRE-57C0801-E-8x	70	75	32.4	2.4	491	441	202
		110	33.0	3.6	701	631	193
		150	33.5	5.0	942	848	187
		175	33.9	5.9	1081	973	182
		250	34.9	8.7	1501	1351	172
		500	37.7	18.8	2759	2483	146
BXRE-57E0801-D-8x	80	150	16.3	2.4	466	419	191
		225	16.5	3.7	680	612	183
		300	16.8	5.0	895	806	178
		518	17.5	9.1	1472	1325	162
		718	18.1	13.0	1972	1775	151
		1000	18.9	18.9	2620	2358	139
BXRE-57E0801-E-8x	80	75	32.4	2.4	466	419	191
		110	33.0	3.6	666	599	184
		150	33.5	5.0	895	806	178
		175	33.9	5.9	1027	924	173
		250	34.9	8.7	1425	1283	164
		500	37.7	18.8	2620	2358	139
BXRE-65C0801-D-8x	70	150	16.3	2.4	491	441	201
		225	16.5	3.7	716	644	192
		300	16.8	5.0	942	848	187
		518	17.5	9.1	1550	1395	171
		718	18.1	13.0	2076	1868	159
		1000	18.9	18.9	2759	2483	146
BXRE-65C0801-E-8x	70	75	32.4	2.4	491	441	202
		110	33.0	3.6	701	631	193
		150	33.5	5.0	942	848	187
		175	33.9	5.9	1081	973	182
		250	34.9	8.7	1501	1351	172
		500	37.7	18.8	2759	2483	146
BXRE-65E0801-D-8x	80	150	16.3	2.4	471	424	193
		225	16.5	3.7	688	619	185
		300	16.8	5.0	906	815	180
		518	17.5	9.1	1489	1340	164
		718	18.1	13.0	1995	1795	153
		1000	18.9	18.9	2651	2386	140

Notes for Table 3:

1. Alternate drive currents in Table 3 are provided for reference only and are not a guarantee of performance.
2. Bridgelux maintains a ± 7% tolerance on flux measurements.
3. Typical stabilized DC performance values are provided as reference only and are not a guarantee of performance.

Performance at Commonly Used Drive Currents

Table 3: Product Performance at Commonly Used Drive Currents (continued)

Part Number	CRI	Drive Current ¹ (mA)	Typical V _f T _c = 25°C (V)	Typical Power T _c = 25°C (W)	Typical Flux ² T _c = 25°C (lm)	Typical DC Flux ³ T _c = 85°C (lm)	Typical Efficacy T _c = 25°C (lm/W)
BXRE-65E0801-E-8x	80	75	32.4	2.4	471	424	194
		110	33.0	3.6	674	606	186
		150	33.5	5.0	906	815	180
		175	33.9	5.9	1039	935	175
		250	34.9	8.7	1442	1298	165
		500	37.7	18.8	2651	2386	141

Notes for Table 3:

1. Alternate drive currents in Table 3 are provided for reference only and are not a guarantee of performance.
2. Bridgelux maintains a ± 7% tolerance on flux measurements.
3. Typical stabilized DC performance values are provided as reference only and are not a guarantee of performance.

Electrical Characteristics

Table 4: Electrical Characteristics

Part Number	Drive Current (mA)	Forward Voltage Pulsed, $T_c = 25^\circ\text{C}$ (V) ^{1, 2, 3, 8}			Typical Coefficient of Forward Voltage ⁴ $\Delta V_f / \Delta T_c$ (mV/ $^\circ\text{C}$)	Typical Thermal Resistance Junction to Case ^{5,6} R_{j-c} ($^\circ\text{C}/\text{W}$)	Driver Selection Voltages ⁷ (V)	
		Minimum	Typical	Maximum			V_f Min. Hot $T_c = 105^\circ\text{C}$ (V)	V_f Max. Cold $T_c = -40^\circ\text{C}$ (V)
BXRE-xxx080x-D-8x	300	15.5	16.8	18.1	-5.42	0.79	15.1	18.4
	1000	17.5	18.9	20.3	-6.10	1.13	17.0	20.7
BXRE-xxx080x-E-8x	150	31.0	33.5	36.0	-10.81	0.79	30.1	36.7
	500	34.9	37.7	40.5	-12.16	1.13	33.9	41.3

Notes for Table 4:

- Parts are tested in pulsed conditions, $T_c = 25^\circ\text{C}$. Pulse width is 10ms.
- Voltage minimum and maximum are provided for reference only and are not a guarantee of performance.
- Bridgelux maintains a tester tolerance of $\pm 0.10\text{V}$ on forward voltage measurements.
- Typical coefficient of forward voltage tolerance is $\pm 0.1\text{mV}$ for nominal current.
- Thermal resistance values are based from test data of a 3000K 80 CRI product.
- Thermal resistance value was calculated using total electrical input power; optical power was not subtracted from input power. The thermal interface material used during testing is not included in the thermal resistance value.
- V_f min hot and max cold values are provided as reference only and are not guaranteed by test. These values are provided to aid in driver design and selection over the operating range of the product.
- This product has been designed and manufactured per IEC 62031:2018. This product has passed dielectric withstand voltage testing at 1140 V. The working voltage designated for the insulation is 70V d.c. The maximum allowable voltage across the array must be determined in the end product application.

Eye Safety

Table 5: Eye Safety Risk Group (RG) Classifications

Part Number	Drive Current (mA)	CCT ⁴			
		2700K/3000K	4000K	5000K ²	6500K ³
BXRE-xxx080x-D-8x	515	RG1	RG1	RG1	RG1
	715	RG1	RG1	RG1	RG2
	1000	RG1	RG1	RG2	RG2
BXRE-xxx080x-E-8x	260	RG1	RG1	RG1	RG1
	360	RG1	RG1	RG1	RG2
	500	RG1	RG1	RG2	RG2

Notes for Table 5:

1. Eye safety classification for the use of Bridgelux V Series LED arrays is in accordance with specification IEC/TR 62778: Application of IEC 62471 for the assessment of blue light hazard to light sources and luminaires.
2. For products classified as RG2 at 5000K Ethr= 1530 lx.
3. For products classified as RG2 at 6500K, Ethr= 1170 lx.
4. Please contact your Bridgelux sales representative for Ethr values at specific drive currents and CCTs not listed.

Absolute Maximum Ratings

Table 6: Maximum Ratings

Parameter	Maximum Rating	
LED Junction Temperature (T_j)	150°C	
Storage Temperature	-40°C to +105°C	
Operating Case Temperature ¹ (T_c)	105°C	
Soldering Temperature ²	300°C or lower for a maximum of 6 seconds	
	BXRE-xxx080x-D-8x	BXRE-xxx080x-E-8x
Maximum Drive Current ³	1000 mA	500 mA
Maximum Peak Pulsed Drive Current ⁴	1120 mA	560 mA
Maximum Reverse Voltage ⁵	-30V	-60V

Notes for Table 6:

1. For IEC 62717 requirement, please consult your Bridgelux sales representative.
2. Refer to Bridgelux Application Note AN101: Handling and Assembly of Bridgelux V Series LED Arrays.
3. Arrays may be driven at higher currents however lumen maintenance may be reduced and warranty will not apply.
4. Bridgelux recommends a maximum duty cycle of 10% and pulse width of 20 ms when operating LED Arrays at maximum peak pulsed current specified. Maximum peak pulsed currents indicate values where LED Arrays can be driven without catastrophic failures.
5. Light emitting diodes are not designed to be driven in reverse voltage and will not produce light under this condition. Maximum rating provided for reference only.

Performance Curves

Figure 1: V8D Drive Current vs. Voltage ($T_j = T_c = 25^\circ\text{C}$)¹

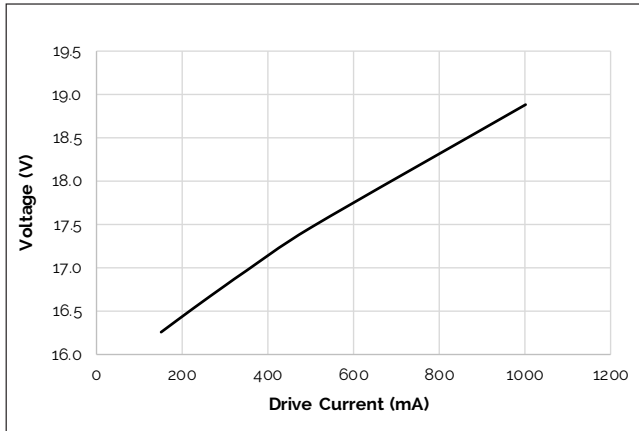

Figure 2: V8E Drive Current vs. Voltage ($T_j = T_c = 25^\circ\text{C}$)¹

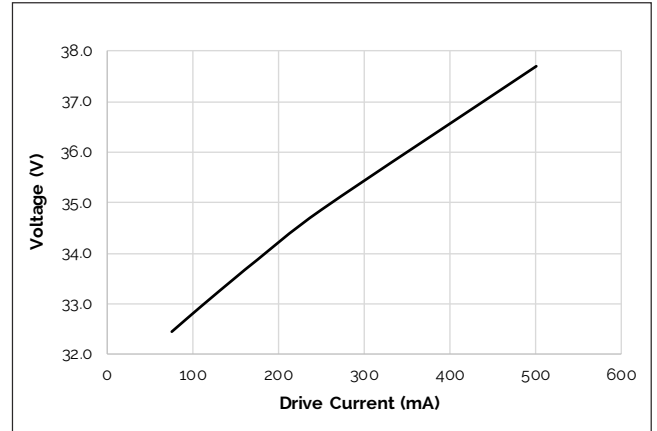

Figure 3: V8D Typical Relative Luminous Flux vs. Drive Current ($T_j = T_c = 25^\circ\text{C}$)¹

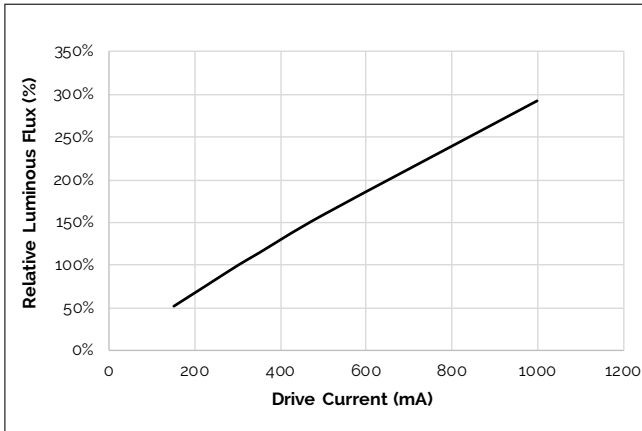
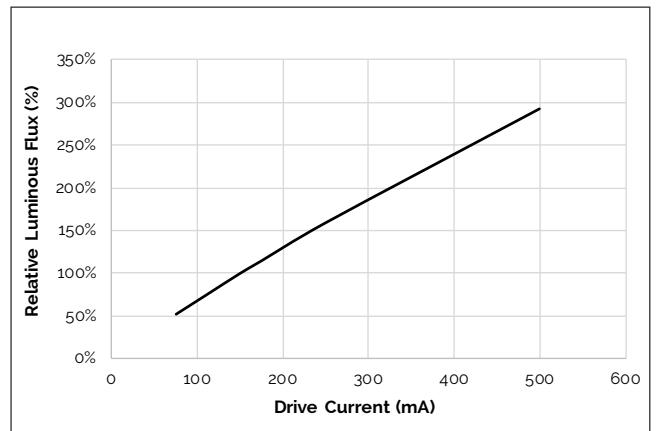

Figure 4: V8E Typical Relative Luminous Flux vs. Drive Current ($T_j = T_c = 25^\circ\text{C}$)¹



Notes for Figures 1 - 4:

1. Bridgelux does not recommend driving high power LEDs at low currents. Doing so may produce unpredictable results. Pulse width modulation (PWM) is recommended for dimming effects.
2. Characteristics shown for 3000K and 90 CRI.

Performance Curves

Figure 5: Typical DC Flux vs. Case Temperature

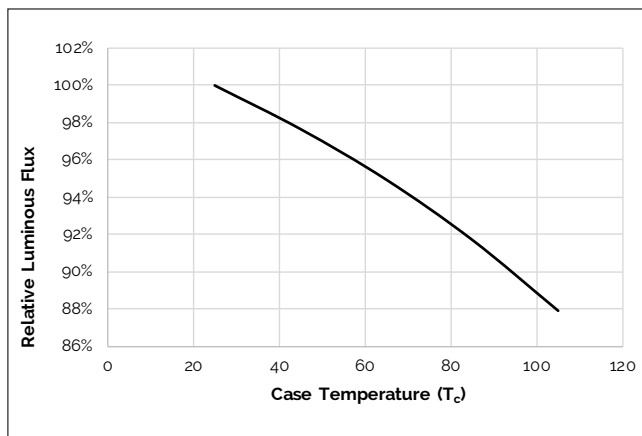

Figure 6: Typical DC ccx Shift vs. Case Temperature

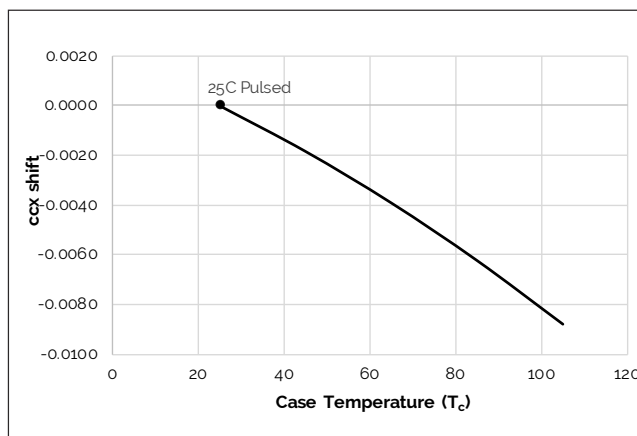
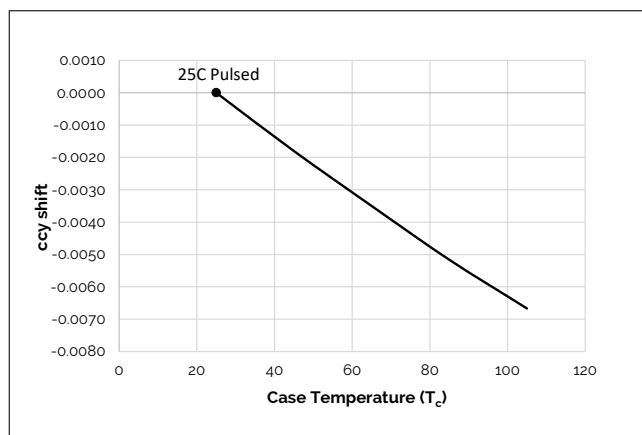

Figure 7: Typical DC ccy Shift vs. Case Temperature



Note for Figures 5-7:

1. Characteristics shown for warm White.

Typical Color Spectrum

Figure 8: Typical Color Spectrum

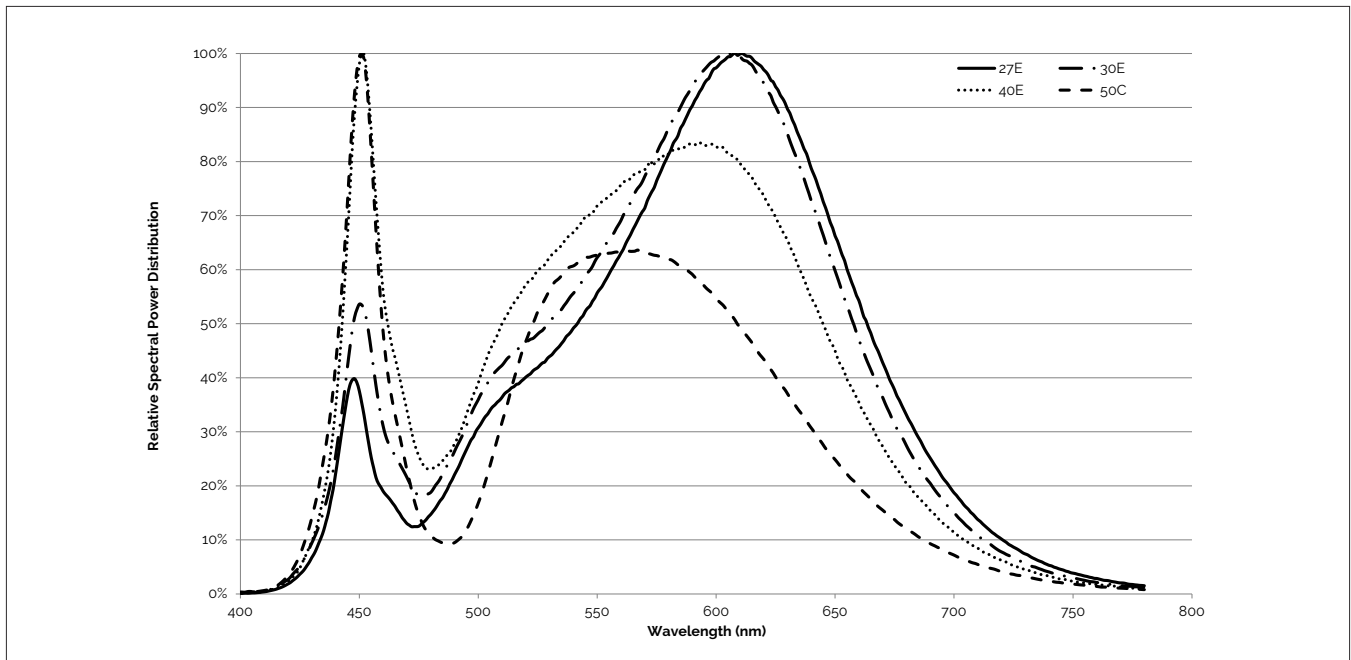

Notes for Figure 8:

1. Color spectra measured at nominal current for $T_j = T_c = 25^\circ\text{C}$.
2. Color spectra shown is 2700K and 80 CRI.
3. Color spectra shown is 3000K and 80 CRI.
4. Color spectra shown is 4000K and 80 CRI.
5. Color spectra shown is 5000K and 70 CRI.

Typical Radiation Pattern

Figure 9: Typical Spatial Radiation Pattern

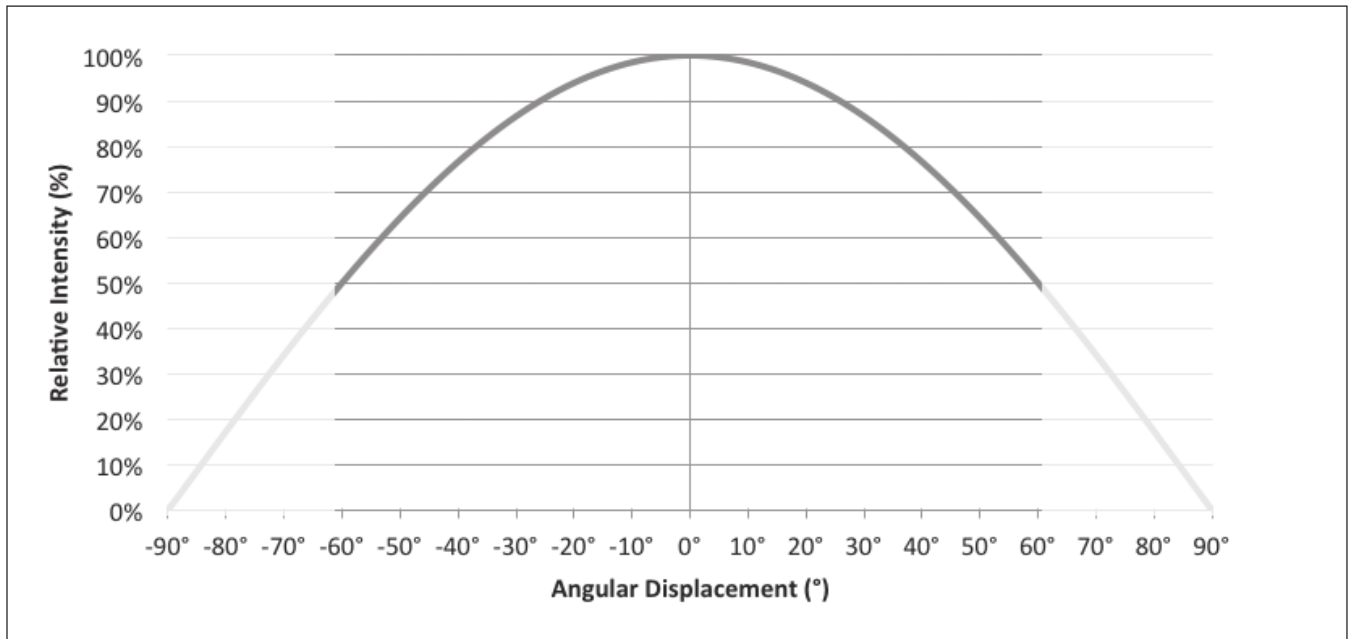

Notes for Figure 9:

1. Typical viewing angle is 120°.
2. The viewing angle is defined as the off axis angle from the centerline where intensity is ½ of the peak value.

Figure 10: Typical Polar Radiation Pattern

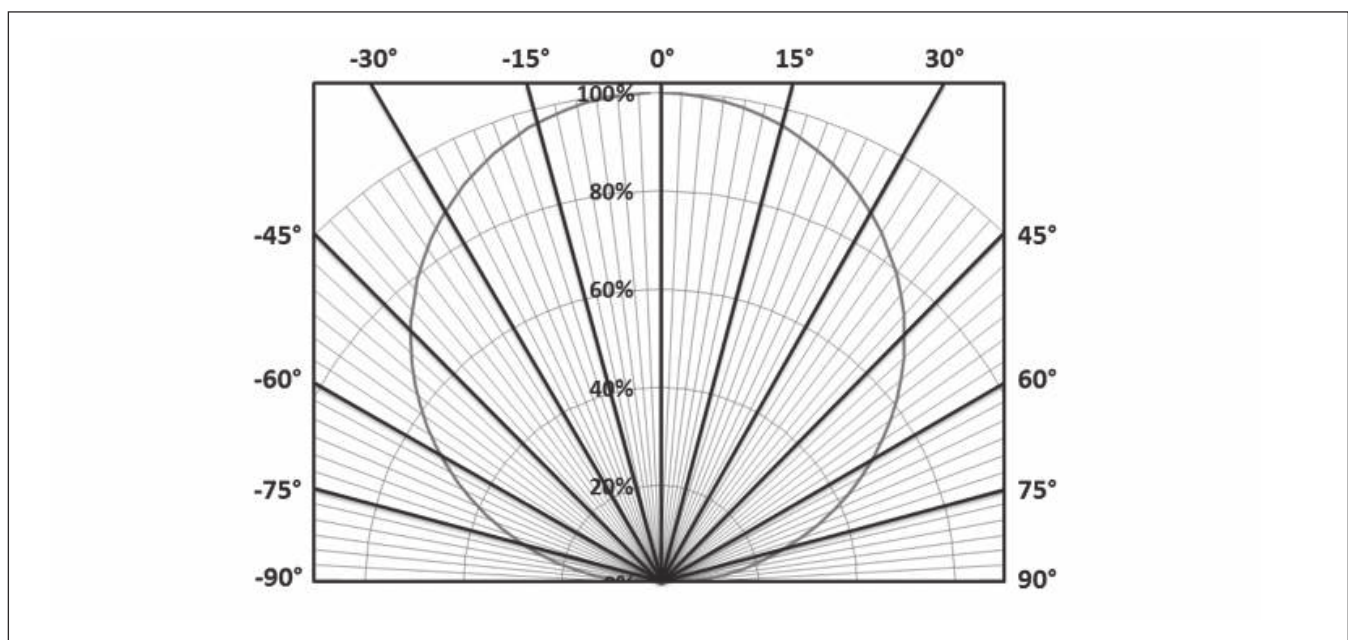

Mechanical Dimensions

Figure 11: V8 LED Array

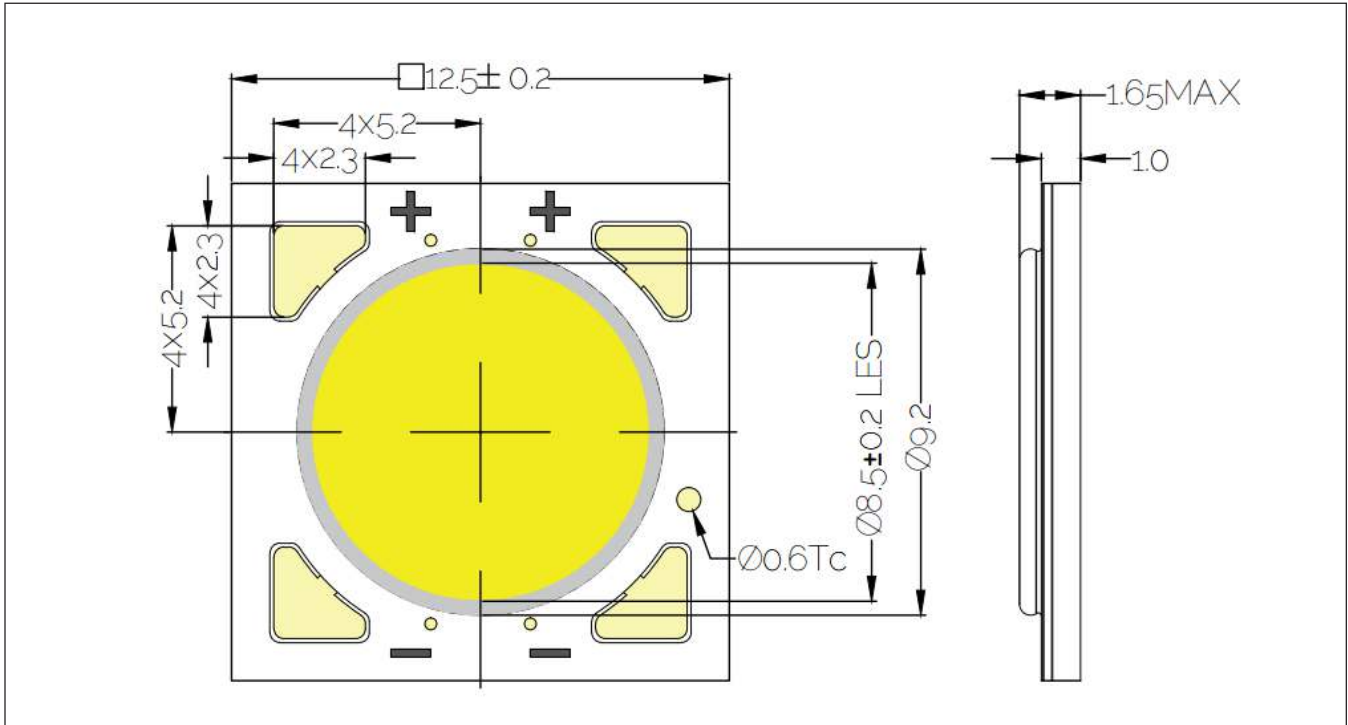

Notes for Figure 11:

1. Drawings are not to scale.
2. Drawing dimensions are in millimeters.
3. Solder pads are labeled "+" and "-" to denote positive and negative polarity, respectively.
4. Unless otherwise specified, tolerances are ± 0.1 mm.
5. Refer to Application Notes AN101 for product handling, mounting and heat sink recommendations.
6. The optical center of the LED Array is nominally defined by the mechanical center of the array to a tolerance of ± 0.2 mm.
7. Bridgelux maintains a flatness of 0.10 mm across the mounting surface of the array.

Color Binning Information

Figure 12: Graph of Warm and Neutral White Test Bins in xy Color Space

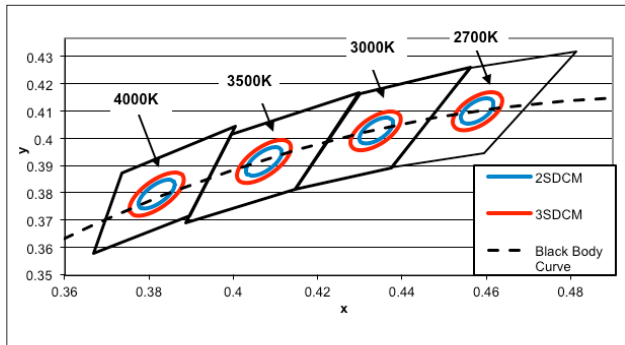

Note: Pulsed Test Conditions, $T_c = 25^\circ\text{C}$

Figure 13: Graph of Cool White Test Bins in xy Color Space

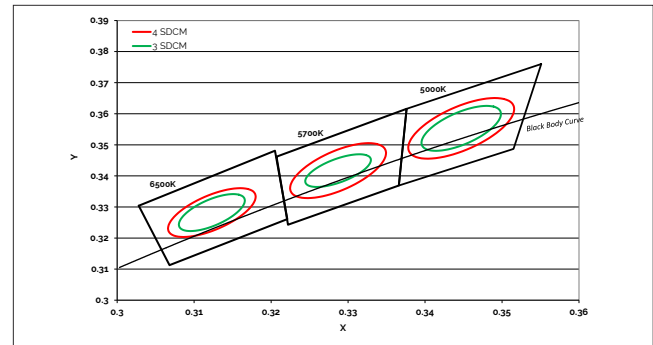

Note: Pulsed Test Conditions, $T_c = 25^\circ\text{C}$

Table 7: Warm and Neutral White xy Bin Coordinates and Associated Typical CCT

Bin Code	2700K	3000K	3500K	4000K
ANSI Bin (for reference only)	(2580K - 2870K)	(2870K - 3220K)	(3220K - 3710K)	(3710K - 4260K)
82 (2 SDCM)	(2674K - 2769K)	(2995K - 3107K)	(3404K - 3548K)	(3895K - 4081K)
83 (3 SDCM)	(2651K - 2794K)	(2968K - 3136K)	(3369K - 3586K)	(3851K - 4130K)
Center Point (x,y)	(0.4578, 0.4101)	(0.4338, 0.403)	(0.4073, 0.3917)	(0.3818, 0.3797)

Table 8: Cool White xy Bin Coordinates and Associated Typical CCT (product is hot targeted to $T_c = 85^\circ\text{C}$)

Bin Code	5000K	5700K	6500K
ANSI Bin (for reference only)	(4745K - 5311K)	(5312K - 6022K)	(6022K - 7042K)
84 (4 SDCM)	(4801K - 5282K)	(5395K - 5970K)	(6200K - 6910K)
83 (3 SDCM)	(4835K - 5215K)	(5460K - 5891K)	(6279K - 6811K)
Center Point (x,y)	(0.3447, 0.3553)	(0.3287, 0.3417)	(0.3123, 0.3282)

Note for Tables 7-8:

1. Bridgelux maintains a tolerance of +/- 0.007 on x and y color coordinates in the CIE 1931 color Space.

Packaging and Labeling

Figure 14: Drawing for V8 Packaging Tube



Notes for Figure 14:

1. Each tube holds 40 V8 COB arrays.
2. One tube is sealed in an anti-static bag. Four bags are placed in a shipping box. Depending on quantities ordered, a bigger shipping box, containing four boxes may be used to ship products.
3. Each bag and box is to be labeled as shown above.
4. Dimensions for each tube are 8.3mm (W) x 14.3mm (H) x 530mm (L). Dimensions for the anti-static bag are 75 (W) x 615 (L) x 31 (T) mm. Dimensions for the shipping box are 58.7 x 133 x 7.9 cm

Packaging and Labeling

Figure 15: Gen. 8 Product Labeling

Bridgelux COB arrays have laser markings on the back side of the substrate to help with product identification. In addition to the product identification markings, Bridgelux COB arrays also contain markings for internal Bridgelux manufacturing use only. The image below shows which markings are for customer use and which ones are for Bridgelux internal use only. The Bridgelux internal manufacturing markings are subject to change without notice, however these will not impact the form, function or performance of the COB array.



Design Resources

Application Notes

Bridgelux has developed a comprehensive set of application notes and design resources to assist customers in successfully designing with the V Series product family of LED array products. For all available application notes visit www.bridgelux.com.

Optical Source Models

Optical source models and ray set files are available for all Bridgelux products. Please contact your Bridgelux Sales Representative for more information.

3D CAD Models

Three dimensional CAD models depicting the product outline of all Bridgelux V Series LED arrays are available in both IGS and STEP formats. Please contact your Bridgelux sales representative for assistance.

LM80

LM80 testing has been completed and the LM80 report is now available. Please contact your Bridgelux sales representatives for LM-80 report.

Precautions

CAUTION: CHEMICAL EXPOSURE HAZARD

Exposure to some chemicals commonly used in luminaire manufacturing and assembly can cause damage to the LED array. Please consult Bridgelux Application Note AN101 for additional information.

CAUTION: RISK OF BURN

Do not touch the V Series LED array during operation. Allow the array to cool for a sufficient period of time before handling. The V Series LED array may reach elevated temperatures such that could burn skin when touched

CAUTION

CONTACT WITH LIGHT EMITTING SURFACE (LES)

Avoid any contact with the LES. Do not touch the LES of the LED array or apply stress to the LES (yellow phosphor resin area). Contact may cause damage to the LED array.

Optics and reflectors must not be mounted in contact with the LES (yellow phosphor resin area). Use the mechanical features of the LED array housing and/or edges to locate and secure optical devices as needed.

Disclaimers

MINOR PRODUCT CHANGE POLICY

The rigorous qualification testing on products offered by Bridgelux provides performance assurance. Slight cosmetic changes that do not affect form, fit, or function may occur as Bridgelux continues product optimization.

STANDARD TEST CONDITIONS

Unless otherwise stated, array testing is performed at the nominal drive current.

About Bridgelux: Bridging Light and Life™

At Bridgelux, we help companies, industries and people experience the power and possibility of light. Since 2002, we've designed LED solutions that are high performing, energy efficient, cost effective and easy to integrate. Our focus is on light's impact on human behavior, delivering products that create better environments, experiences and returns—both experiential and financial. And our patented technology drives new platforms for commercial and industrial luminaires.

For more information about the company, please visit
bridgelux.com
twitter.com/Bridgelux
facebook.com/Bridgelux
youtube.com/user/Bridgelux
linkedin.com/company/bridgelux-inc-_2
WeChat ID: BridgeluxInChina



46430 Fremont Boulevard
Fremont, CA 94538 USA
Tel (925) 583-8400
www.bridgelux.com

© 2021 Bridgelux, Inc. All rights reserved. Product specifications are subject to change without notice. Bridgelux, the Bridgelux stylized logo design and Vero are registered trademarks. V Series and Decor Series are trademarks of Bridgelux, Inc. All other trademarks are the property of their respective owners.

Bridgelux Gen 8 V8 Array Series Product Data Sheet DS411 Rev. B (06/2021)