

REVISIONS				
EC NO	DATE	REV	DESCRIPTION	CHANGER
CY11-6913	2011/06/30	B	UPDATE DESCRIPTION OF 687670031 CHANGE BOM ONLY FOR PN 687670031	JLIU13

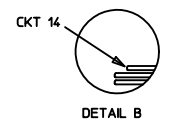
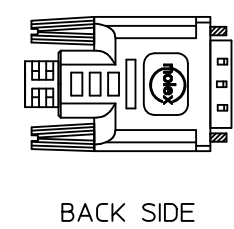
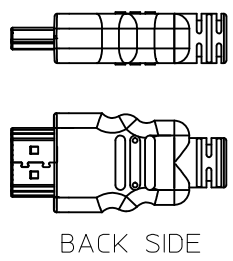
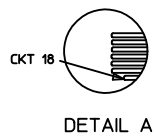
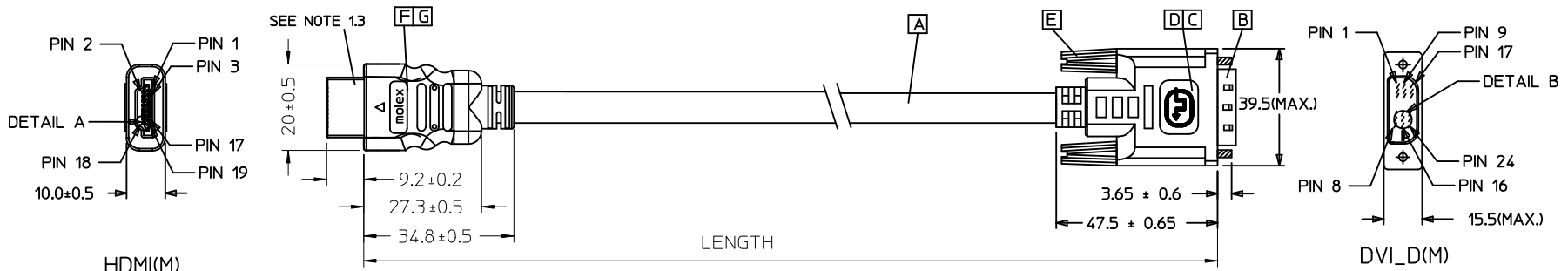

MX P/N	DESCRIPTION	LENGTH	CABLE COLOR	CABLE OD
687670031	HDMI (M) TO DVI-D(M) 5M CABLE 28#AWG	5000 ± 100	BLACK	7.3MM(ITMDS - AWG#28)
687670030	HDMI TO DVI-D(M) GOLD 3M CABLE	3000 ± 50	BLACK	7.3MM(ITMDS - AWG#28)
687670029	HDMI TO DVI-D(M) GOLD 2M CABLE	2000 ± 30	BLACK	7.3MM(ITMDS - AWG#28)
687670028	HDMI TO DVI-D(M) GOLD 1M CABLE	1000 ± 30	BLACK	7.3MM(ITMDS - AWG#28)

ENTER DESCRIPTION	QUALITY SYMBOLS
EC NO: DG2012-0060	▽=0
DRWN:FZHANG01 2011/07/21	∇=0
CHKD:JLIU13 2011/07/21	
APPR:ZXDENG 2011/07/22	
REV	DESCRIPTION
B	

GENERAL TOLERANCES (UNLESS SPECIFIED)	
	mm INCH
4 PLACES	± --- ± ---
3 PLACES	± --- ± ---
2 PLACES	± --- ± ---
1 PLACE	± --- ± ---
ANGULAR ± ---°	
DRAFT WHERE APPLICABLE MUST REMAIN WITHIN DIMENSIONS	

DIMENSION STYLE	
MM ONLY	
DRAWN BY	DATE
FZHANG01	2011/05/06
CHECKED BY	DATE
JFZHENG	2011/05/06
APPROVED BY	DATE
ZXDENG	2011/07/22
MATERIAL NO.	
687670028/29/30/31	
SIZE	
A 4	

SCALE	DESIGN UNITS	THIRD ANGLE PROJECTION
---	METRIC	
TITLE		
HDMI(M) TO DVI-D(M) CABLE ASS'Y		
MOLEX INCORPORATED		
DOCUMENT NO.	SHEET NO.	
SD-68767-0028-0031	1 OF 2	

- NOTE:
- OVEMROLD SPECIFICATION:
 - DVI BOOT MOLDED SNOW WHITE PVC RESIN ,UL94V-0.
 - HDMI INNERMOLD WITH BK PVC
HDMI OVERMOLD WITH PVC
 - HDMI DUST COVER WITH PE
 - PRODUCT ELECTRICAL SPECIFICATION:
REFER TO HDMI ELECTRICAL SPECIFICATION FOR DETAILS.
 - DVI CONNECTOR SPECIFICATION:
 - REFER TO PRODUCT SPEC. PS74320-001
 - CONTACT PLATING: AU FLASH.
 - THIS PRODUCT MUST MEET THE EU RoHS CHEMICAL SUBSTANCES SPECIFICATION FOR PRODUCTS (EU 2002/95/EC).

SHIELD	SHIELD	OVERALL SHIELD	GROUND
PIN 19	PIN 16	WHITE	HOT PLUG DETECT
PIN 18	PIN 14	YELLOW	POWER +5V
PIN 17	PIN 15	ORANGE	GROUND(+5V&DDC)
PIN 16	PIN 7	RED	DDC DATA(SDA)
PIN 15	PIN 6	VIOLET	DDC CLOCK(SCL)
PIN 12	PIN 24	WHITE	TMDS CLOCK-
PIN 11	PIN 22	BRAID	TMDS CLOCK SHIELD
PIN 10	PIN 23	BROWN	TMDS CLOCK+
PIN 9	PIN 17	WHITE	TMDS DATA 0-
PIN 8	PIN 19	BRAID	TMDS DATA 0 SHIELD
PIN 7	PIN 18	BLUE	TMDS DATA 0+
PIN 6	PIN 9	WHITE	TMDS DATA 1-
PIN 5	PIN 11	BRAID	TMDS DATA 1 SHIELD
PIN 4	PIN 10	GREEN	TMDS DATA 1+
PIN 3	PIN 1	WHITE	TMDS DATA 2-
PIN 2	PIN 3	BRAID	TMDS DATA 2 SHIELD
PIN 1	PIN 2	RED	TMDS DATA 2+
HDMI	DVI-D	COLOR	CABLE FUNCTION

ITEM	DESCRIPTION	QTY.
G	Metal Shell For HDMI 19P Male (Only for 687670031)	1
	Metal Shell For HDMI 19P Male,Gold flash (Only for 687670028-30)	1
F	HDMI 19P MALE,30U"Au Solder Type	1
E	DVI THUMB SCREW GOLD PLATED.	2
D	PCB	1
C	ONE BODY CAN	1
B	DVI-D Au flash sub-Assy (Only for 687670031)	1
	DVI_D SINGLE CHANNEL G/F CONNECTOR (Only for 687670028-30)	1
A	(4P+1P+3C)28,SHLD,PVC,BK;7.30,UL20276DVI	1

ENTER DESCRIPTION EC NO: DG2012-0060 DRWN:FZHANG01 CHKD:JLU13 APPR:ZXDENG	2011/07/21 2011/07/21 2011/07/22	DESCRIPTION B	QUALITY SYMBOLS ▽=0 ▽=0	GENERAL TOLERANCES (UNLESS SPECIFIED)		DIMENSION STYLE MM ONLY		SCALE ---	DESIGN UNITS METRIC	THIRD ANGLE PROJECTION 	
					mm	INCH	DRAWN BY FZHANG01	DATE 2011/05/06	TITLE HDMI(M) TO DVI-D(M) CABLE ASS'Y		
				4 PLACES	± ---	± ---	CHECKED BY JFZHENG	DATE 2011/05/06			
				3 PLACES	± ---	± ---	APPROVED BY ZXDENG	DATE 2011/07/22			
2 PLACES	± ---	± ---	MATERIAL NO. 687670028/29/30/31								
1 PLACE	± ---	± ---	ANGULAR ±---°		DOCUMENT NO. SD-68767-0028-0031		SHEET NO. 2 OF 2				
DRAFT WHERE APPLICABLE MUST REMAIN WITHIN DIMENSIONS				THIS DRAWING CONTAINS INFORMATION THAT IS PROPRIETARY TO MOLEX INCORPORATED AND SHOULD NOT BE USED WITHOUT WRITTEN PERMISSION							

7 6 5 4 3 2 1

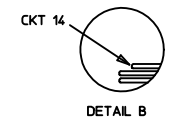
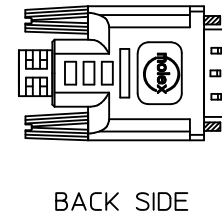
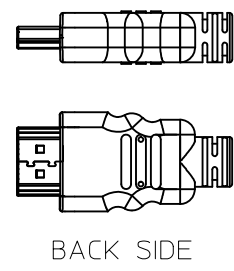
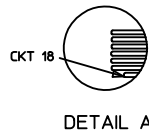
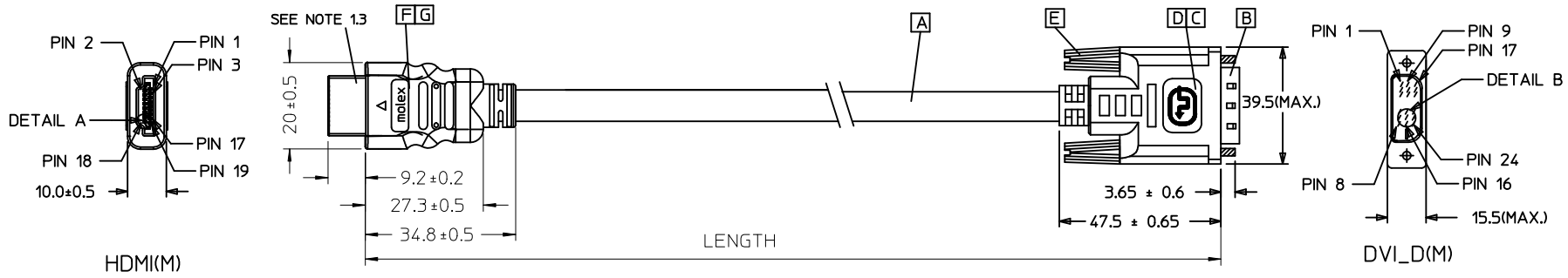

687670031	HDMI TO DVI-D(M) GOLD 5M CABLE	5000 ± 100	BLACK	7.3MM(TMDS - AWG#28)
687670030	HDMI TO DVI-D(M) GOLD 3M CABLE	3000 ± 50	BLACK	7.3MM(TMDS - AWG#28)
687670029	HDMI TO DVI-D(M) GOLD 2M CABLE	2000 ± 30	BLACK	7.3MM(TMDS - AWG#28)
687670028	HDMI TO DVI-D(M) GOLD 1M CABLE	1000 ± 30	BLACK	7.3MM(TMDS - AWG#28)
MX P/N	DESCRIPTION	LENGTH	CABLE COLOR	CABLE OD

ENTER DESCRIPTION EC NO: DG2011-0446 DRWN:FZHANG01 CHKD:PH ZHU APPR:ZXDENG	2011/05/06 2011/05/06 2011/05/11	DESCRIPTION A	QUALITY SYMBOLS ▽=0 ◻=0	GENERAL TOLERANCES (UNLESS SPECIFIED)		DIMENSION STYLE MM ONLY		SCALE ----	DESIGN UNITS METRIC	THIRD ANGLE PROJECTION			
				4 PLACES	± ---	± ---	mm	INCH	DRAWN BY FZHANG01	DATE 2011/05/06	TITLE HDMI(M) TO DVI-D(M) CABLE ASS'Y		
				3 PLACES	± ---	± ---			CHECKED BY JFZHENG	DATE 2011/05/06			
				2 PLACES	± ---	± ---			APPROVED BY ZXDENG	DATE 2011/05/11	MOLEX INCORPORATED DOCUMENT NO. SD-68767-00XX SHEET NO. 1 OF 2		
				1 PLACE	± ---	± ---			MATERIAL NO. 6876700XX				
DRAFT WHERE APPLICABLE MUST REMAIN WITHIN DIMENSIONS				ANGULAR ± ---°		THIS DRAWING CONTAINS INFORMATION THAT IS PROPRIETARY TO MOLEX INCORPORATED AND SHOULD NOT BE USED WITHOUT WRITTEN PERMISSION							

6 5 4 3 2 1

7

6

5

4

3

2

1

NOTE:

1. OVERMOLD SPECIFICATION:

1.1 DVI BOOT MOLDED SNOW WHITE PVC RESIN

1.2 HDMI INNERMOLD WITH BK PVC

HDMI OVERMOLD WITH PVC

1.3 HDMI DUST COVER WITH PE

2. PRODUCT ELECTRICAL SPECIFICATION:

REFER TO HDMI SPECIFICATION

3. DVI CONNECTOR SPECIFICATION

3.1 REFER TO PRODUCT SPEC. PS74320-00



3.2 CONTACT PLATING: AU FLASH.

4. THIS PRODUCT MUST MEET THE EU RoHS CHEMICAL SUBSTANCES SPECIFICATION FOR PRODUCTS (EU 2002/95/EC).

SHIELD	SHIELD	OVERALL SHIELD	GROUND
PIN 19	PIN 16	WHITE	HOT PLUG DETECT
PIN 18	PIN 14	YELLOW	POWER +5V
PIN 17	PIN 15	ORANGE	GROUND(+5V&DDC)
PIN 16	PIN 7	RED	DDC DATA(SDA)
PIN 15	PIN 6	VIOLET	DDC CLOCK(SCL)
PIN 12	PIN 24	WHITE	TMDS CLOCK-
PIN 11	PIN 22	BRAID	TMDS CLOCK SHIELD
PIN 10	PIN 23	BROWN	TMDS CLOCK+
PIN 9	PIN 17	WHITE	TMDS DATA 0-
PIN 8	PIN 19	BRAID	TMDS DATA 0 SHIELD
PIN 7	PIN 18	BLUE	TMDS DATA 0+
PIN 6	PIN 9	WHITE	TMDS DATA 1-
PIN 5	PIN 11	BRAID	TMDS DATA 1 SHIELD
PIN 4	PIN 10	GREEN	TMDS DATA 1+
PIN 3	PIN 1	WHITE	TMDS DATA 2-
PIN 2	PIN 3	BRAID	TMDS DATA 2 SHIELD
PIN 1	PIN 2	RED	TMDS DATA 2+
HDMI	DVI-D	COLOR	CABLE FUNCTION

G	Metal Shell For HDMI 19P Male,Gold flash	1
F	HDMI 19P MALE,30U"Au Solder Type	1
E	DVI THUMB SCREW GOLD PLATED.	2
D	PCB	1
C	ONE BODY CAN	1
B	DVI_D SINGLE CHANNEL G/F CONNECTOR	1
A	(4P+1P+3C)28,SHLD,PVC,BK,7.30,UL20276DVI	1
ITEM	DESCRIPTION	QTY.

ENTER DESCRIPTION
 EC NO: DG2011-0446
 DRWN:FZHANG01 2011/05/06
 CHKD:PH ZHU 2011/05/06
 APPR:ZXDENG 2011/05/11

QUALITY SYMBOLS
 =0
 =0

GENERAL TOLERANCES (UNLESS SPECIFIED)

	mm	INCH
4 PLACES	± ---	± ---
3 PLACES	± ---	± ---
2 PLACES	± ---	± ---
1 PLACE	± ---	± ---
ANGULAR ± ---°		

DRAFT WHERE APPLICABLE
MUST REMAIN
WITHIN DIMENSIONS

DIMENSION STYLE
MM ONLY

DRAWN BY	DATE
FZHANG01	2011/05/06
CHECKED BY	DATE
JFZHENG	2011/05/06
APPROVED BY	DATE
ZXDENG	2011/05/11

MATERIAL NO.
6876700XX

SCALE

DESIGN UNITS
METRIC

THIRD ANGLE PROJECTION

TITLE
HDMI(M) TO DVI-D(M)
CABLE ASS'Y

 MOLEX INCORPORATED

DOCUMENT NO.
SD-68767-00XX

SHEET NO.
2 OF 2

THIS DRAWING CONTAINS INFORMATION THAT IS PROPRIETARY TO MOLEX INCORPORATED AND SHOULD NOT BE USED WITHOUT WRITTEN PERMISSION

6

5

4

3

2

1

7 6 5 4 3 2 1

E

E

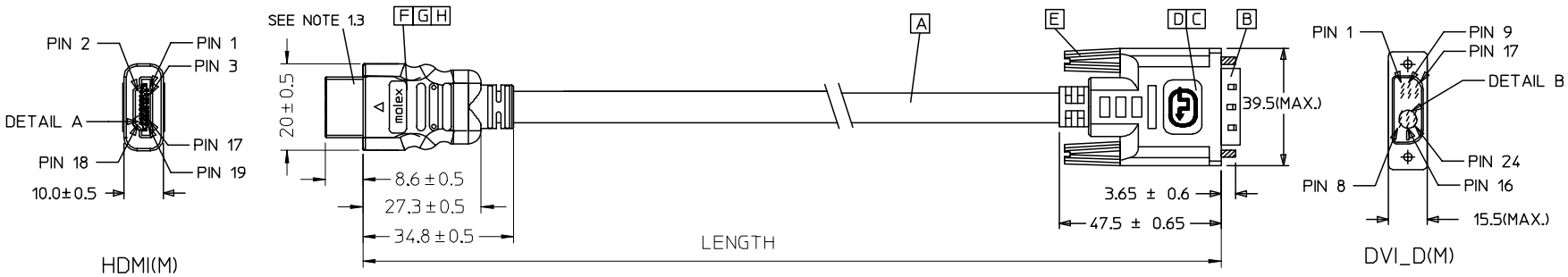

D

D

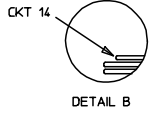
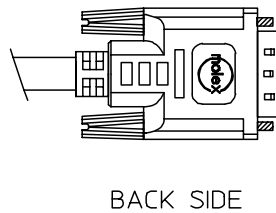
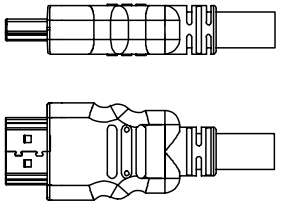
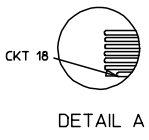

C

C

B

B

68767-0031	HDMI TO DVI-D(M) GOLD 5M CABLE	5000 ± 100	BLACK	7.3MM(TMDS - AWG#28)	887808276
68767-0030	HDMI TO DVI-D(M) GOLD 3M CABLE	3000 ± 50	BLACK	7.3MM(TMDS - AWG#28)	887808276
68767-0029	HDMI TO DVI-D(M) GOLD 2M CABLE	2000 ± 30	BLACK	7.3MM(TMDS - AWG#28)	887808276
68767-0028	HDMI TO DVI-D(M) GOLD 1M CABLE	1000 ± 30	BLACK	7.3MM(TMDS - AWG#28)	887808276
MX P/N	DESCRIPTION	LENGTH	CABLE COLOR	CABLE OD	CABLE P/N

A

A

Released EC NO: DG2007-0029 DRWN: JFZHENG 2006/09/08 CHKD: JFZHENG 2006/09/08 APPR: DQLUO 2006/09/11	QUALITY SYMBOLS ▽=0 ◻=0	GENERAL TOLERANCES (UNLESS SPECIFIED) <table border="1"> <tr> <td></td> <td>mm</td> <td>INCH</td> </tr> <tr> <td>4 PLACES</td> <td>± ---</td> <td>± ---</td> </tr> <tr> <td>3 PLACES</td> <td>± ---</td> <td>± ---</td> </tr> <tr> <td>2 PLACES</td> <td>± ---</td> <td>± ---</td> </tr> <tr> <td>1 PLACE</td> <td>± ---</td> <td>± ---</td> </tr> <tr> <td colspan="3">ANGULAR ± ---°</td> </tr> </table>		mm	INCH	4 PLACES	± ---	± ---	3 PLACES	± ---	± ---	2 PLACES	± ---	± ---	1 PLACE	± ---	± ---	ANGULAR ± ---°			DIMENSION STYLE IN/MM DRAWN BY DATE JFZHENG 2006/09/08 CHECKED BY DATE JFZHENG 2006/09/08 APPROVED BY DATE DQLUO 2006/09/08	SCALE --- DESIGN UNITS INCH THIRD ANGLE PROJECTION	TITLE HDMI(M) TO DVI(M) GOLD CABLE 28#AWG
		mm	INCH																				
	4 PLACES	± ---	± ---																				
	3 PLACES	± ---	± ---																				
2 PLACES	± ---	± ---																					
1 PLACE	± ---	± ---																					
ANGULAR ± ---°																							
DRAFT WHERE APPLICABLE MUST REMAIN WITHIN DIMENSIONS	MATERIAL NO. 6876728/29/30/31	DOCUMENT NO. SD-68767-028	SHEET NO. 1 OF 2	MOLEX INCORPORATED																			
SIZE A 4	THIS DRAWING CONTAINS INFORMATION THAT IS PROPRIETARY TO MOLEX INCORPORATED AND SHOULD NOT BE USED WITHOUT WRITTEN PERMISSION																						
REV 2	DESCRIPTION																						

6

5

4

3

2

1

NOTE:

1. OVERMOLD SPECIFICATION:

- 1.1 DVI BOOT MOLDED SNOW WHITE PVC RESIN 887800076,UL94V-0.
- 1.2 HDMI INNERMOLD WITH BK PVC 887800019.
HDMI OVERMOLD WITH PVC 887800150.
- 1.3 HDMI DUST COVER WITH PE 887800008.

2. MECHANICAL SPECIFICATION:

- 2.1 CABLE SHOULD STAND THE PULL FORCE 89-111N FOR 30 SECONDS WITH NO VISIBLE TERMINATION DAMAGE.
- 2.2 CABLE SHOULD PASS THE FLEX TEST IN 100 CYCLES AT EACH OF PLANES, PER EIA 364-41, CONDITION 1.

3. PRODUCT ELECTRICAL SPECIFICATION:

- 3.1 DIELECTRIC STRENGTH.
- 3.2 INSULATION RESISTANCE.
- 3.3 CONDUCTIVE RESISTANCE.
- 3.4 TMDS Signals Time Domain Impedence
- 3.5 TMDS Signals Time Domain Crosstalk:FEXT
- 3.6 TMDS Signals Skew
- 3.7 Attenuation

REFER TO ES-002 ELECTRICAL SPECIFICATION FOR DETAILS.

4. DVI CONNECTOR SPECIFICATION:

- 4.1 REFER TO PRODUCT SPEC. PS74320-001.
- 4.2 CONTACT PLATING: AU FLASH.

5. THIS PRODUCT MUST MEET ROHS COMPLIANCE.

SHIELD	SHIELD	OVERALL SHIELD	GROUND
PIN 19	PIN 16	WHITE	HOT PLUG DETECT
PIN 18	PIN 14	YELLOW	POWER +5V
PIN 17	PIN 15	ORANGE	GROUND(+5V&DDC)
PIN 16	PIN 7	RED	DDC DATA(SDA)
PIN 15	PIN 6	VIOLET	DDC CLOCK(SCL)
PIN 12	PIN 24	WHITE	TMDS CLOCK-
PIN 11	PIN 22	BRAID	TMDS CLOCK SHIELD
PIN 10	PIN 23	BROWN	TMDS CLOCK+
PIN 9	PIN 17	WHITE	TMDS DATA 0-
PIN 8	PIN 19	BRAID	TMDS DATA 0 SHIELD
PIN 7	PIN 18	BLUE	TMDS DATA 0+
PIN 6	PIN 9	WHITE	TMDS DATA 1-
PIN 5	PIN 11	BRAID	TMDS DATA 1 SHIELD
PIN 4	PIN 10	GREEN	TMDS DATA 1+
PIN 3	PIN 1	WHITE	TMDS DATA 2-
PIN 2	PIN 3	BRAID	TMDS DATA 2 SHIELD
PIN 1	PIN 2	RED	TMDS DATA 2+
HDMI	DVI-D	COLOR	CABLE FUNCTION

ITEM	DESCRIPTION	QTY.
H	HDMI SMALL METAL PLATE 47152-6009	1
G	HDMI METAL CAN GOLD PLATED 47152-4002	1
F	HDMI HOUSING ASSY' BLACK 47152-1000	1
E	DVI THUMB SCREW GOLD PLATED. 172000522	2
D	PCB 887899569/887899570	1
C	ONE BODY CAN 887899392	1
B	DVI_D SINGLE CHANNEL G/F CONNECTOR 172000443	1
A	DVI SINGLE LINK CABLE 8878008276	1

Released EC NO: DG2007-0029 DRWN: JFZHENG 2006/09/08 CHKD: JFZHENG 2006/09/08 APPR: DQ LUO 2006/09/11	DESCRIPTION QUALITY SYMBOLS ▽=0 ▽=0	GENERAL TOLERANCES (UNLESS SPECIFIED)		DIMENSION STYLE MM ONLY		SCALE ---	DESIGN UNITS METRIC	THIRD ANGLE PROJECTION		
		4 PLACES	±---	±---	DRAWN BY	DATE	TITLE			
		3 PLACES	±---	±---	JFZHENG	2006/09/08	HDMI(M) TO DVI(M) GOLD CABLE 28AWG			
2 PLACES	±---	±---	CHECKED BY	DATE	MOLEX INCORPORATED					
1 PLACE	±---	±---	JF ZHENG	2006/09/08						
ANGULAR ±---°			APPROVED BY	DATE	MATERIAL NO.	DOCUMENT NO.	SHEET NO.			
DRAFT WHERE APPLICABLE MUST REMAIN WITHIN DIMENSIONS			DQ LUO	2006/09/08	68767-00-28/29/30	SD-68767-029	2 OF 2			
SIZE		THIS DRAWING CONTAINS INFORMATION THAT IS PROPRIETARY TO MOLEX INCORPORATED AND SHOULD NOT BE USED WITHOUT WRITTEN PERMISSION								
A 4										