

# Series



S Series

100 Series

VP Series

MCS Series

MC Series

M Series

MOD Series

- Operating voltages up to 40 kVDC
- Operating current up to 30 Amps
- Advanced contact technology
- Silver plated and gold plated contacts available
- High performance insulation material

# General characteristics and technical data Series S

Housing	
Locking system	threaded coupling
Mounting type (panel mount connector)	round flange / 4-hole flange
Housing material	brass (CuZn)
Surface plating	nickel (Ni)
Protection class (mated connector)	IP50
Operating temperature	-30°C to +80°C

Contacts	
Termination method	solder / screw
Rated current	30 A
Max. operating current	40 A
Pulse current	3000 A
Contact resistance	300 $\mu\Omega$
Contact diameter	2.5 mm [.098"]
Max. wire size	AWG 14 / 2.5 mm <sup>2</sup>
Contact material	brass (CuZn)
Contact plating	silver (Ag) / gold (Au)
Insertion / Withdrawal force	5.5 N / 4.0 N
Mating cycles	100 k
Rated temperature	+120°C

Insulation inserts	
Number of contacts	1
Insulation material	PTFE or POM
Flammability class PTFE	UL94 V-0
Flammability class POM	UL94 HB
CTI value	600
Operating temperature PTFE	-50°C to +200°C
Operating temperature POM	-30°C to +120°C
Insulating material group PTFE / POM	I (DIN IEC 60664)

## Suitable cable dimensions

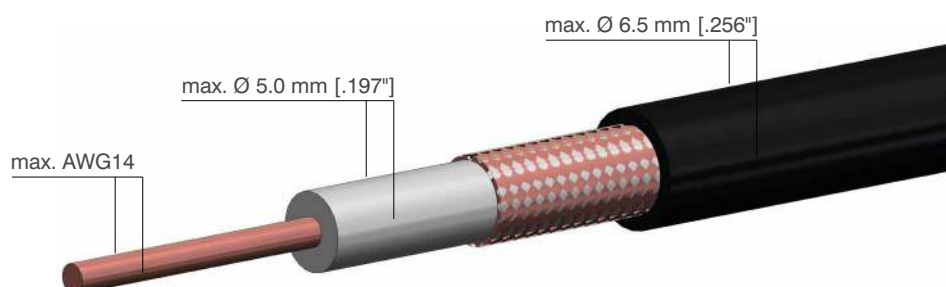

Electrical values	
Operating voltage (DC)	30 kV
Test voltage (DC)	45 kV
Rated current	30 A
Maximum operating current	40 A
Pulse current	3000 A
Characteristics	
Insulation material	PTFE
Mounting type receptacle	4-hole flange
Contact plating	silver (Ag) or gold (Au)

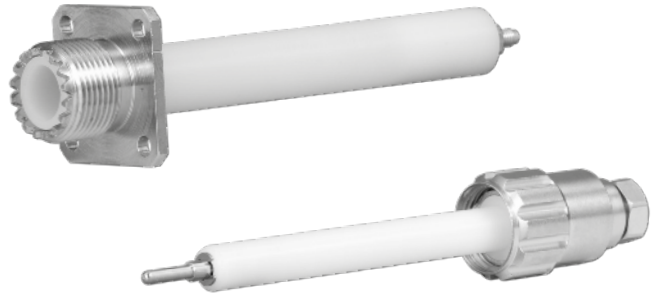

HB30 receptacle, panel mount      HS30 plug, cable mount

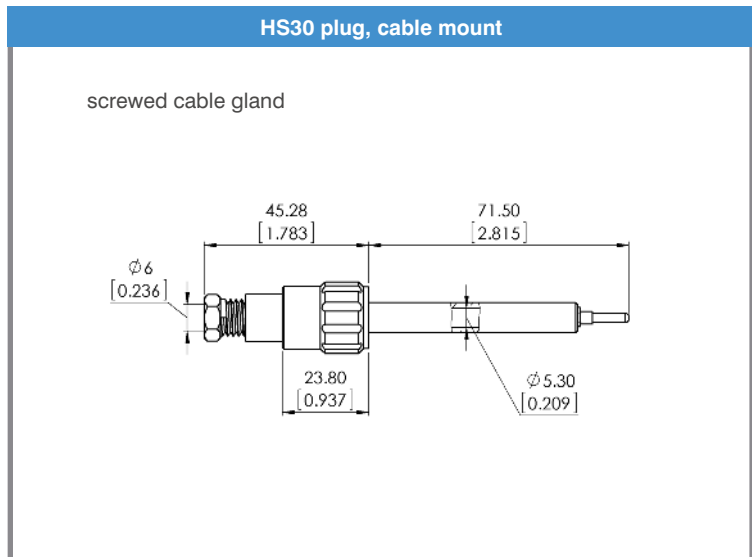
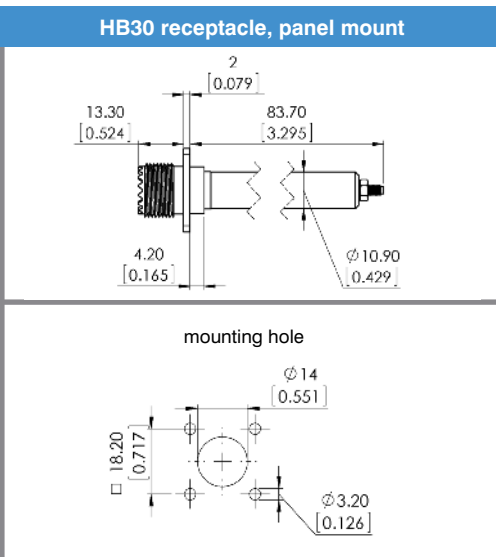

drawing - dimensions in mm [inch]

Part No.	Description	Plug, cable mount	Receptacle, panel mount	Contact silver plated	Contact gold plated
7331050	HS30 PTFE	•		•	
<b>7331051</b>	<b>HB30 PTFE</b>		•	•	
7331150	HS30/Au PTFE	•			•
7331151	HB30/Au PTFE		•		•

**Suitable HV cable, shielded**

Part No.	Operating Voltage	Wire size	Outer diameter	Min. bend radius	Temperature range
3330007	30 kVDC	AWG22 (0.35 mm <sup>2</sup> )	5.40 mm [.213"]	54 mm [2.126"]	-25 °C / +90 °C

➔ For more information please see page 26

# Assembly instructions HS (plug, cable mount)

1.



Part as supplied

2.



**Parts included**

Screw joint (1), screw (2), washer (3), clamping rubber (4), outer cone (5), basic part (6), snap ring (7), male contact (8).

3.



**Remove male contact**

Loose snap ring (7) and take out male contact (8).

4.

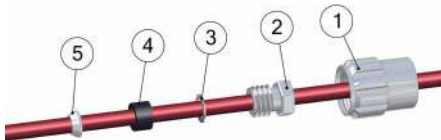

Place screw joint (1), screw (2), washer (3), clamping rubber (4), outer cone (5) on cable

⚠ Respect correct order of parts (see picture)

5.



Remove cable jacket

Type	L1 mm [inch]
HS 10/11	31 [1.220"]
HS 20/21	56 [2.205"]
HS 30/31	69 [2.717"]
HS 40	104 [4.094"]

⚠ Do not damage metal shield. Do not damage dielectric insulation. Respect correct order of parts (see picture)

6.



Fold back shield braid over jacket

7.

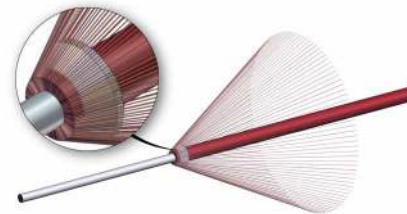

**Prepare shield braid for cutting**

Completely widen braid. Push outer cone (5) completely under shield braid.

8.



**Cut overlapping shield**

⚠ Carefully remove shield parts. Loose shield parts can cause electrical break down.

9.



Remove dielectric insulation (L2 = 5mm [.197"])

10.



**Solder contact (8) on conductor**

⚠ Tin-solder must not remain on contact surface

**11.**



Completely insert cable in basic part (6)

**12.**



Completely slide clamping rubber (4) and washer (3) into basic part (6). Close housing with screw (2) (tightening torque = 3 Nm)

**13.**



Fix male contact (8) with snap ring (7)

**14.**



Put screw joint (1) on basic part (6)

**15.**



Assembly finished



**Note – important!**

1. Please carefully read assembly instructions before cable assembly.
2. Cable assembly must only be done by trained and qualified personnel.

# Assembly instructions GB (plug, cable mount)

1.



Part as supplied

5.



Solder contact (8) on conductor

⚠ Tin-solder must not remain on contact surface

2.

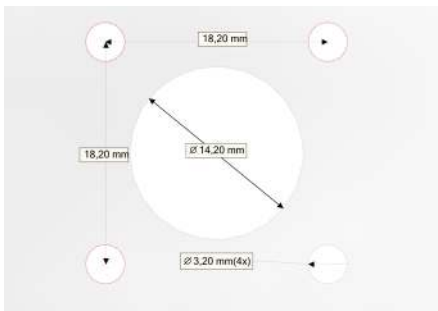

Panel cut out

6.



💡 It is recommended to protect solder point with a shrinking tube (shrinking tube not included).

3.



⚠ For shielded cables: Fold back shield and make sure shield is insulated from solder point (conductor to contact - see step 5.)

4.



Remove dielectric insulation



## Note – important!

1. Please carefully read assembly instructions before cable assembly.
2. Cable assembly must only be done by trained and qualified personnel.