

# 74LVC8T245; 74LVCH8T245

8-bit dual supply translating transceiver; 3-state

Rev. 5 — 29 April 2021

Product data sheet

## 1. General description

The 74LVC8T245; 74LVCH8T245 are 8-bit dual supply translating transceivers with 3-state outputs that enable bidirectional level translation. They feature two data input-output ports (pins An and Bn), a direction control input (DIR), an output enable input ( $\overline{OE}$ ) and dual supply pins ( $V_{CC(A)}$  and  $V_{CC(B)}$ ). Both  $V_{CC(A)}$  and  $V_{CC(B)}$  can be supplied at any voltage between 1.2 V and 5.5 V making the device suitable for translating between any of the low voltage nodes (1.2 V, 1.5 V, 1.8 V, 2.5 V, 3.3 V and 5.0 V). Pins An,  $\overline{OE}$  and DIR are referenced to  $V_{CC(A)}$  and pins Bn are referenced to  $V_{CC(B)}$ . A HIGH on DIR allows transmission from An to Bn and a LOW on DIR allows transmission from Bn to An. The output enable input ( $\overline{OE}$ ) can be used to disable the outputs so the buses are effectively isolated.

The devices are fully specified for partial power-down applications using  $I_{OFF}$ . The  $I_{OFF}$  circuitry disables the output, preventing any damaging backflow current through the device when it is powered down. In suspend mode when either  $V_{CC(A)}$  or  $V_{CC(B)}$  are at GND level, both A port and B port are in the high-impedance OFF-state.

Active bus hold circuitry in the 74LVCH8T245 holds unused or floating data inputs at a valid logic level.

## 2. Features and benefits

- Wide supply voltage range:
  - $V_{CC(A)}$ : 1.2 V to 5.5 V
  - $V_{CC(B)}$ : 1.2 V to 5.5 V
- High noise immunity
- Complies with JEDEC standards:
  - JESD8-7 (1.2 V to 1.95 V)
  - JESD8-5 (1.8 V to 2.7 V)
  - JESD8C (2.7 V to 3.6 V)
  - JESD36 (4.5 V to 5.5 V)
- ESD protection:
  - HBM JESD22-A114F Class 3A exceeds 4000 V
  - MM JESD22-A115-B exceeds 200 V
  - CDM JESD22-C101E exceeds 1000 V
- Maximum data rates:
  - 420 Mbps (3.3 V to 5.0 V translation)
  - 210 Mbps (translate to 3.3 V)
  - 140 Mbps (translate to 2.5 V)
  - 75 Mbps (translate to 1.8 V)
  - 60 Mbps (translate to 1.5 V)
- Suspend mode
- Latch-up performance exceeds 100 mA per JESD 78B Class II
- $\pm 24$  mA output drive ( $V_{CC} = 3.0$  V)
- Inputs accept voltages up to 5.5 V
- Low power consumption: 30  $\mu$ A maximum  $I_{CC}$
- $I_{OFF}$  circuitry provides partial Power-down mode operation
- Specified from -40 °C to +85 °C and -40 °C to +125 °C

### 3. Ordering information

Table 1. Ordering information

| Type number   | Package           |          |   |           |
|---------------|-------------------|----------|---|-----------|
|               | Temperature range | Name     | Description   | Version   |
| 74LVC8T245PW  | -40 °C to +125 °C | TSSOP24  | plastic thin shrink small outline package; 24 leads; body width 4.4 mm  | SOT355-1  |
| 74LVCH8T245PW |                   |          |   |           |
| 74LVC8T245BQ  | -40 °C to +125 °C | DHVQFN24 | plastic dual in-line compatible thermal enhanced very thin quad flat package; no leads; 24 terminals; body 3.5 × 5.5 × 0.85 mm                              | SOT815-1  |
| 74LVCH8T245BQ |                   |          |   |           |
| 74LVC8T245BZ  | -40 °C to +125 °C | DHXQFN24 | plastic, leadless dual in-line compatible thermal enhanced extreme thin quad flat package; no leads; 24 terminals; 0.4 mm pitch; body 2 mm × 4 mm × 0.48 mm | SOT8024-1 |

### 4. Functional diagram

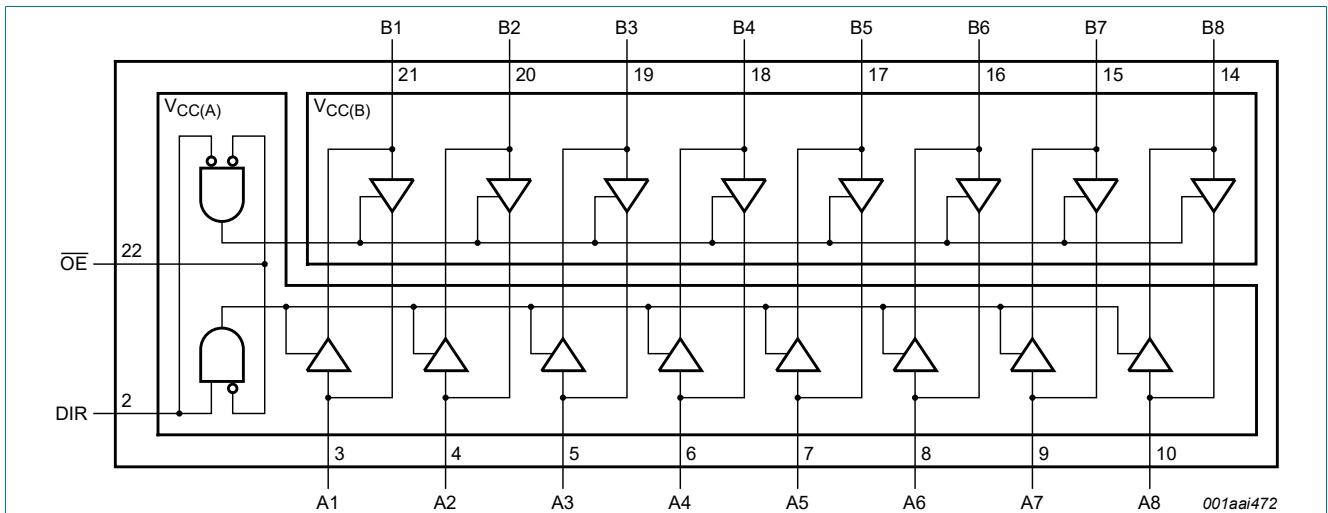

Fig. 1. Logic symbol

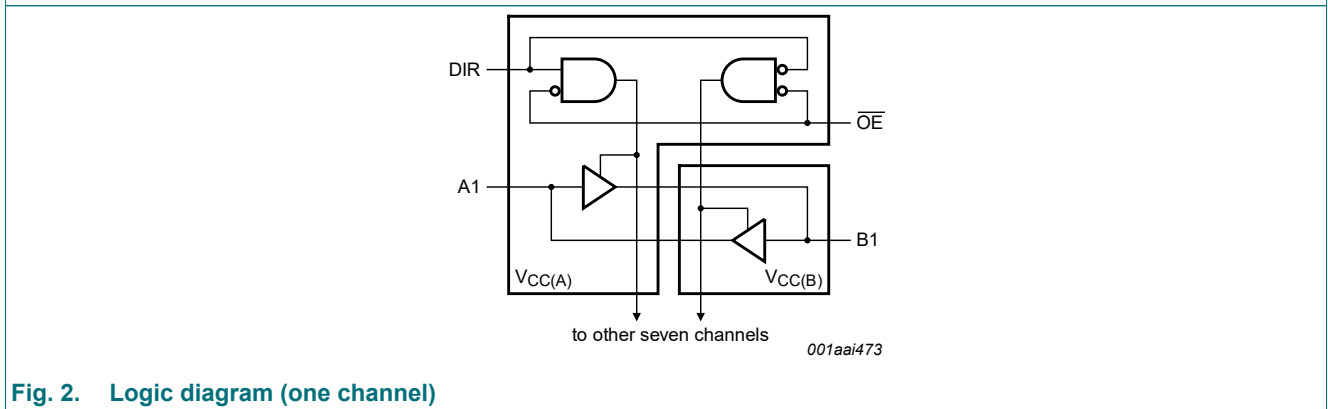
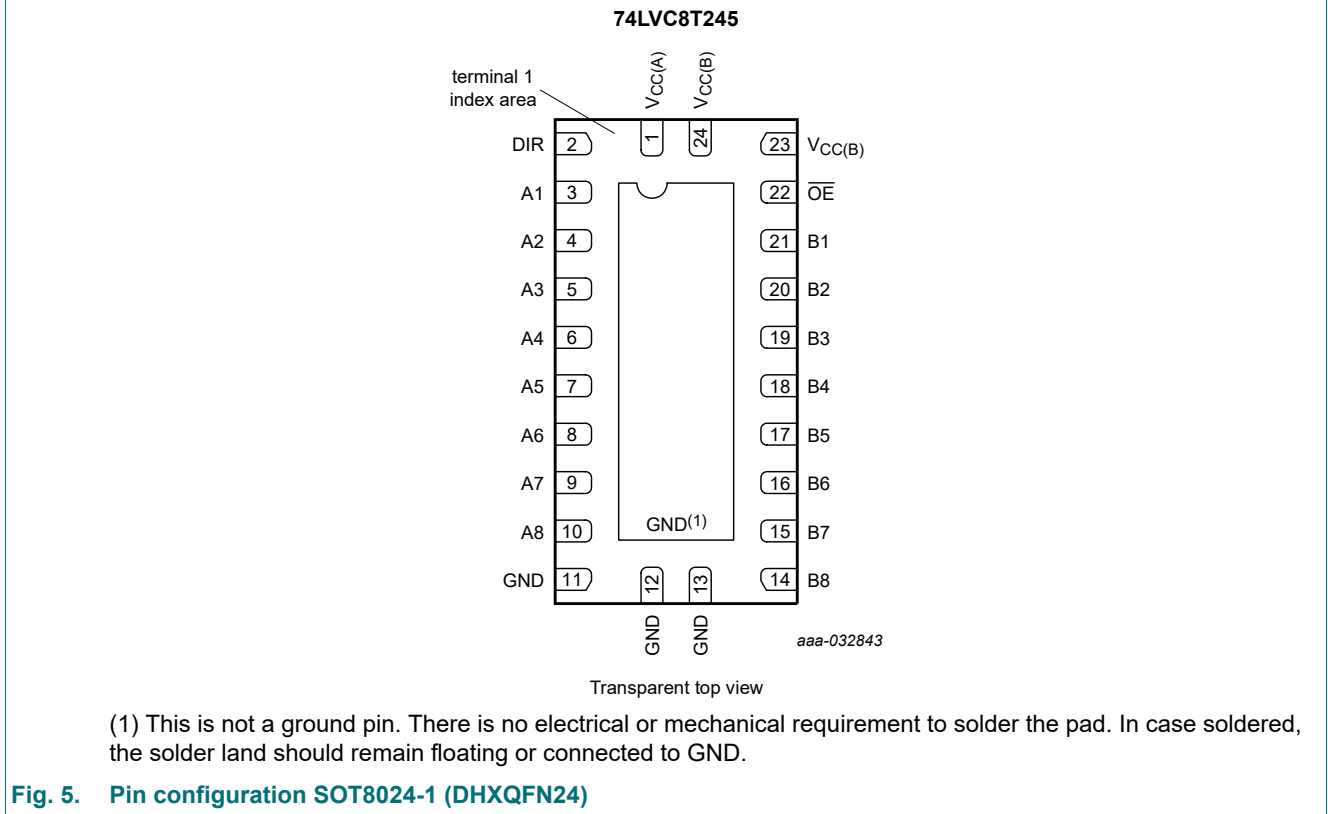
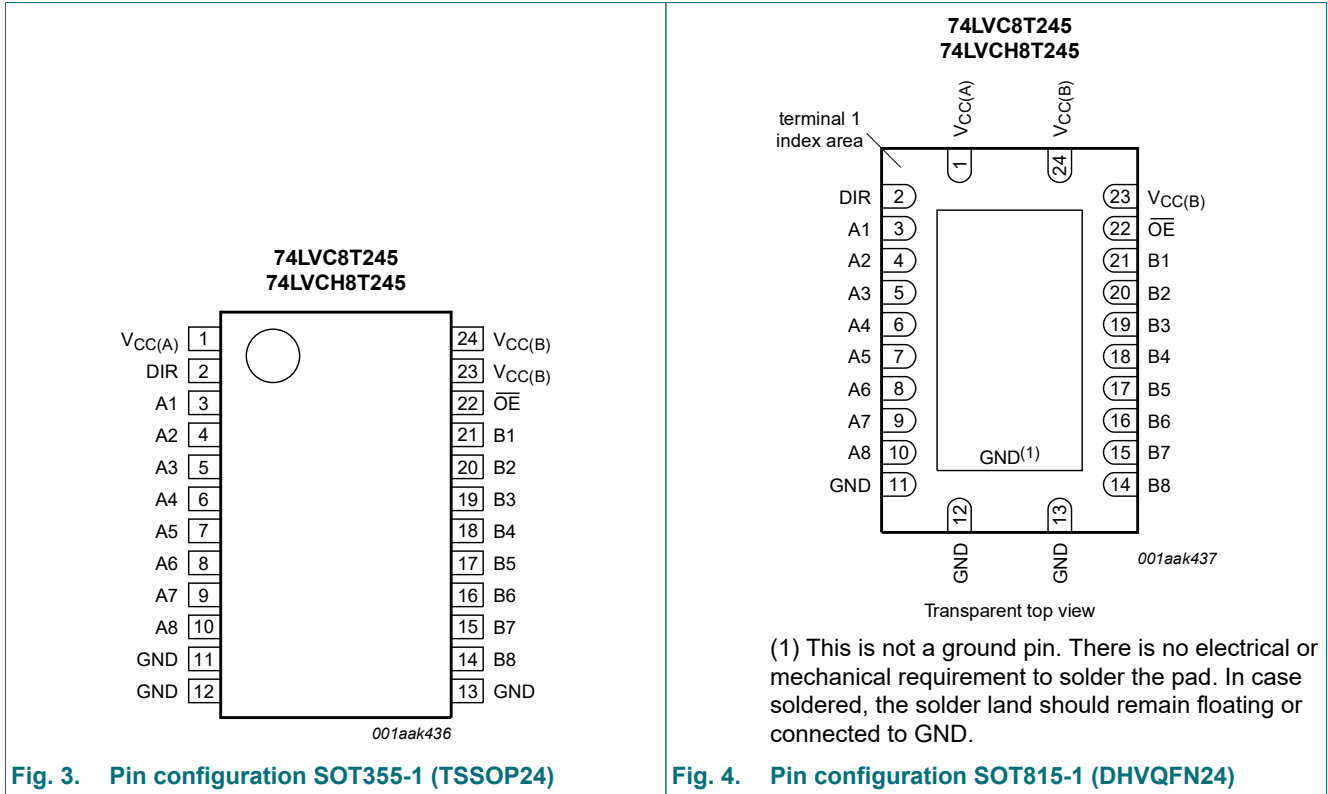

Fig. 2. Logic diagram (one channel)

5. Pinning information

5.1. Pinning



## 5.2. Pin description

Table 2. Pin description

| Symbol                            | Pin                               | Description  |
|-----------------------------------|-----------------------------------|--|
| $V_{CC(A)}$                       | 1                                 | supply voltage A<br>(An inputs/outputs, $\overline{OE}$ and DIR inputs are referenced to $V_{CC(A)}$ ) |
| DIR                               | 2                                 | direction control  |
| A1, A2, A3, A4,<br>A5, A6, A7, A8 | 3, 4, 5, 6,<br>7, 8, 9, 10        | data input or output   |
| GND [1]                           | 11, 12, 13                        | ground (0 V)   |
| B1, B2, B3, B4,<br>B5, B6, B7, B8 | 21, 20, 19, 18,<br>17, 16, 15, 14 | data input or output   |
| $\overline{OE}$                   | 22                                | output enable input (active LOW)   |
| $V_{CC(B)}$                       | 23, 24                            | supply voltage B (Bn inputs/outputs are referenced to $V_{CC(B)}$ )                                    |

[1] All GND pins must be connected to ground (0 V).

## 6. Functional description

Table 3. Function table

H = HIGH voltage level; L = LOW voltage level; X = don't care; Z = high-impedance OFF-state.

| Supply voltage | Input               |         | Input/output [1] |         |
|----------------|---------------------|---------|------------------|---------|
|                | $\overline{OE}$ [2] | DIR [2] | An [2]           | Bn [2]  |
| 1.2 V to 5.5 V | L                   | L       | An = Bn          | input   |
| 1.2 V to 5.5 V | L                   | H       | input            | Bn = An |
| 1.2 V to 5.5 V | H                   | X       | Z                | Z       |
| GND [1]        | X                   | X       | Z                | Z       |

[1] If at least one of  $V_{CC(A)}$  or  $V_{CC(B)}$  is at GND level, the device goes into suspend mode.

[2] The An inputs/outputs, DIR and  $\overline{OE}$  input circuit is referenced to  $V_{CC(A)}$ ; The Bn inputs/outputs circuit is referenced to  $V_{CC(B)}$ .

## 7. Limiting values

**Table 4. Limiting values**

In accordance with the Absolute Maximum Rating System (IEC 60134). Voltages are referenced to GND (ground = 0 V).

| Symbol      | Parameter               | Conditions                                    | Min  | Max             | Unit |
|-------------|-------------------------|---|------|-----------------|------|
| $V_{CC(A)}$ | supply voltage A        |   | -0.5 | +6.5            | V    |
| $V_{CC(B)}$ | supply voltage B        |   | -0.5 | +6.5            | V    |
| $I_{IK}$    | input clamping current  | $V_I < 0$ V                                   | -50  | -               | mA   |
| $V_I$       | input voltage           | [1]   | -0.5 | +6.5            | V    |
| $I_{OK}$    | output clamping current | $V_O < 0$ V                                   | -50  | -               | mA   |
| $V_O$       | output voltage          | Active mode [1] [2] [3]                       | -0.5 | $V_{CCO} + 0.5$ | V    |
|             |                         | Suspend or 3-state mode [1]                   | -0.5 | +6.5            | V    |
| $I_O$       | output current          | $V_O = 0$ V to $V_{CCO}$ [2]                  | -    | $\pm 50$        | mA   |
| $I_{CC}$    | supply current          | $I_{CC(A)}$ or $I_{CC(B)}$ ; per $V_{CC}$ pin | -    | 100             | mA   |
| $I_{GND}$   | ground current          | per GND pin                                   | -100 | -               | mA   |
| $T_{stg}$   | storage temperature     |   | -65  | +150            | °C   |
| $P_{tot}$   | total power dissipation | $T_{amb} = -40$ °C to $+125$ °C               |      |                 |      |
|             |                         | SOT355-1; SOT815-1 [4]                        | -    | 500             | mW   |
|             |                         | SOT8024-1                                     | -    | 250             | mW   |

[1] The minimum input voltage ratings and output voltage ratings may be exceeded if the input and output current ratings are observed.

[2]  $V_{CCO}$  is the supply voltage associated with the output port.

[3]  $V_{CCO} + 0.5$  V should not exceed 6.5 V.

[4] For SOT355-1 (TSSOP24) package:  $P_{tot}$  derates linearly with 12.4 mW/K above 110 °C.  
For SOT815-1 (DHVQFN24) package:  $P_{tot}$  derates linearly with 15.0 mW/K above 117 °C.

## 8. Recommended operating conditions

**Table 5. Recommended operating conditions**

| Symbol              | Parameter                           | Conditions                  | Min | Max       | Unit |
|---------------------|-------------------------------------|-----------------------------|-----|-----------|------|
| $V_{CC(A)}$         | supply voltage A                    |                             | 1.2 | 5.5       | V    |
| $V_{CC(B)}$         | supply voltage B                    |                             | 1.2 | 5.5       | V    |
| $V_I$               | input voltage                       |                             | 0   | 5.5       | V    |
| $V_O$               | output voltage                      | Active mode [1]             | 0   | $V_{CCO}$ | V    |
|                     |                                     | Suspend or 3-state mode     | 0   | 5.5       | V    |
| $T_{amb}$           | ambient temperature                 |                             | -40 | +125      | °C   |
| $\Delta t/\Delta V$ | input transition rise and fall rate | $V_{CCI} = 1.2$ V [2]       | -   | 20        | ns/V |
|                     |                                     | $V_{CCI} = 1.4$ V to 1.95 V | -   | 20        | ns/V |
|                     |                                     | $V_{CCI} = 2.3$ V to 2.7 V  | -   | 20        | ns/V |
|                     |                                     | $V_{CCI} = 3$ V to 3.6 V    | -   | 10        | ns/V |
|                     |                                     | $V_{CCI} = 4.5$ V to 5.5 V  | -   | 5         | ns/V |

[1]  $V_{CCO}$  is the supply voltage associated with the output port.

[2]  $V_{CCI}$  is the supply voltage associated with the input port.

## 9. Static characteristics

**Table 6. Typical static characteristics at  $T_{amb} = 25\text{ °C}$**

At recommended operating conditions; voltages are referenced to GND (ground = 0 V).

| Symbol     | Parameter                       | Conditions  | Min | Typ  | Max     | Unit          |
|------------|---------------------------------|---|-----|------|---------|---------------|
| $V_{OH}$   | HIGH-level output voltage       | $V_I = V_{IH}$ or $V_{IL}$ [1]  |     |      |         |               |
|            |                                 | $I_O = -3\text{ mA}$ ; $V_{CCO} = 1.2\text{ V}$   | -   | 1.09 | -       | V             |
| $V_{OL}$   | LOW-level output voltage        | $V_I = V_{IH}$ or $V_{IL}$  |     |      |         |               |
|            |                                 | $I_O = 3\text{ mA}$ ; $V_{CCO} = 1.2\text{ V}$ [1]  | -   | 0.07 | -       | V             |
| $I_I$      | input leakage current           | DIR, $\overline{OE}$ input; $V_I = 0\text{ V}$ to $5.5\text{ V}$ ; $V_{CCI} = 1.2\text{ V}$ to $5.5\text{ V}$ [2]               | -   | -    | $\pm 1$ | $\mu\text{A}$ |
| $I_{BHL}$  | bus hold LOW current            | A or B port; $V_I = 0.42\text{ V}$ ; $V_{CCI} = 1.2\text{ V}$ [2]   | -   | 19   | -       | $\mu\text{A}$ |
| $I_{BHH}$  | bus hold HIGH current           | A or B port; $V_I = 0.78\text{ V}$ ; $V_{CCI} = 1.2\text{ V}$ [2]   | -   | -19  | -       | $\mu\text{A}$ |
| $I_{BHLO}$ | bus hold LOW overdrive current  | A or B port; $V_{CCI} = 1.2\text{ V}$ [2] [3]   | -   | 19   | -       | $\mu\text{A}$ |
| $I_{BHHO}$ | bus hold HIGH overdrive current | A or B port; $V_{CCI} = 1.2\text{ V}$ [2] [3]   | -   | -19  | -       | $\mu\text{A}$ |
| $I_{OZ}$   | OFF-state output current        | A or B port; $V_O = 0\text{ V}$ or $V_{CCO}$ ; $V_{CCO} = 1.2\text{ V}$ to $5.5\text{ V}$ [1]                                   | -   | -    | $\pm 1$ | $\mu\text{A}$ |
|            |                                 | suspend mode A port; $V_O = 0\text{ V}$ or $V_{CCO}$ ; $V_{CC(A)} = 5.5\text{ V}$ ; $V_{CC(B)} = 0\text{ V}$ [1]                | -   | -    | $\pm 1$ | $\mu\text{A}$ |
|            |                                 | suspend mode B port; $V_O = 0\text{ V}$ or $V_{CCO}$ ; $V_{CC(A)} = 0\text{ V}$ ; $V_{CC(B)} = 5.5\text{ V}$ [1]                | -   | -    | $\pm 1$ | $\mu\text{A}$ |
| $I_{OFF}$  | power-off leakage current       | A port; $V_I$ or $V_O = 0\text{ V}$ to $5.5\text{ V}$ ; $V_{CC(A)} = 0\text{ V}$ ; $V_{CC(B)} = 1.2\text{ V}$ to $5.5\text{ V}$ | -   | -    | $\pm 1$ | $\mu\text{A}$ |
|            |                                 | B port; $V_I$ or $V_O = 0\text{ V}$ to $5.5\text{ V}$ ; $V_{CC(B)} = 0\text{ V}$ ; $V_{CC(A)} = 1.2\text{ V}$ to $5.5\text{ V}$ | -   | -    | $\pm 1$ | $\mu\text{A}$ |
| $C_I$      | input capacitance               | DIR, $\overline{OE}$ input; $V_I = 0\text{ V}$ or $3.3\text{ V}$ ; $V_{CC(A)} = 3.3\text{ V}$                                   | -   | 3    | -       | pF            |
| $C_{I/O}$  | input/output capacitance        | A and B port; $V_O = 3.3\text{ V}$ or $0\text{ V}$ ; $V_{CC(A)} = V_{CC(B)} = 3.3\text{ V}$                                     | -   | 6.5  | -       | pF            |

[1]  $V_{CCO}$  is the supply voltage associated with the output port.

[2]  $V_{CCI}$  is the supply voltage associated with the data input port.

[3] To guarantee the node switches, an external driver must source/sink at least  $I_{BHLO} / I_{BHHO}$  when the input is in the range  $V_{IL}$  to  $V_{IH}$ .

Table 7. Static characteristics

At recommended operating conditions; voltages are referenced to GND (ground = 0 V).

| Symbol          | Parameter                 | Conditions  | -40 °C to +85 °C       |                        | -40 °C to +125 °C      |                        | Unit |
|-----------------|---------------------------|---|------------------------|------------------------|------------------------|------------------------|------|
|                 |                           |   | Min                    | Max                    | Min                    | Max                    |      |
| V <sub>IH</sub> | HIGH-level input voltage  | data input [1]  |                        |                        |                        |                        |      |
|                 |                           | V <sub>CCI</sub> = 1.2 V  | 0.8V <sub>CCI</sub>    | -                      | 0.8V <sub>CCI</sub>    | -                      | V    |
|                 |                           | V <sub>CCI</sub> = 1.4 V to 1.95 V  | 0.65V <sub>CCI</sub>   | -                      | 0.65V <sub>CCI</sub>   | -                      | V    |
|                 |                           | V <sub>CCI</sub> = 2.3 V to 2.7 V   | 1.7                    | -                      | 1.7                    | -                      | V    |
|                 |                           | V <sub>CCI</sub> = 3.0 V to 3.6 V   | 2.0                    | -                      | 2.0                    | -                      | V    |
|                 |                           | V <sub>CCI</sub> = 4.5 V to 5.5 V   | 0.7V <sub>CCI</sub>    | -                      | 0.7V <sub>CCI</sub>    | -                      | V    |
|                 |                           | DIR, $\overline{\text{OE}}$ input   |                        |                        |                        |                        |      |
|                 |                           | V <sub>CCI</sub> = 1.2 V  | 0.8V <sub>CC(A)</sub>  | -                      | 0.8V <sub>CC(A)</sub>  | -                      | V    |
|                 |                           | V <sub>CCI</sub> = 1.4 V to 1.95 V  | 0.65V <sub>CC(A)</sub> | -                      | 0.65V <sub>CC(A)</sub> | -                      | V    |
|                 |                           | V <sub>CCI</sub> = 2.3 V to 2.7 V   | 1.7                    | -                      | 1.7                    | -                      | V    |
|                 |                           | V <sub>CCI</sub> = 3.0 V to 3.6 V   | 2.0                    | -                      | 2.0                    | -                      | V    |
|                 |                           | V <sub>CCI</sub> = 4.5 V to 5.5 V   | 0.7V <sub>CC(A)</sub>  | -                      | 0.7V <sub>CC(A)</sub>  | -                      | V    |
| V <sub>IL</sub> | LOW-level input voltage   | data input [1]  |                        |                        |                        |                        |      |
|                 |                           | V <sub>CCI</sub> = 1.2 V  | -                      | 0.2V <sub>CCI</sub>    | -                      | 0.2V <sub>CCI</sub>    | V    |
|                 |                           | V <sub>CCI</sub> = 1.4 V to 1.95 V  | -                      | 0.35V <sub>CCI</sub>   | -                      | 0.35V <sub>CCI</sub>   | V    |
|                 |                           | V <sub>CCI</sub> = 2.3 V to 2.7 V   | -                      | 0.7                    | -                      | 0.7                    | V    |
|                 |                           | V <sub>CCI</sub> = 3.0 V to 3.6 V   | -                      | 0.8                    | -                      | 0.8                    | V    |
|                 |                           | V <sub>CCI</sub> = 4.5 V to 5.5 V   | -                      | 0.3V <sub>CCI</sub>    | -                      | 0.3V <sub>CCI</sub>    | V    |
|                 |                           | DIR, $\overline{\text{OE}}$ input   |                        |                        |                        |                        |      |
|                 |                           | V <sub>CCI</sub> = 1.2 V  | -                      | 0.2V <sub>CC(A)</sub>  | -                      | 0.2V <sub>CC(A)</sub>  | V    |
|                 |                           | V <sub>CCI</sub> = 1.4 V to 1.95 V  | -                      | 0.35V <sub>CC(A)</sub> | -                      | 0.35V <sub>CC(A)</sub> | V    |
|                 |                           | V <sub>CCI</sub> = 2.3 V to 2.7 V   | -                      | 0.7                    | -                      | 0.7                    | V    |
|                 |                           | V <sub>CCI</sub> = 3.0 V to 3.6 V   | -                      | 0.8                    | -                      | 0.8                    | V    |
|                 |                           | V <sub>CCI</sub> = 4.5 V to 5.5 V   | -                      | 0.3V <sub>CC(A)</sub>  | -                      | 0.3V <sub>CC(A)</sub>  | V    |
| V <sub>OH</sub> | HIGH-level output voltage | V <sub>I</sub> = V <sub>IH</sub>  |                        |                        |                        |                        |      |
|                 |                           | I <sub>O</sub> = -100 μA; V <sub>CCO</sub> = 1.2 V to 4.5 V [2]                                     | V <sub>CCO</sub> - 0.1 | -                      | V <sub>CCO</sub> - 0.1 | -                      | V    |
|                 |                           | I <sub>O</sub> = -6 mA; V <sub>CCO</sub> = 1.4 V  | 1.0                    | -                      | 1.0                    | -                      | V    |
|                 |                           | I <sub>O</sub> = -8 mA; V <sub>CCO</sub> = 1.65 V   | 1.2                    | -                      | 1.2                    | -                      | V    |
|                 |                           | I <sub>O</sub> = -12 mA; V <sub>CCO</sub> = 2.3 V   | 1.9                    | -                      | 1.9                    | -                      | V    |
|                 |                           | I <sub>O</sub> = -24 mA; V <sub>CCO</sub> = 3.0 V   | 2.4                    | -                      | 2.4                    | -                      | V    |
| V <sub>OL</sub> | LOW-level output voltage  | V <sub>I</sub> = V <sub>IL</sub> [2]  |                        |                        |                        |                        |      |
|                 |                           | I <sub>O</sub> = 100 μA; V <sub>CCO</sub> = 1.2 V to 4.5 V  | -                      | 0.1                    | -                      | 0.1                    | V    |
|                 |                           | I <sub>O</sub> = 6 mA; V <sub>CCO</sub> = 1.4 V   | -                      | 0.3                    | -                      | 0.3                    | V    |
|                 |                           | I <sub>O</sub> = 8 mA; V <sub>CCO</sub> = 1.65 V  | -                      | 0.45                   | -                      | 0.45                   | V    |
|                 |                           | I <sub>O</sub> = 12 mA; V <sub>CCO</sub> = 2.3 V  | -                      | 0.3                    | -                      | 0.3                    | V    |
|                 |                           | I <sub>O</sub> = 24 mA; V <sub>CCO</sub> = 3.0 V  | -                      | 0.55                   | -                      | 0.55                   | V    |
| I <sub>I</sub>  | input leakage current     | DIR, $\overline{\text{OE}}$ input; V <sub>I</sub> = 0 V to 5.5 V; V <sub>CCI</sub> = 1.2 V to 5.5 V | -                      | ±2                     | -                      | ±10                    | μA   |

| Symbol            | Parameter   | Conditions   | -40 °C to +85 °C |      | -40 °C to +125 °C |     | Unit |
|-------------------|---|--|------------------|------|-------------------|-----|------|
|                   |   |  | Min              | Max  | Min               | Max |      |
| I <sub>BHL</sub>  | bus hold LOW current                              | A or B port [1]  |                  |      |                   |     |      |
|                   |   | V <sub>I</sub> = 0.49 V; V <sub>CCI</sub> = 1.4 V  | 15               | -    | 10                | -   | μA   |
|                   |   | V <sub>I</sub> = 0.58 V; V <sub>CCI</sub> = 1.65 V   | 25               | -    | 20                | -   | μA   |
|                   |   | V <sub>I</sub> = 0.70 V; V <sub>CCI</sub> = 2.3 V  | 45               | -    | 45                | -   | μA   |
|                   |   | V <sub>I</sub> = 0.80 V; V <sub>CCI</sub> = 3.0 V  | 100              | -    | 80                | -   | μA   |
|                   | V <sub>I</sub> = 1.35 V; V <sub>CCI</sub> = 4.5 V | 100  | -                | 100  | -                 | μA  |      |
| I <sub>BHH</sub>  | bus hold HIGH current                             | A or B port [1]  |                  |      |                   |     |      |
|                   |   | V <sub>I</sub> = 0.91 V; V <sub>CCI</sub> = 1.4 V  | -15              | -    | -10               | -   | μA   |
|                   |   | V <sub>I</sub> = 1.07 V; V <sub>CCI</sub> = 1.65 V   | -25              | -    | -20               | -   | μA   |
|                   |   | V <sub>I</sub> = 1.70 V; V <sub>CCI</sub> = 2.3 V  | -45              | -    | -45               | -   | μA   |
|                   |   | V <sub>I</sub> = 2.00 V; V <sub>CCI</sub> = 3.0 V  | -100             | -    | -80               | -   | μA   |
|                   | V <sub>I</sub> = 3.15 V; V <sub>CCI</sub> = 4.5 V | -100   | -                | -100 | -                 | μA  |      |
| I <sub>BHLO</sub> | bus hold LOW overdrive current                    | A or B port [1] [3]  |                  |      |                   |     |      |
|                   |   | V <sub>CCI</sub> = 1.6 V   | 125              | -    | 125               | -   | μA   |
|                   |   | V <sub>CCI</sub> = 1.95 V  | 200              | -    | 200               | -   | μA   |
|                   |   | V <sub>CCI</sub> = 2.7 V   | 300              | -    | 300               | -   | μA   |
|                   |   | V <sub>CCI</sub> = 3.6 V   | 500              | -    | 500               | -   | μA   |
|                   | V <sub>CCI</sub> = 5.5 V                          | 900  | -                | 900  | -                 | μA  |      |
| I <sub>BHHO</sub> | bus hold HIGH overdrive current                   | A or B port [1] [3]  |                  |      |                   |     |      |
|                   |   | V <sub>CCI</sub> = 1.6 V   | -125             | -    | -125              | -   | μA   |
|                   |   | V <sub>CCI</sub> = 1.95 V  | -200             | -    | -200              | -   | μA   |
|                   |   | V <sub>CCI</sub> = 2.7 V   | -300             | -    | -300              | -   | μA   |
|                   |   | V <sub>CCI</sub> = 3.6 V   | -500             | -    | -500              | -   | μA   |
|                   | V <sub>CCI</sub> = 5.5 V                          | -900   | -                | -900 | -                 | μA  |      |
| I <sub>OZ</sub>   | OFF-state output current                          | A or B port; V <sub>O</sub> = 0 V or V <sub>CCO</sub> ; V <sub>CCO</sub> = 1.2 V to 5.5 V [2]                            | -                | ±2   | -                 | ±10 | μA   |
|                   |   | suspend mode A port; V <sub>O</sub> = 0 V or V <sub>CCO</sub> ; V <sub>CC(A)</sub> = 5.5 V; V <sub>CC(B)</sub> = 0 V [2] | -                | ±2   | -                 | ±10 | μA   |
|                   |   | suspend mode B port; V <sub>O</sub> = 0 V or V <sub>CCO</sub> ; V <sub>CC(A)</sub> = 0 V; V <sub>CC(B)</sub> = 5.5 V [2] | -                | ±2   | -                 | ±10 | μA   |
| I <sub>OFF</sub>  | power-off leakage current                         | A port; V <sub>I</sub> or V <sub>O</sub> = 0 V to 5.5 V; V <sub>CC(A)</sub> = 0 V; V <sub>CC(B)</sub> = 1.2 V to 5.5 V   | -                | ±2   | -                 | ±10 | μA   |
|                   |   | B port; V <sub>I</sub> or V <sub>O</sub> = 0 V to 5.5 V; V <sub>CC(B)</sub> = 0 V; V <sub>CC(A)</sub> = 1.2 V to 5.5 V   | -                | ±2   | -                 | ±10 | μA   |



| Symbol           | Parameter   | Conditions   | -40 °C to +85 °C |     | -40 °C to +125 °C |     | Unit |
|------------------|---|--|------------------|-----|-------------------|-----|------|
|                  |   |  | Min              | Max | Min               | Max |      |
| I <sub>CC</sub>  | supply current  | A port; V <sub>I</sub> = 0 V or V <sub>CCI</sub> ; I <sub>O</sub> = 0 A [1]  |                  |     |                   |     |      |
|                  |   | V <sub>CC(A)</sub> , V <sub>CC(B)</sub> = 1.2 V to 5.5 V   | -                | 15  | -                 | 20  | μA   |
|                  |   | V <sub>CC(A)</sub> = 5.5 V; V <sub>CC(B)</sub> = 0 V   | -                | 15  | -                 | 20  | μA   |
|                  |   | V <sub>CC(A)</sub> = 0 V; V <sub>CC(B)</sub> = 5.5 V   | -2               | -   | -4                | -   | μA   |
|                  |   | B port; V <sub>I</sub> = 0 V or V <sub>CCI</sub> ; I <sub>O</sub> = 0 A  |                  |     |                   |     |      |
|                  |   | V <sub>CC(A)</sub> , V <sub>CC(B)</sub> = 1.2 V to 5.5 V   | -                | 15  | -                 | 20  | μA   |
|                  |   | V <sub>CC(B)</sub> = 0 V; V <sub>CC(A)</sub> = 5.5 V   | -2               | -   | -4                | -   | μA   |
|                  |   | V <sub>CC(B)</sub> = 5.5 V; V <sub>CC(A)</sub> = 0 V   | -                | 15  | -                 | 20  | μA   |
| ΔI <sub>CC</sub> | additional supply current   | A plus B port (I <sub>CC(A)</sub> + I <sub>CC(B)</sub> ); I <sub>O</sub> = 0 A; V <sub>I</sub> = 0 V or V <sub>CCI</sub> |                  |     |                   |     |      |
|                  |   | V <sub>CC(A)</sub> , V <sub>CC(B)</sub> = 1.2 V to 5.5 V   | -                | 25  | -                 | 30  | μA   |
|                  |   | per input; V <sub>CC(A)</sub> , V <sub>CC(B)</sub> = 3.0 V to 5.5 V  |                  |     |                   |     |      |
|                  |   | DIR and OE input; DIR or OE input at V <sub>CC(A)</sub> - 0.6 V; A port at V <sub>CC(A)</sub> or GND; B port = open      | -                | 50  | -                 | 75  | μA   |
|                  | A port; A port at V <sub>CC(A)</sub> - 0.6 V; DIR at V <sub>CC(A)</sub> ; B port = open [4] | -  | 50               | -   | 75                | μA  |      |
|                  | B port; B port at V <sub>CC(B)</sub> - 0.6 V; DIR at GND; A port = open [4]                 | -  | 50               | -   | 75                | μA  |      |

- [1] V<sub>CCI</sub> is the supply voltage associated with the data input port.
- [2] V<sub>CCO</sub> is the supply voltage associated with the output port.
- [3] To guarantee the node switches, an external driver must source/sink at least I<sub>BHLO</sub> / I<sub>BHHO</sub> when the input is in the range V<sub>IL</sub> to V<sub>IH</sub>.
- [4] For non bus hold parts only (74LVC8T245).

## 10. Dynamic characteristics

Table 8. Typical dynamic characteristics at V<sub>CC(A)</sub> = 1.2 V and T<sub>amb</sub> = 25 °C

Voltages are referenced to GND (ground = 0 V); for test circuit see Fig. 8; for wave forms see Fig. 6 and Fig. 7. [1]

| Symbol           | Parameter         | Conditions | V <sub>CC(B)</sub> |       |       |       |       |       | Unit |
|------------------|-------------------|------------|--------------------|-------|-------|-------|-------|-------|------|
|                  |                   |            | 1.2 V              | 1.5 V | 1.8 V | 2.5 V | 3.3 V | 5.0 V |      |
| t <sub>pd</sub>  | propagation delay | An to Bn   | 11.0               | 8.5   | 7.4   | 6.2   | 5.7   | 5.4   | ns   |
|                  |                   | Bn to An   | 11.0               | 10.0  | 9.5   | 9.1   | 8.9   | 8.9   | ns   |
| t <sub>dis</sub> | disable time      | OE to An   | 9.5                | 9.5   | 9.5   | 9.5   | 9.5   | 9.5   | ns   |
|                  |                   | OE to Bn   | 10.2               | 8.2   | 7.8   | 6.7   | 7.3   | 6.4   | ns   |
| t <sub>en</sub>  | enable time       | OE to An   | 13.5               | 13.5  | 13.5  | 13.5  | 13.5  | 13.5  | ns   |
|                  |                   | OE to Bn   | 13.6               | 10.3  | 8.9   | 7.5   | 7.1   | 7.0   | ns   |

- [1] t<sub>pd</sub> is the same as t<sub>PLH</sub> and t<sub>PHL</sub>; t<sub>dis</sub> is the same as t<sub>PLZ</sub> and t<sub>PHZ</sub>; t<sub>en</sub> is the same as t<sub>PZL</sub> and t<sub>PZH</sub>.

**Table 9. Typical dynamic characteristics at  $V_{CC(B)} = 1.2\text{ V}$  and  $T_{amb} = 25\text{ °C}$** 

Voltages are referenced to GND (ground = 0 V); for test circuit see Fig. 8; for wave forms see Fig. 6 and Fig. 7. [1]

| Symbol    | Parameter         | Conditions            | $V_{CC(A)}$ |       |       |       |       | Unit |       |
|-----------|-------------------|-----------------------|-------------|-------|-------|-------|-------|------|-------|
|           |                   |                       | 1.2 V       | 1.5 V | 1.8 V | 2.5 V | 3.3 V |      | 5.0 V |
| $t_{pd}$  | propagation delay | An to Bn              | 11.0        | 10.0  | 9.5   | 9.1   | 8.9   | 8.8  | ns    |
|           |                   | Bn to An              | 11.0        | 8.5   | 7.3   | 6.2   | 5.7   | 5.4  | ns    |
| $t_{dis}$ | disable time      | $\overline{OE}$ to An | 9.5         | 6.8   | 5.4   | 3.8   | 4.1   | 3.1  | ns    |
|           |                   | $\overline{OE}$ to Bn | 10.2        | 9.1   | 8.6   | 8.1   | 7.8   | 7.8  | ns    |
| $t_{en}$  | enable time       | $\overline{OE}$ to An | 13.5        | 9.0   | 6.9   | 4.8   | 3.8   | 3.2  | ns    |
|           |                   | $\overline{OE}$ to Bn | 13.6        | 12.5  | 12.0  | 11.5  | 11.4  | 11.4 | ns    |

[1]  $t_{pd}$  is the same as  $t_{PLH}$  and  $t_{PHL}$ ;  $t_{dis}$  is the same as  $t_{PLZ}$  and  $t_{PHZ}$ ;  $t_{en}$  is the same as  $t_{PZL}$  and  $t_{PZH}$ .

**Table 10. Typical power dissipation capacitance at  $V_{CC(A)} = V_{CC(B)}$  and  $T_{amb} = 25\text{ °C}$** 

Voltages are referenced to GND (ground = 0 V). [1] [2]

| Symbol   | Parameter                     | Conditions  | $V_{CC(A)}$ and $V_{CC(B)}$ |       |       |       | Unit |
|----------|-------------------------------|---|-----------------------------|-------|-------|-------|------|
|          |                               |   | 1.8 V                       | 2.5 V | 3.3 V | 5.0 V |      |
| $C_{PD}$ | power dissipation capacitance | A port: (direction A to B);<br>B port: (direction B to A) | 1                           | 1     | 1     | 2     | pF   |
|          |                               | A port: (direction B to A);<br>B port: (direction A to B) | 13                          | 13    | 13    | 13    | pF   |

[1]  $C_{PD}$  is used to determine the dynamic power dissipation ( $P_D$  in  $\mu\text{W}$ ).

$$P_D = C_{PD} \times V_{CC}^2 \times f_i \times N + \Sigma(C_L \times V_{CC}^2 \times f_o) \text{ where:}$$

$f_i$  = input frequency in MHz;

$f_o$  = output frequency in MHz;

$C_L$  = load capacitance in pF;

$V_{CC}$  = supply voltage in V;

$N$  = number of inputs switching;

$\Sigma(C_L \times V_{CC}^2 \times f_o)$  = sum of the outputs.

[2]  $f_i = 10\text{ MHz}$ ;  $V_i = \text{GND to } V_{CC}$ ;  $t_r = t_f = 1\text{ ns}$ ;  $C_L = 0\text{ pF}$ ;  $R_L = \infty\ \Omega$ .

Table 11. Dynamic characteristics for temperature range -40 °C to +85 °C

Voltages are referenced to GND (ground = 0 V); for test circuit see Fig. 8; for waveforms see Fig. 6 and Fig. 7. [1]

| Symbol   | Parameter         | Conditions            | $V_{CC(B)}$   |      |                |      |               |      |               |      |               |      | Unit |
|--|-------------------|-----------------------|---------------|------|----------------|------|---------------|------|---------------|------|---------------|------|------|
|  |                   |                       | 1.5 V ± 0.1 V |      | 1.8 V ± 0.15 V |      | 2.5 V ± 0.2 V |      | 3.3 V ± 0.3 V |      | 5.0 V ± 0.5 V |      |      |
|  |                   |                       | Min           | Max  | Min            | Max  | Min           | Max  | Min           | Max  | Min           | Max  |      |
| <b><math>V_{CC(A)} = 1.5 \text{ V} \pm 0.1 \text{ V}</math></b>  |                   |                       |               |      |                |      |               |      |               |      |               |      |      |
| $t_{pd}$   | propagation delay | An to Bn              | 1.7           | 27   | 1.7            | 23   | 1.3           | 18   | 1.0           | 15   | 0.8           | 13   | ns   |
|  |                   | Bn to An              | 0.9           | 27   | 0.9            | 25   | 0.8           | 23   | 0.7           | 23   | 0.7           | 22   | ns   |
| $t_{dis}$  | disable time      | $\overline{OE}$ to An | 1.5           | 30   | 1.5            | 30   | 1.5           | 30   | 1.5           | 30   | 1.4           | 30   | ns   |
|  |                   | $\overline{OE}$ to Bn | 2.4           | 34   | 2.4            | 33   | 1.9           | 15   | 1.7           | 14   | 1.3           | 12   | ns   |
| $t_{en}$   | enable time       | $\overline{OE}$ to An | 0.4           | 34   | 0.4            | 34   | 0.4           | 34   | 0.4           | 34   | 0.4           | 34   | ns   |
|  |                   | $\overline{OE}$ to Bn | 1.8           | 36   | 1.8            | 34   | 1.5           | 18   | 1.2           | 15   | 0.9           | 13   | ns   |
| <b><math>V_{CC(A)} = 1.8 \text{ V} \pm 0.15 \text{ V}</math></b> |                   |                       |               |      |                |      |               |      |               |      |               |      |      |
| $t_{pd}$   | propagation delay | An to Bn              | 1.7           | 25   | 1.7            | 21.9 | 1.3           | 9.2  | 1.0           | 7.4  | 0.8           | 7.1  | ns   |
|  |                   | Bn to An              | 0.9           | 23   | 0.9            | 23.8 | 0.8           | 23.6 | 0.7           | 23.4 | 0.7           | 23.4 | ns   |
| $t_{dis}$  | disable time      | $\overline{OE}$ to An | 1.5           | 30   | 1.5            | 29.6 | 1.5           | 29.4 | 1.5           | 29.3 | 1.4           | 29.2 | ns   |
|  |                   | $\overline{OE}$ to Bn | 2.4           | 33   | 2.4            | 32.2 | 1.9           | 13.1 | 1.7           | 12.0 | 1.3           | 10.3 | ns   |
| $t_{en}$   | enable time       | $\overline{OE}$ to An | 0.4           | 24   | 0.4            | 24.0 | 0.4           | 23.8 | 0.4           | 23.7 | 0.4           | 23.7 | ns   |
|  |                   | $\overline{OE}$ to Bn | 1.8           | 34   | 1.8            | 32.0 | 1.5           | 16.0 | 1.2           | 12.6 | 0.9           | 10.8 | ns   |
| <b><math>V_{CC(A)} = 2.5 \text{ V} \pm 0.2 \text{ V}</math></b>  |                   |                       |               |      |                |      |               |      |               |      |               |      |      |
| $t_{pd}$   | propagation delay | An to Bn              | 1.5           | 23   | 1.5            | 21.4 | 1.2           | 9.0  | 0.8           | 6.2  | 0.6           | 4.8  | ns   |
|  |                   | Bn to An              | 1.2           | 18   | 1.2            | 9.3  | 1.0           | 9.1  | 1.0           | 8.9  | 0.9           | 8.8  | ns   |
| $t_{dis}$  | disable time      | $\overline{OE}$ to An | 1.4           | 9.0  | 1.4            | 9.0  | 1.4           | 9.0  | 1.4           | 9.0  | 1.4           | 9.0  | ns   |
|  |                   | $\overline{OE}$ to Bn | 2.3           | 31   | 2.3            | 29.6 | 1.8           | 11.0 | 1.7           | 9.3  | 0.9           | 6.9  | ns   |
| $t_{en}$   | enable time       | $\overline{OE}$ to An | 1.0           | 10.9 | 1.0            | 10.9 | 1.0           | 10.9 | 1.0           | 10.9 | 1.0           | 10.9 | ns   |
|  |                   | $\overline{OE}$ to Bn | 1.7           | 32   | 1.7            | 28.2 | 1.5           | 12.9 | 1.2           | 9.4  | 1.0           | 6.9  | ns   |
| <b><math>V_{CC(A)} = 3.3 \text{ V} \pm 0.3 \text{ V}</math></b>  |                   |                       |               |      |                |      |               |      |               |      |               |      |      |
| $t_{pd}$   | propagation delay | An to Bn              | 1.5           | 23   | 1.5            | 21.2 | 1.1           | 8.8  | 0.8           | 6.3  | 0.5           | 4.4  | ns   |
|  |                   | Bn to An              | 0.8           | 15   | 0.8            | 7.2  | 0.8           | 6.2  | 0.7           | 6.1  | 0.6           | 6.0  | ns   |
| $t_{dis}$  | disable time      | $\overline{OE}$ to An | 1.6           | 8.2  | 1.6            | 8.2  | 1.6           | 8.2  | 1.6           | 8.2  | 1.6           | 8.2  | ns   |
|  |                   | $\overline{OE}$ to Bn | 2.1           | 30   | 2.1            | 29.0 | 1.7           | 10.3 | 1.5           | 8.6  | 0.8           | 6.3  | ns   |
| $t_{en}$   | enable time       | $\overline{OE}$ to An | 0.8           | 8.1  | 0.8            | 8.1  | 0.8           | 8.1  | 0.8           | 8.1  | 0.8           | 8.1  | ns   |
|  |                   | $\overline{OE}$ to Bn | 1.8           | 31   | 1.8            | 27.7 | 1.4           | 12.4 | 1.1           | 8.5  | 0.9           | 6.4  | ns   |
| <b><math>V_{CC(A)} = 5.0 \text{ V} \pm 0.5 \text{ V}</math></b>  |                   |                       |               |      |                |      |               |      |               |      |               |      |      |
| $t_{pd}$   | propagation delay | An to Bn              | 1.5           | 22   | 1.5            | 21.4 | 1.0           | 8.8  | 0.7           | 6.0  | 0.4           | 4.2  | ns   |
|  |                   | Bn to An              | 0.7           | 13   | 0.7            | 7.0  | 0.4           | 4.8  | 0.3           | 4.5  | 0.3           | 4.3  | ns   |
| $t_{dis}$  | disable time      | $\overline{OE}$ to An | 0.3           | 5.4  | 0.3            | 5.4  | 0.3           | 5.4  | 0.3           | 5.4  | 0.3           | 5.4  | ns   |
|  |                   | $\overline{OE}$ to Bn | 2.0           | 30   | 2.0            | 28.7 | 1.6           | 9.7  | 1.4           | 8.0  | 0.7           | 5.7  | ns   |
| $t_{en}$   | enable time       | $\overline{OE}$ to An | 0.7           | 6.4  | 0.7            | 6.4  | 0.7           | 6.4  | 0.7           | 6.4  | 0.7           | 6.4  | ns   |
|  |                   | $\overline{OE}$ to Bn | 1.5           | 31   | 1.5            | 27.6 | 1.3           | 11.4 | 1.0           | 8.1  | 0.9           | 6.0  | ns   |

[1]  $t_{pd}$  is the same as  $t_{PLH}$  and  $t_{PHL}$ ;  $t_{dis}$  is the same as  $t_{PLZ}$  and  $t_{PHZ}$ ;  $t_{en}$  is the same as  $t_{PZL}$  and  $t_{PZH}$ .

Table 12. Dynamic characteristics for temperature range -40 °C to +125 °C

Voltages are referenced to GND (ground = 0 V); for test circuit see Fig. 8; for waveforms see Fig. 6 and Fig. 7. [1]

| Symbol   | Parameter         | Conditions            | $V_{CC(B)}$   |      |                |      |               |      |               |      |               |      | Unit |
|--|-------------------|-----------------------|---------------|------|----------------|------|---------------|------|---------------|------|---------------|------|------|
|  |                   |                       | 1.5 V ± 0.1 V |      | 1.8 V ± 0.15 V |      | 2.5 V ± 0.2 V |      | 3.3 V ± 0.3 V |      | 5.0 V ± 0.5 V |      |      |
|  |                   |                       | Min           | Max  | Min            | Max  | Min           | Max  | Min           | Max  | Min           | Max  |      |
| <b><math>V_{CC(A)} = 1.5 \text{ V} \pm 0.1 \text{ V}</math></b>  |                   |                       |               |      |                |      |               |      |               |      |               |      |      |
| $t_{pd}$   | propagation delay | An to Bn              | 1.7           | 32   | 1.7            | 27   | 1.3           | 21   | 1.0           | 18   | 0.8           | 16   | ns   |
|  |                   | Bn to An              | 0.9           | 32   | 0.9            | 30   | 0.8           | 28   | 0.7           | 28   | 0.7           | 26   | ns   |
| $t_{dis}$  | disable time      | $\overline{OE}$ to An | 1.5           | 34   | 1.5            | 34   | 1.5           | 34   | 1.5           | 34   | 1.4           | 34   | ns   |
|  |                   | $\overline{OE}$ to Bn | 2.4           | 41   | 2.4            | 40   | 1.9           | 18   | 1.7           | 17   | 1.3           | 15   | ns   |
| $t_{en}$   | enable time       | $\overline{OE}$ to An | 0.4           | 40   | 0.4            | 40   | 0.4           | 40   | 0.4           | 40   | 0.4           | 40   | ns   |
|  |                   | $\overline{OE}$ to Bn | 1.8           | 43   | 1.8            | 41   | 1.5           | 22   | 1.2           | 18   | 0.9           | 16   | ns   |
| <b><math>V_{CC(A)} = 1.8 \text{ V} \pm 0.15 \text{ V}</math></b> |                   |                       |               |      |                |      |               |      |               |      |               |      |      |
| $t_{pd}$   | propagation delay | An to Bn              | 1.7           | 30   | 1.7            | 25.9 | 1.3           | 13.2 | 1.0           | 11.4 | 0.8           | 11.1 | ns   |
|  |                   | Bn to An              | 0.9           | 27   | 0.9            | 28.8 | 0.8           | 27.6 | 0.7           | 27.4 | 0.7           | 27.4 | ns   |
| $t_{dis}$  | disable time      | $\overline{OE}$ to An | 1.5           | 34   | 1.5            | 33.6 | 1.5           | 33.4 | 1.5           | 33.3 | 1.4           | 33.2 | ns   |
|  |                   | $\overline{OE}$ to Bn | 2.4           | 40   | 2.4            | 36.2 | 1.9           | 17.1 | 1.7           | 16.0 | 1.3           | 14.3 | ns   |
| $t_{en}$   | enable time       | $\overline{OE}$ to An | 0.4           | 28   | 0.4            | 28   | 0.4           | 27.8 | 0.4           | 27.7 | 0.4           | 27.7 | ns   |
|  |                   | $\overline{OE}$ to Bn | 1.8           | 41   | 1.8            | 40   | 1.5           | 20   | 1.2           | 16.6 | 0.9           | 14.8 | ns   |
| <b><math>V_{CC(A)} = 2.5 \text{ V} \pm 0.2 \text{ V}</math></b>  |                   |                       |               |      |                |      |               |      |               |      |               |      |      |
| $t_{pd}$   | propagation delay | An to Bn              | 1.5           | 28   | 1.5            | 25.4 | 1.2           | 13   | 0.8           | 10.2 | 0.6           | 8.8  | ns   |
|  |                   | Bn to An              | 1.2           | 23   | 1.2            | 13.3 | 1.0           | 13.1 | 1.0           | 12.9 | 0.9           | 12.8 | ns   |
| $t_{dis}$  | disable time      | $\overline{OE}$ to An | 1.4           | 13   | 1.4            | 13   | 1.4           | 13   | 1.4           | 13   | 1.4           | 13   | ns   |
|  |                   | $\overline{OE}$ to Bn | 2.3           | 37   | 2.3            | 33.6 | 1.8           | 15   | 1.7           | 14.3 | 0.9           | 10.9 | ns   |
| $t_{en}$   | enable time       | $\overline{OE}$ to An | 1.0           | 17.2 | 1.0            | 17.2 | 1.0           | 17.3 | 1.0           | 17.2 | 1.0           | 17.3 | ns   |
|  |                   | $\overline{OE}$ to Bn | 1.7           | 38   | 1.7            | 32.2 | 1.5           | 18.1 | 1.2           | 14.1 | 1.0           | 11.2 | ns   |
| <b><math>V_{CC(A)} = 3.3 \text{ V} \pm 0.3 \text{ V}</math></b>  |                   |                       |               |      |                |      |               |      |               |      |               |      |      |
| $t_{pd}$   | propagation delay | An to Bn              | 1.5           | 28   | 1.5            | 25.2 | 1.1           | 12.8 | 0.8           | 10.3 | 0.5           | 10.4 | ns   |
|  |                   | Bn to An              | 0.8           | 18   | 0.8            | 11.2 | 0.8           | 10.2 | 0.7           | 10.1 | 0.6           | 10   | ns   |
| $t_{dis}$  | disable time      | $\overline{OE}$ to An | 1.6           | 12.2 | 1.6            | 12.2 | 1.6           | 12.2 | 1.6           | 12.2 | 1.6           | 12.2 | ns   |
|  |                   | $\overline{OE}$ to Bn | 2.1           | 36   | 2.1            | 33   | 1.7           | 14.3 | 1.5           | 12.6 | 0.8           | 10.3 | ns   |
| $t_{en}$   | enable time       | $\overline{OE}$ to An | 0.8           | 14.1 | 0.8            | 14.1 | 0.8           | 13.6 | 0.8           | 13.2 | 0.8           | 13.6 | ns   |
|  |                   | $\overline{OE}$ to Bn | 1.8           | 37   | 1.8            | 31.7 | 1.4           | 18.4 | 1.1           | 12.9 | 0.9           | 10.9 | ns   |
| <b><math>V_{CC(A)} = 5.0 \text{ V} \pm 0.5 \text{ V}</math></b>  |                   |                       |               |      |                |      |               |      |               |      |               |      |      |
| $t_{pd}$   | propagation delay | An to Bn              | 1.5           | 26   | 1.5            | 25.4 | 1.0           | 12.8 | 0.7           | 10   | 0.4           | 8.2  | ns   |
|  |                   | Bn to An              | 0.7           | 16   | 0.7            | 11   | 0.4           | 8.8  | 0.3           | 8.5  | 0.3           | 8.3  | ns   |
| $t_{dis}$  | disable time      | $\overline{OE}$ to An | 0.3           | 9.4  | 0.3            | 9.4  | 0.3           | 9.4  | 0.3           | 9.4  | 0.3           | 9.4  | ns   |
|  |                   | $\overline{OE}$ to Bn | 2.0           | 36   | 2.0            | 32.7 | 1.6           | 13.7 | 1.4           | 12   | 0.7           | 9.7  | ns   |
| $t_{en}$   | enable time       | $\overline{OE}$ to An | 0.7           | 10.9 | 0.7            | 10.9 | 0.7           | 10.9 | 0.7           | 10.9 | 0.7           | 10.9 | ns   |
|  |                   | $\overline{OE}$ to Bn | 1.5           | 37   | 1.5            | 31.6 | 1.3           | 18.4 | 1.0           | 13.7 | 0.9           | 10.7 | ns   |

[1]  $t_{pd}$  is the same as  $t_{PLH}$  and  $t_{PHL}$ ;  $t_{dis}$  is the same as  $t_{PLZ}$  and  $t_{PHZ}$ ;  $t_{en}$  is the same as  $t_{PZL}$  and  $t_{PZH}$ .

10.1. Waveforms and test circuit

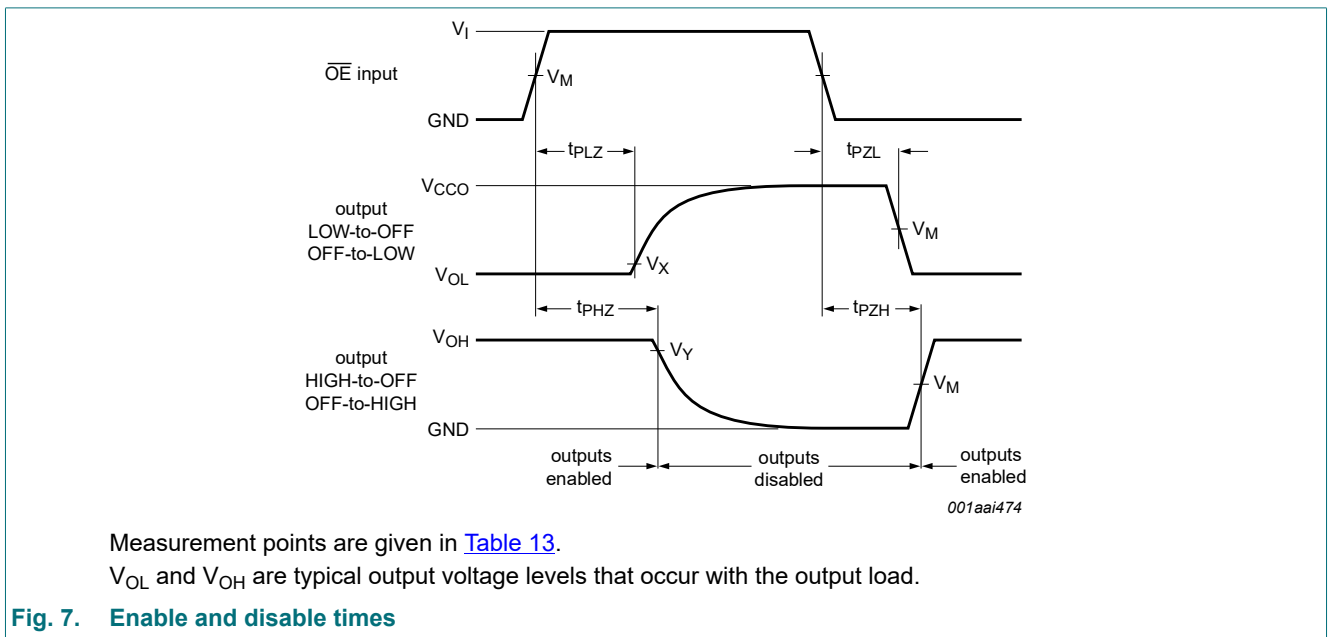
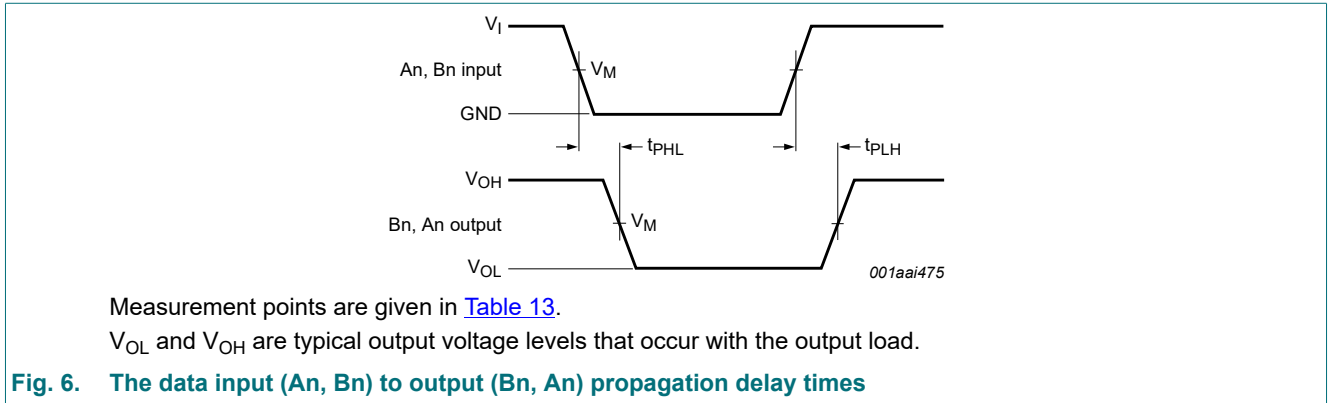
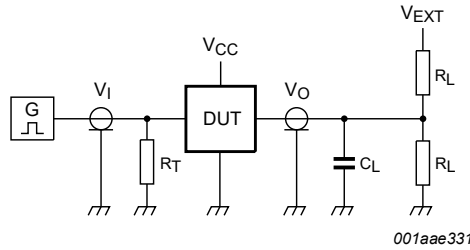
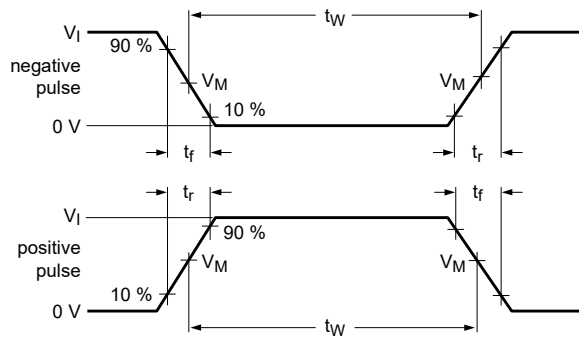

Table 13. Measurement points

| Supply voltage         | Input [1]    | Output [2]   |                   |                   |
|------------------------|--------------|--------------|-------------------|-------------------|
| $V_{CC(A)}, V_{CC(B)}$ | $V_M$        | $V_M$        | $V_X$             | $V_Y$             |
| 1.2 V to 1.6 V         | $0.5V_{CCI}$ | $0.5V_{CCO}$ | $V_{OL} + 0.1 V$  | $V_{OH} - 0.1 V$  |
| 1.65 V to 2.7 V        | $0.5V_{CCI}$ | $0.5V_{CCO}$ | $V_{OL} + 0.15 V$ | $V_{OH} - 0.15 V$ |
| 3.0 V to 5.5 V         | $0.5V_{CCI}$ | $0.5V_{CCO}$ | $V_{OL} + 0.3 V$  | $V_{OH} - 0.3 V$  |

[1]  $V_{CCI}$  is the supply voltage associated with the data input port.  
 [2]  $V_{CCO}$  is the supply voltage associated with the output port.



Test data is given in [Table 14](#).

$R_L$  = Load resistance.

$C_L$  = Load capacitance including jig and probe capacitance.

$R_T$  = Termination resistance.

$V_{EXT}$  = External voltage for measuring switching times.

**Fig. 8. Test circuit for measuring switching times**

**Table 14. Test data**

| Supply voltage         | Input     |                         | Load  |              | $V_{EXT}$          |                    |                        |
|------------------------|-----------|-------------------------|-------|--------------|--------------------|--------------------|------------------------|
| $V_{CC(A)}, V_{CC(B)}$ | $V_I$ [1] | $\Delta t/\Delta V$ [2] | $C_L$ | $R_L$        | $t_{PLH}, t_{PHL}$ | $t_{PZH}, t_{PHZ}$ | $t_{PZL}, t_{PLZ}$ [3] |
| 1.2 V to 5.5 V         | $V_{CCI}$ | $\leq 1.0 \text{ ns/V}$ | 15 pF | 2 k $\Omega$ | open               | GND                | $2V_{CCO}$             |

[1]  $V_{CCI}$  is the supply voltage associated with the data input port.

[2]  $dV/dt \geq 1.0 \text{ V/ns}$ .

[3]  $V_{CCO}$  is the supply voltage associated with the output port.

### 11. Typical propagation delay characteristics

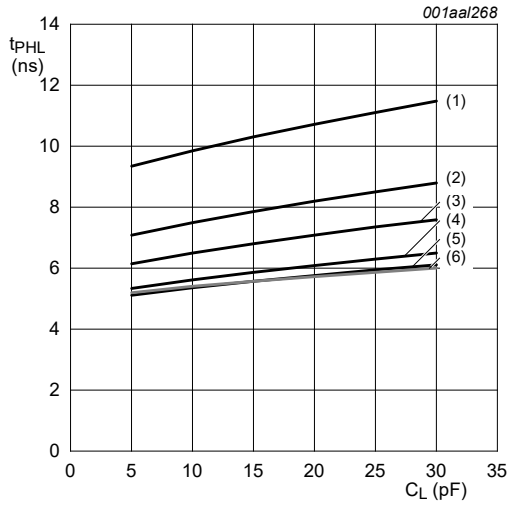

a. HIGH to LOW propagation delay (A to B)

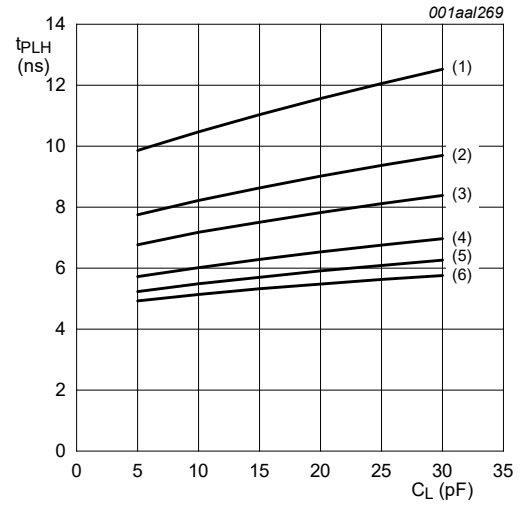

b. LOW to HIGH propagation delay (A to B)

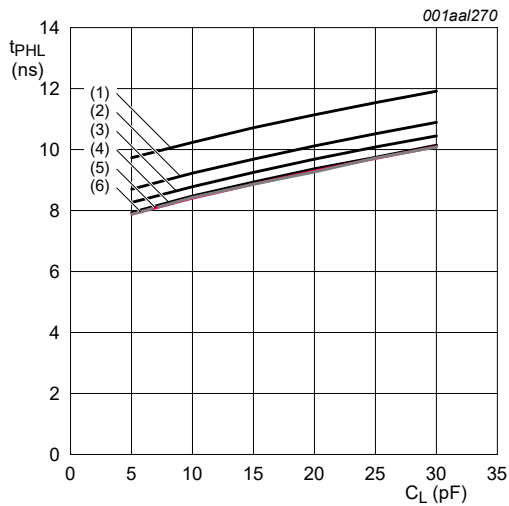

c. HIGH to LOW propagation delay (B to A)

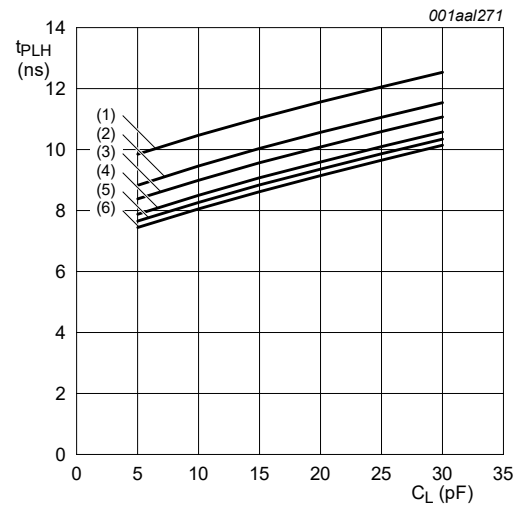

d. LOW to HIGH propagation delay (B to A)

- (1)  $V_{CC(B)} = 1.2\text{ V}$ .
- (2)  $V_{CC(B)} = 1.5\text{ V}$ .
- (3)  $V_{CC(B)} = 1.8\text{ V}$ .
- (4)  $V_{CC(B)} = 2.5\text{ V}$ .
- (5)  $V_{CC(B)} = 3.3\text{ V}$ .
- (6)  $V_{CC(B)} = 5.0\text{ V}$ .

Fig. 9. Typical propagation delay versus load capacitance;  $T_{amb} = 25\text{ }^\circ\text{C}$ ;  $V_{CC(A)} = 1.2\text{ V}$

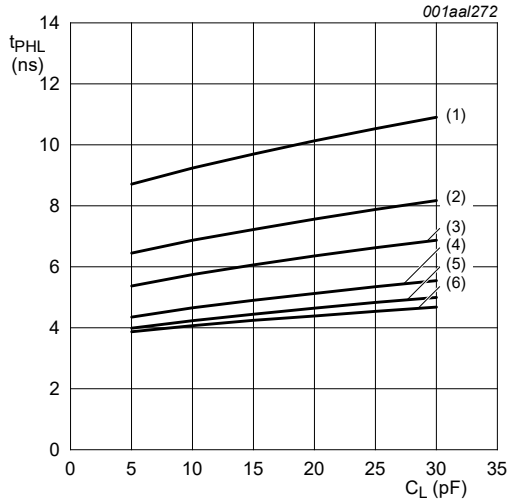

a. HIGH to LOW propagation delay (A to B)

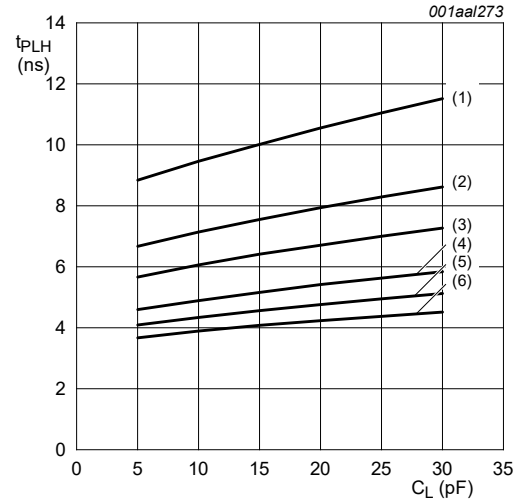

b. LOW to HIGH propagation delay (A to B)

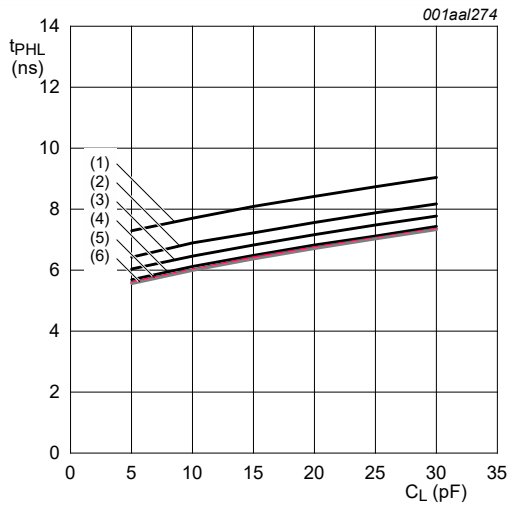

c. HIGH to LOW propagation delay (B to A)

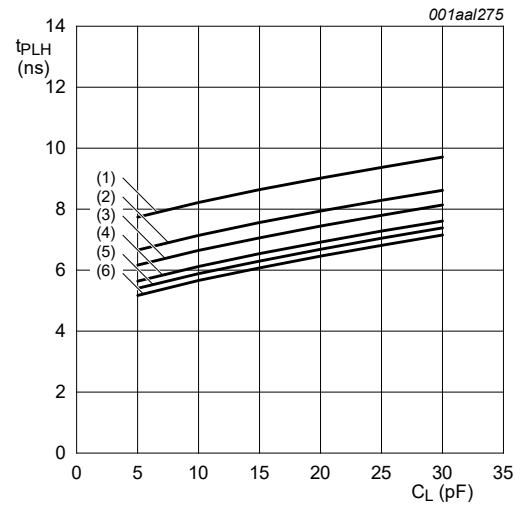

d. LOW to HIGH propagation delay (B to A)

- (1)  $V_{CC(B)} = 1.2\text{ V}$ .
- (2)  $V_{CC(B)} = 1.5\text{ V}$ .
- (3)  $V_{CC(B)} = 1.8\text{ V}$ .
- (4)  $V_{CC(B)} = 2.5\text{ V}$ .
- (5)  $V_{CC(B)} = 3.3\text{ V}$ .
- (6)  $V_{CC(B)} = 5.0\text{ V}$ .

Fig. 10. Typical propagation delay versus load capacitance;  $T_{amb} = 25\text{ }^\circ\text{C}$ ;  $V_{CC(A)} = 1.5\text{ V}$



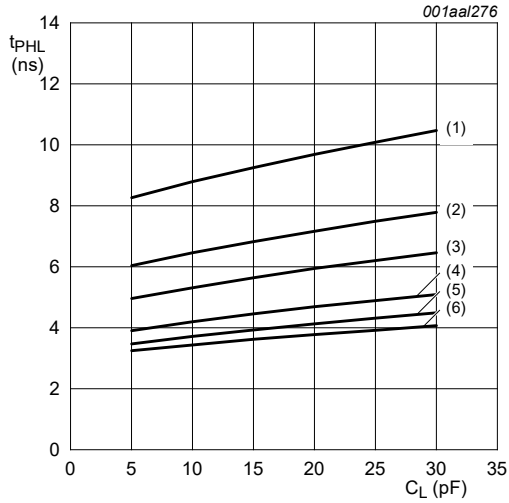

a. HIGH to LOW propagation delay (A to B)

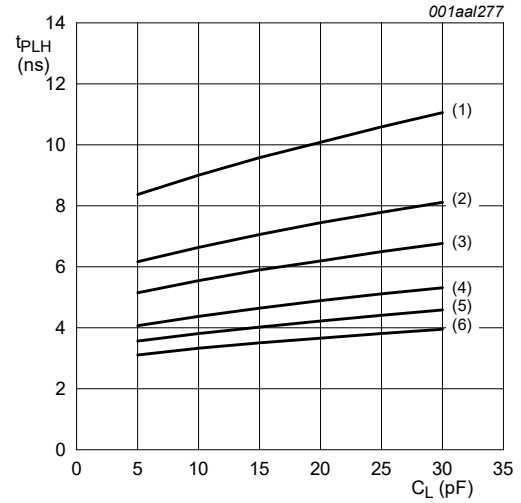

b. LOW to HIGH propagation delay (A to B)

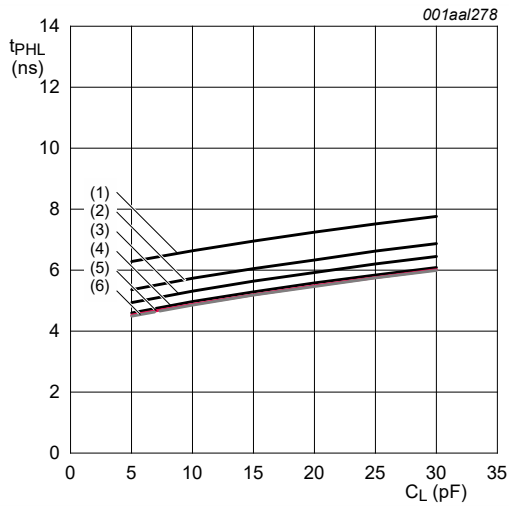

c. HIGH to LOW propagation delay (B to A)

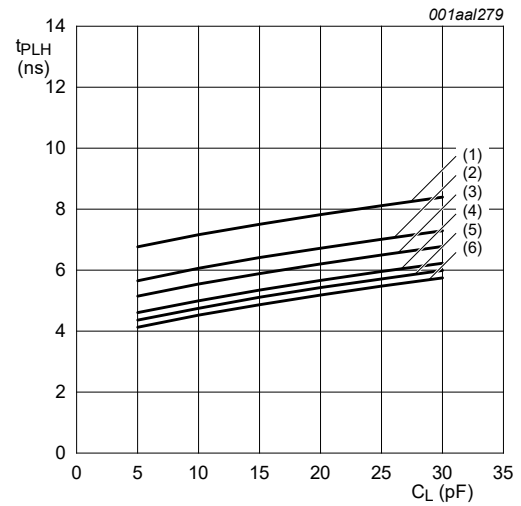

d. LOW to HIGH propagation delay (B to A)

- (1)  $V_{CC(B)} = 1.2\text{ V}$ .
- (2)  $V_{CC(B)} = 1.5\text{ V}$ .
- (3)  $V_{CC(B)} = 1.8\text{ V}$ .
- (4)  $V_{CC(B)} = 2.5\text{ V}$ .
- (5)  $V_{CC(B)} = 3.3\text{ V}$ .
- (6)  $V_{CC(B)} = 5.0\text{ V}$ .

Fig. 11. Typical propagation delay versus load capacitance;  $T_{amb} = 25\text{ }^\circ\text{C}$ ;  $V_{CC(A)} = 1.8\text{ V}$

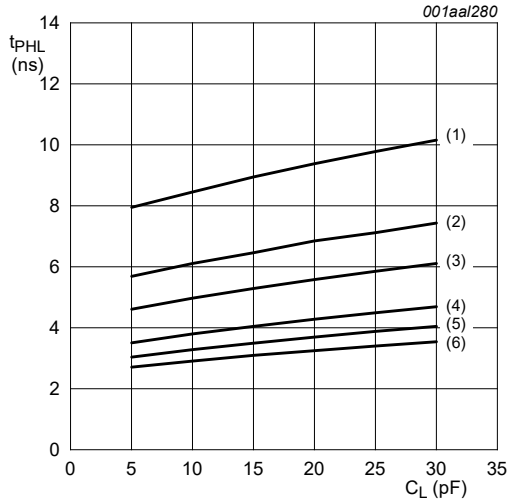

a. HIGH to LOW propagation delay (A to B)

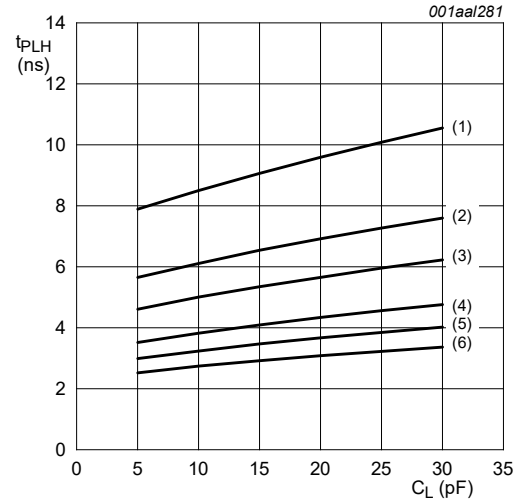

b. LOW to HIGH propagation delay (A to B)

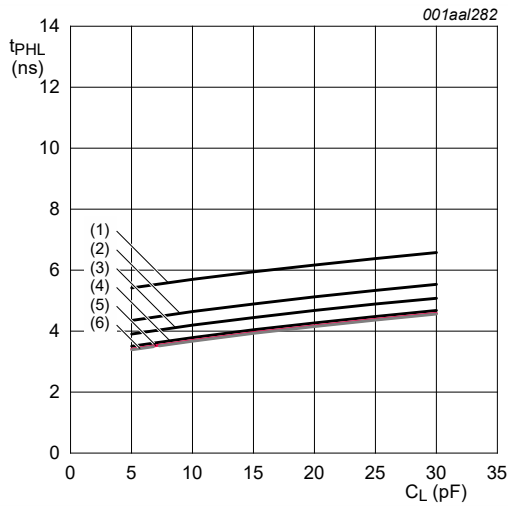

c. HIGH to LOW propagation delay (B to A)

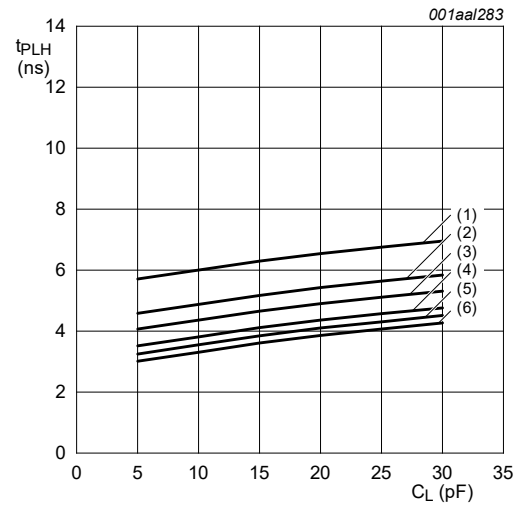

d. LOW to HIGH propagation delay (B to A)

- (1)  $V_{CC(B)} = 1.2\text{ V}$ .
- (2)  $V_{CC(B)} = 1.5\text{ V}$ .
- (3)  $V_{CC(B)} = 1.8\text{ V}$ .
- (4)  $V_{CC(B)} = 2.5\text{ V}$ .
- (5)  $V_{CC(B)} = 3.3\text{ V}$ .
- (6)  $V_{CC(B)} = 5.0\text{ V}$ .

Fig. 12. Typical propagation delay versus load capacitance;  $T_{amb} = 25\text{ }^\circ\text{C}$ ;  $V_{CC(A)} = 2.5\text{ V}$

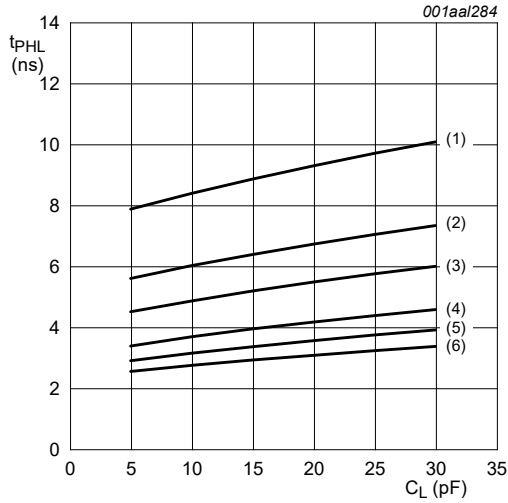

a. HIGH to LOW propagation delay (A to B)

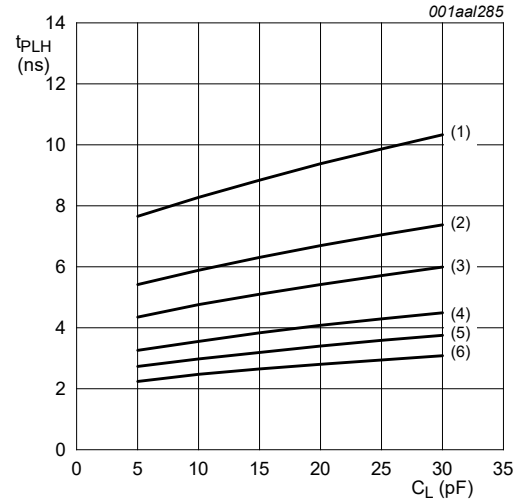

b. LOW to HIGH propagation delay (A to B)

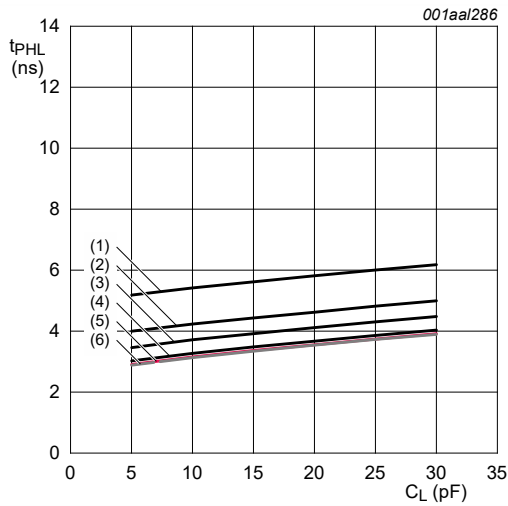

c. HIGH to LOW propagation delay (B to A)

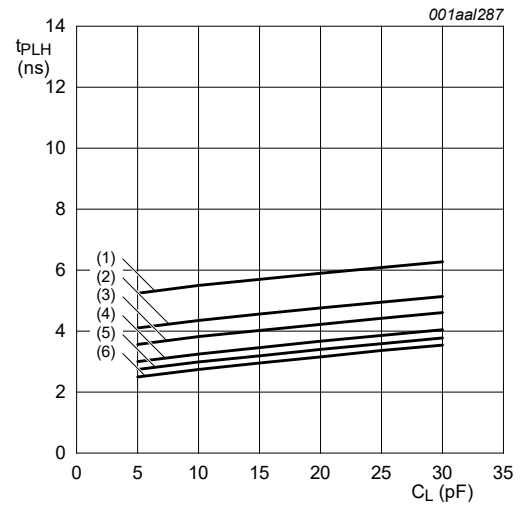

d. LOW to HIGH propagation delay (B to A)

- (1)  $V_{CC(B)} = 1.2\text{ V}$ .
- (2)  $V_{CC(B)} = 1.5\text{ V}$ .
- (3)  $V_{CC(B)} = 1.8\text{ V}$ .
- (4)  $V_{CC(B)} = 2.5\text{ V}$ .
- (5)  $V_{CC(B)} = 3.3\text{ V}$ .
- (6)  $V_{CC(B)} = 5.0\text{ V}$ .

Fig. 13. Typical propagation delay versus load capacitance;  $T_{amb} = 25\text{ }^\circ\text{C}$ ;  $V_{CC(A)} = 3.3\text{ V}$

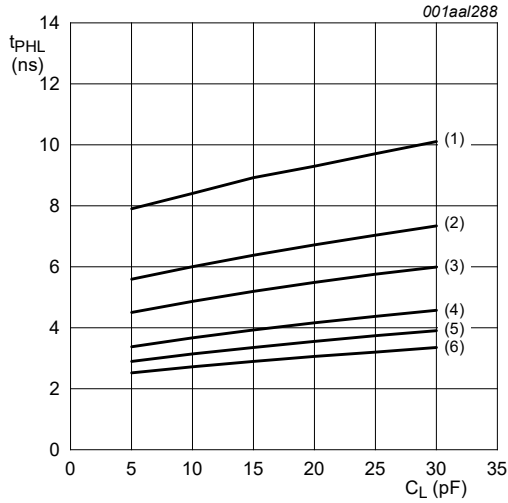

a. HIGH to LOW propagation delay (A to B)

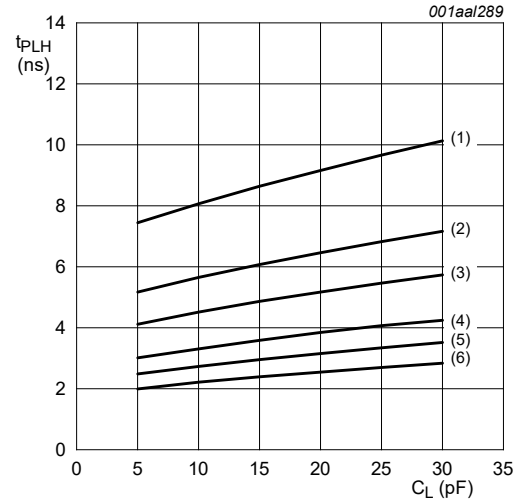

b. LOW to HIGH propagation delay (A to B)

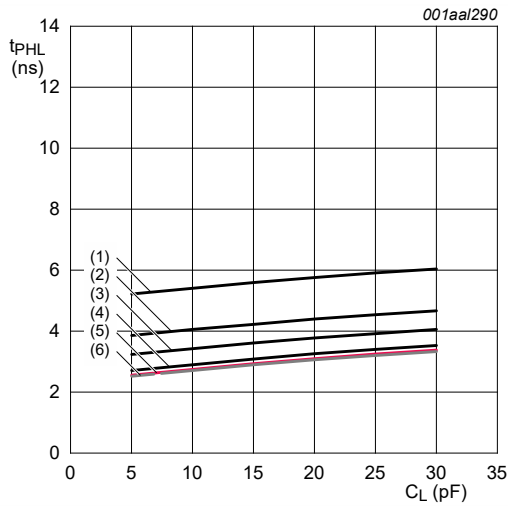

c. HIGH to LOW propagation delay (B to A)

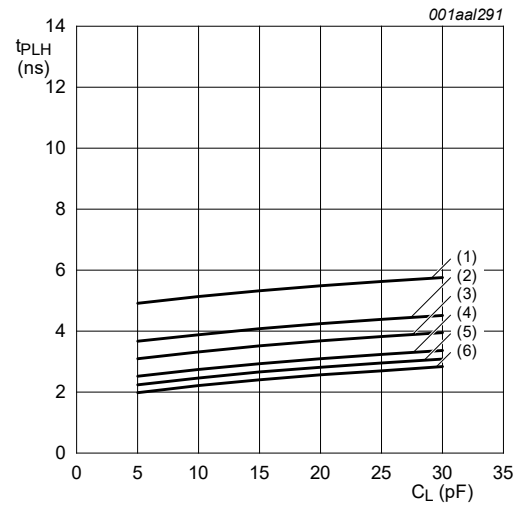

d. LOW to HIGH propagation delay (B to A)

- (1)  $V_{CC(B)} = 1.2 \text{ V}$ .
- (2)  $V_{CC(B)} = 1.5 \text{ V}$ .
- (3)  $V_{CC(B)} = 1.8 \text{ V}$ .
- (4)  $V_{CC(B)} = 2.5 \text{ V}$ .
- (5)  $V_{CC(B)} = 3.3 \text{ V}$ .
- (6)  $V_{CC(B)} = 5.0 \text{ V}$ .

Fig. 14. Typical propagation delay versus load capacitance;  $T_{amb} = 25 \text{ }^\circ\text{C}$ ;  $V_{CC(A)} = 5 \text{ V}$

## 12. Application information

### 12.1. Unidirectional logic level-shifting application

The circuit given in Fig. 15 is an example of the 74LVC8T245; 74LVCH8T245 being used in an unidirectional logic level-shifting application.

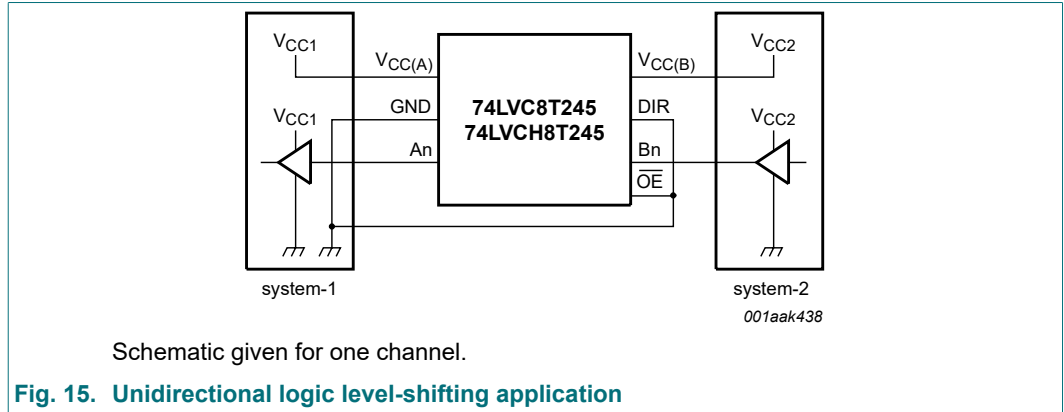

Fig. 15. Unidirectional logic level-shifting application

Table 15. Description unidirectional logic level-shifting application

| Name               | Function         | Description   |
|--------------------|------------------|---|
| V <sub>CC(A)</sub> | V <sub>CC1</sub> | supply voltage of system-1 (1.2 V to 5.5 V)               |
| GND                | GND              | device GND  |
| A                  | OUT              | output level depends on V <sub>CC1</sub> voltage          |
| B                  | IN               | input threshold value depends on V <sub>CC2</sub> voltage |
| DIR                | DIR              | the GND (LOW level) determines B port to A port direction |
| V <sub>CC(B)</sub> | V <sub>CC2</sub> | supply voltage of system-2 (1.2 V to 5.5 V)               |
| $\overline{OE}$    | $\overline{OE}$  | The GND (LOW level) enables the output ports              |

### 12.2. Bidirectional logic level-shifting application

Fig. 16 shows the 74LVC8T245; 74LVCH8T245 being used in a bidirectional logic level-shifting application.

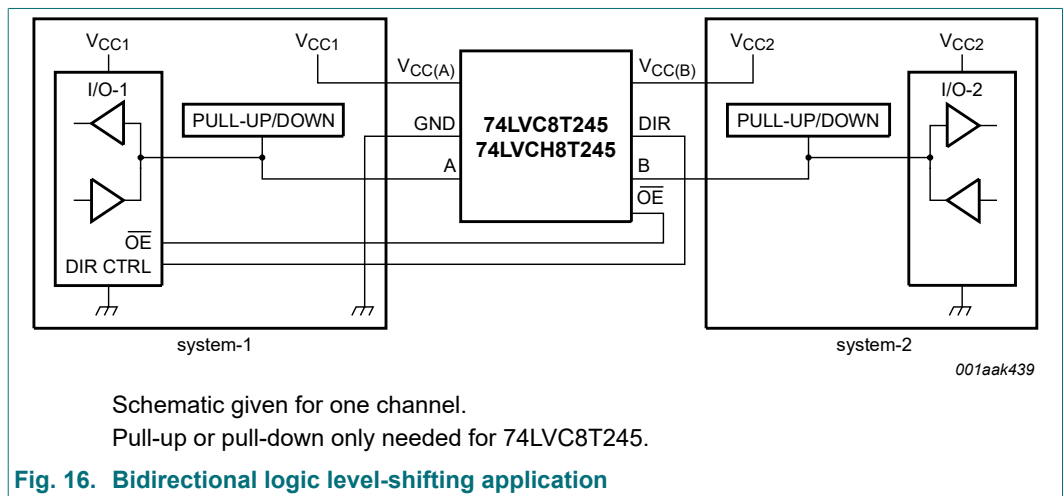

Fig. 16. Bidirectional logic level-shifting application

Table 16 gives a sequence that will illustrate data transmission from system-1 to system-2 and then from system-2 to system-1.

**Table 16. Description bidirectional logic level-shifting application**

*H = HIGH voltage level; L = LOW voltage level; Z = high-impedance OFF-state.*

| State | DIR CTRL | $\overline{OE}$ | I/O-1  | I/O-2  | Description   |
|-------|----------|-----------------|--------|--------|---|
| 1     | H        | L               | output | input  | system-1 data to system-2   |
| 2     | H        | H               | Z      | Z      | system-2 is getting ready to send data to system-1. I/O-1 and I/O-2 are disabled. The bus-line state depends on bus hold. |
| 3     | L        | H               | Z      | Z      | DIR bit is set LOW. I/O-1 and I/O-2 still are disabled. The bus-line state depends on bus hold.                           |
| 4     | L        | L               | input  | output | system-2 data to system-1   |

### 12.3. Power-up considerations

The device is designed such that no special power-up sequence is required other than GND being applied first.

**Table 17. Typical total supply current ( $I_{CC(A)} + I_{CC(B)}$ )**

| $V_{CC(A)}$ | $V_{CC(B)}$ |       |       |       |       | Unit          |
|-------------|-------------|-------|-------|-------|-------|---------------|
|             | 0 V         | 1.8 V | 2.5 V | 3.3 V | 5.0 V |               |
| 0 V         | 0           | < 1   | < 1   | < 1   | < 1   | $\mu\text{A}$ |
| 1.8 V       | < 1         | < 2   | < 2   | < 2   | 2     | $\mu\text{A}$ |
| 2.5 V       | < 1         | < 2   | < 2   | < 2   | < 2   | $\mu\text{A}$ |
| 3.3 V       | < 1         | < 2   | < 2   | < 2   | < 2   | $\mu\text{A}$ |
| 5.0 V       | < 1         | 2     | < 2   | < 2   | < 2   | $\mu\text{A}$ |

13. Package outline

TSSOP24: plastic thin shrink small outline package; 24 leads; body width 4.4 mm

SOT355-1

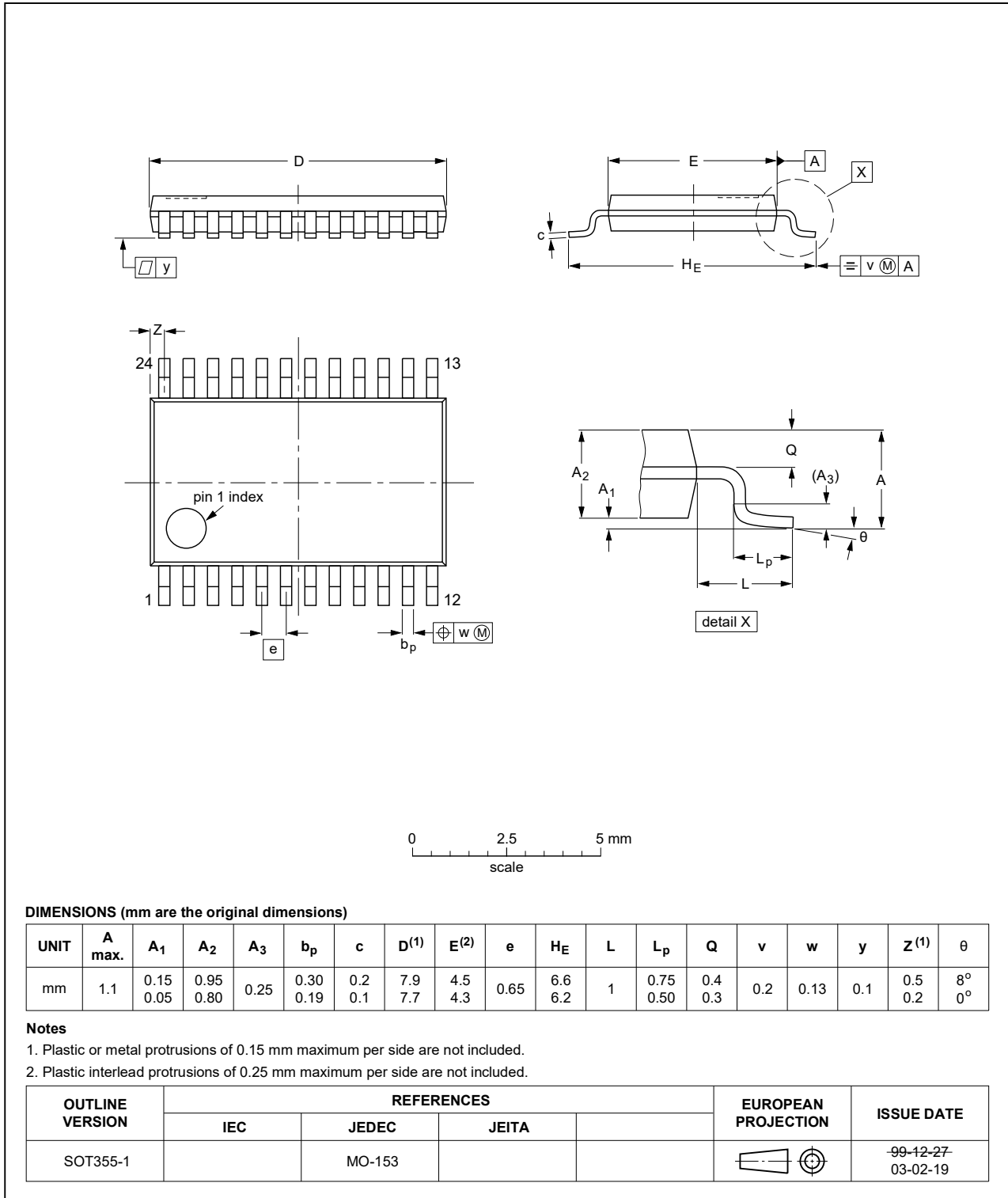

Fig. 17. Package outline SOT355-1 (TSSOP24)

DHVQFN24: plastic dual in-line compatible thermal enhanced very thin quad flat package;  
no leads; 24 terminals; body 3.5 x 5.5 x 0.85 mm

SOT815-1

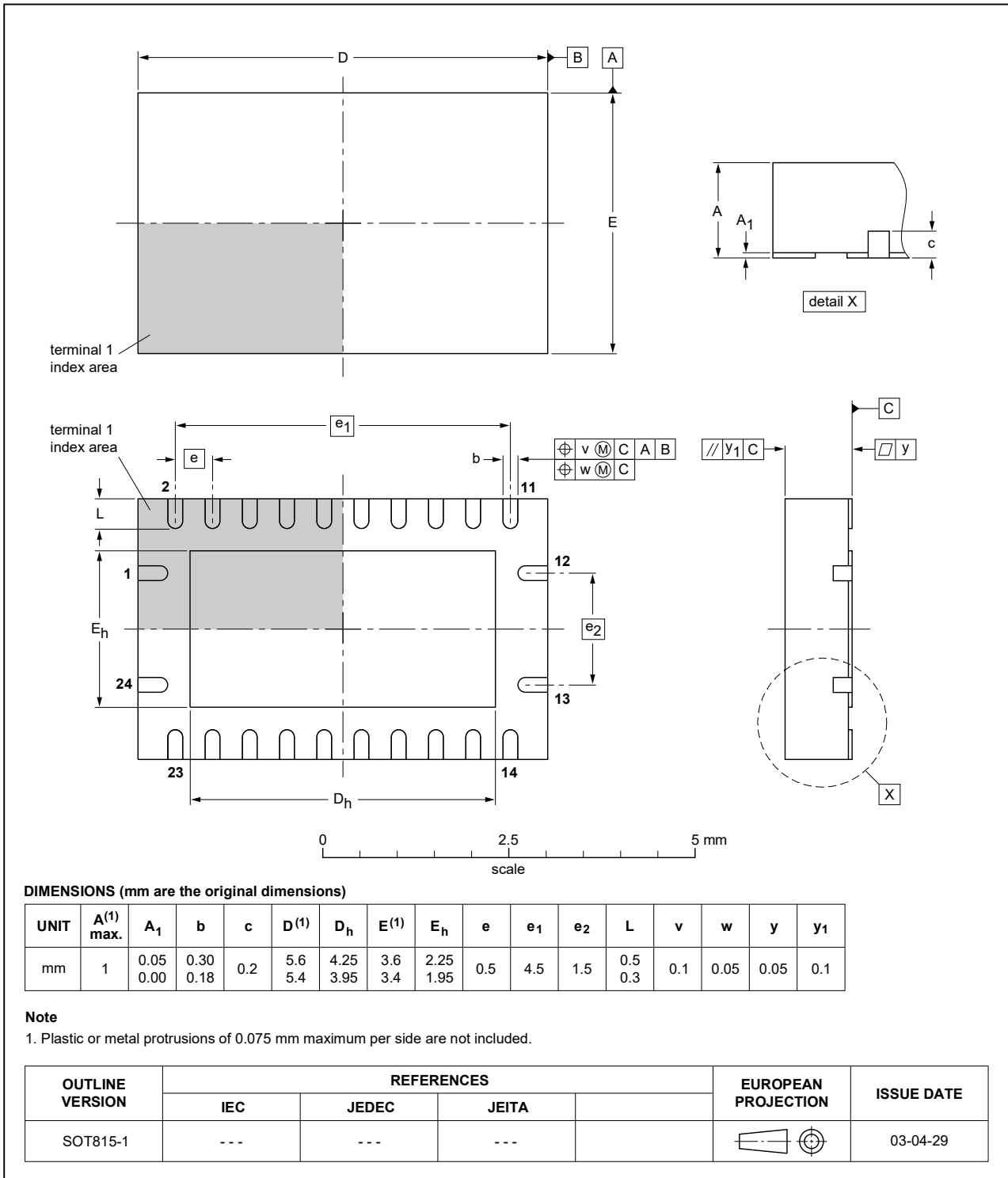

Fig. 18. Package outline SOT815-1 (DHVQFN24)



DHXQFN24: plastic, leadless dual in-line compatible thermal enhanced extreme thin quad flat package; no leads; 24 terminals; 0.4 mm pitch; body 2 mm x 4 mm x 0.48 mm

SOT8024-1

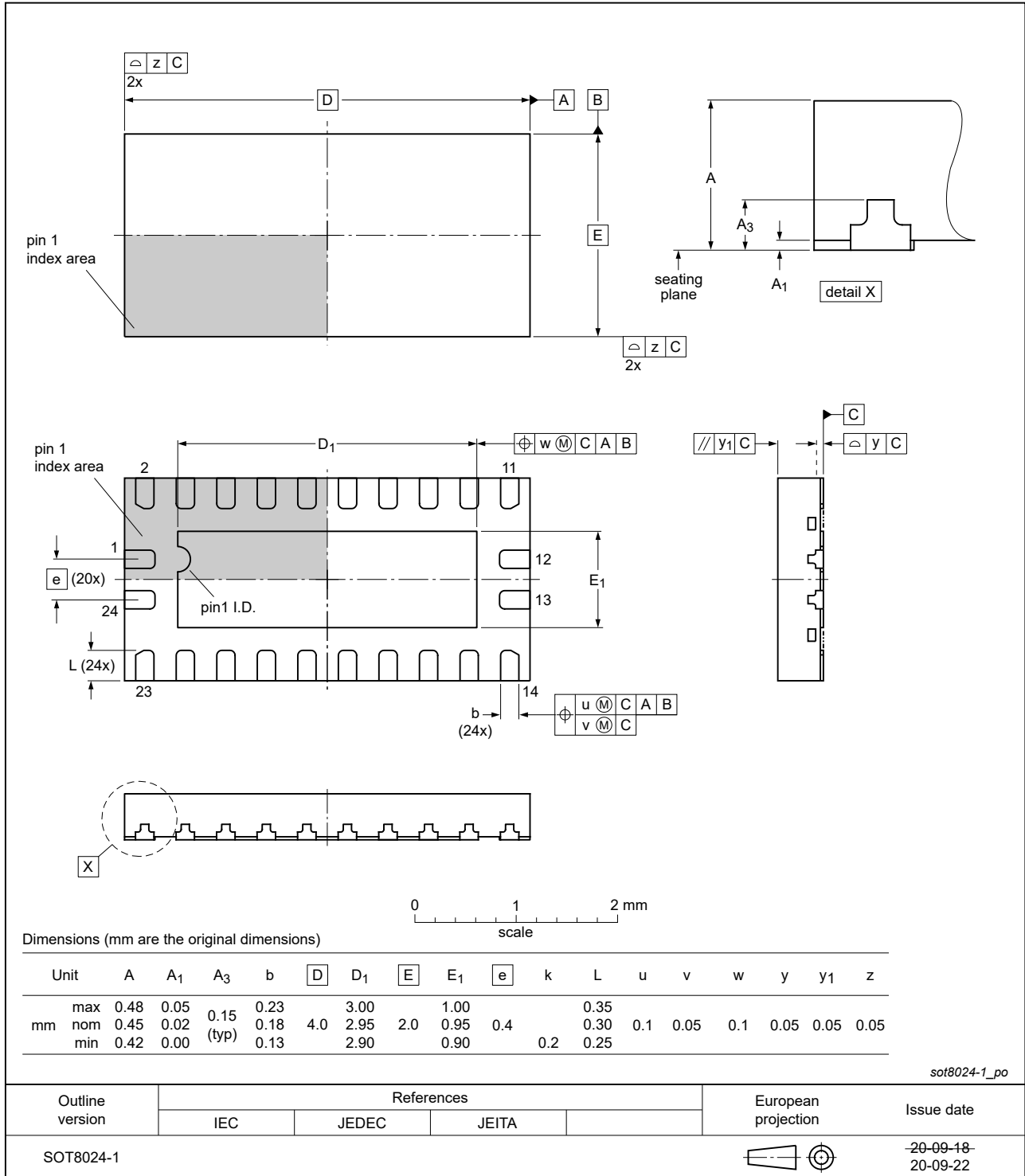

Fig. 19. Package outline SOT8024-1 (DHXQFN24)

## 14. Abbreviations

Table 18. Abbreviations

| Acronym | Description             |
|---------|-------------------------|
| CDM     | Charged Device Model    |
| DUT     | Device Under Test       |
| ESD     | ElectroStatic Discharge |
| HBM     | Human Body Model        |
| MM      | Machine Model           |

## 15. Revision history

Table 19. Revision history

| Document ID         | Release date  | Data sheet status  | Change notice | Supersedes          |
|---------------------|---|--------------------|---------------|---------------------|
| 74LVC_LVCH8T245 v.5 | 20210429  | Product data sheet | -             | 74LVC_LVCH8T245 v.4 |
| Modifications:      | <ul style="list-style-type: none"> <li>Type number 74LVC8T245BZ (SOT8024-1 / DHXQFN24) added.</li> </ul>  |                    |               |                     |
| 74LVC_LVCH8T245 v.4 | 20200922  | Product data sheet | -             | 74LVC_LVCH8T245 v.3 |
| Modifications:      | <ul style="list-style-type: none"> <li>The format of this data sheet has been redesigned to comply with the identity guidelines of Nexperia.</li> <li>Legal texts have been adapted to the new company name where appropriate.</li> <li><a href="#">Table 4</a>: Derating values for <math>P_{tot}</math> total power dissipation updated.</li> </ul> |                    |               |                     |
| 74LVC_LVCH8T245 v.3 | 20111212  | Product data sheet | -             | 74LVC_LVCH8T245 v.2 |
| Modifications:      | <ul style="list-style-type: none"> <li>Legal pages updated.</li> </ul>  |                    |               |                     |
| 74LVC_LVCH8T245 v.2 | 20110211  | Product data sheet | -             | 74LVC_LVCH8T245 v.1 |
| 74LVC_LVCH8T245 v.1 | 20100111  | Product data sheet | -             | -                   |

## 16. Legal information

### Data sheet status

| Document status [1][2]         | Product status [3] | Definition  |
|--------------------------------|--------------------|---|
| Objective [short] data sheet   | Development        | This document contains data from the objective specification for product development. |
| Preliminary [short] data sheet | Qualification      | This document contains data from the preliminary specification.                       |
| Product [short] data sheet     | Production         | This document contains the product specification.                                     |

- [1] Please consult the most recently issued document before initiating or completing a design.
- [2] The term 'short data sheet' is explained in section "Definitions".
- [3] The product status of device(s) described in this document may have changed since this document was published and may differ in case of multiple devices. The latest product status information is available on the internet at <https://www.nexperia.com>.

### Definitions

**Draft** — The document is a draft version only. The content is still under internal review and subject to formal approval, which may result in modifications or additions. Nexperia does not give any representations or warranties as to the accuracy or completeness of information included herein and shall have no liability for the consequences of use of such information.

**Short data sheet** — A short data sheet is an extract from a full data sheet with the same product type number(s) and title. A short data sheet is intended for quick reference only and should not be relied upon to contain detailed and full information. For detailed and full information see the relevant full data sheet, which is available on request via the local Nexperia sales office. In case of any inconsistency or conflict with the short data sheet, the full data sheet shall prevail.

**Product specification** — The information and data provided in a Product data sheet shall define the specification of the product as agreed between Nexperia and its customer, unless Nexperia and customer have explicitly agreed otherwise in writing. In no event however, shall an agreement be valid in which the Nexperia product is deemed to offer functions and qualities beyond those described in the Product data sheet.

### Disclaimers

**Limited warranty and liability** — Information in this document is believed to be accurate and reliable. However, Nexperia does not give any representations or warranties, expressed or implied, as to the accuracy or completeness of such information and shall have no liability for the consequences of use of such information. Nexperia takes no responsibility for the content in this document if provided by an information source outside of Nexperia.

In no event shall Nexperia be liable for any indirect, incidental, punitive, special or consequential damages (including - without limitation - lost profits, lost savings, business interruption, costs related to the removal or replacement of any products or rework charges) whether or not such damages are based on tort (including negligence), warranty, breach of contract or any other legal theory.

Notwithstanding any damages that customer might incur for any reason whatsoever, Nexperia's aggregate and cumulative liability towards customer for the products described herein shall be limited in accordance with the Terms and conditions of commercial sale of Nexperia.

**Right to make changes** — Nexperia reserves the right to make changes to information published in this document, including without limitation specifications and product descriptions, at any time and without notice. This document supersedes and replaces all information supplied prior to the publication hereof.

**Suitability for use** — Nexperia products are not designed, authorized or warranted to be suitable for use in life support, life-critical or safety-critical systems or equipment, nor in applications where failure or malfunction of an Nexperia product can reasonably be expected to result in personal

injury, death or severe property or environmental damage. Nexperia and its suppliers accept no liability for inclusion and/or use of Nexperia products in such equipment or applications and therefore such inclusion and/or use is at the customer's own risk.

**Quick reference data** — The Quick reference data is an extract of the product data given in the Limiting values and Characteristics sections of this document, and as such is not complete, exhaustive or legally binding.

**Applications** — Applications that are described herein for any of these products are for illustrative purposes only. Nexperia makes no representation or warranty that such applications will be suitable for the specified use without further testing or modification.

Customers are responsible for the design and operation of their applications and products using Nexperia products, and Nexperia accepts no liability for any assistance with applications or customer product design. It is customer's sole responsibility to determine whether the Nexperia product is suitable and fit for the customer's applications and products planned, as well as for the planned application and use of customer's third party customer(s). Customers should provide appropriate design and operating safeguards to minimize the risks associated with their applications and products.

Nexperia does not accept any liability related to any default, damage, costs or problem which is based on any weakness or default in the customer's applications or products, or the application or use by customer's third party customer(s). Customer is responsible for doing all necessary testing for the customer's applications and products using Nexperia products in order to avoid a default of the applications and the products or of the application or use by customer's third party customer(s). Nexperia does not accept any liability in this respect.

**Limiting values** — Stress above one or more limiting values (as defined in the Absolute Maximum Ratings System of IEC 60134) will cause permanent damage to the device. Limiting values are stress ratings only and (proper) operation of the device at these or any other conditions above those given in the Recommended operating conditions section (if present) or the Characteristics sections of this document is not warranted. Constant or repeated exposure to limiting values will permanently and irreversibly affect the quality and reliability of the device.

**Terms and conditions of commercial sale** — Nexperia products are sold subject to the general terms and conditions of commercial sale, as published at <http://www.nexperia.com/profile/terms>, unless otherwise agreed in a valid written individual agreement. In case an individual agreement is concluded only the terms and conditions of the respective agreement shall apply. Nexperia hereby expressly objects to applying the customer's general terms and conditions with regard to the purchase of Nexperia products by customer.

**No offer to sell or license** — Nothing in this document may be interpreted or construed as an offer to sell products that is open for acceptance or the grant, conveyance or implication of any license under any copyrights, patents or other industrial or intellectual property rights.

**Export control** — This document as well as the item(s) described herein may be subject to export control regulations. Export might require a prior authorization from competent authorities.

**Non-automotive qualified products** — Unless this data sheet expressly states that this specific Nexperia product is automotive qualified, the product is not suitable for automotive use. It is neither qualified nor tested in accordance with automotive testing or application requirements. Nexperia accepts no liability for inclusion and/or use of non-automotive qualified products in automotive equipment or applications.

In the event that customer uses the product for design-in and use in automotive applications to automotive specifications and standards, customer (a) shall use the product without Nexperia's warranty of the product for such automotive applications, use and specifications, and (b) whenever customer uses the product for automotive applications beyond Nexperia's specifications such use shall be solely at customer's own risk, and (c) customer fully indemnifies Nexperia for any liability, damages or failed product claims resulting from customer design and use of the product for automotive applications beyond Nexperia's standard warranty and Nexperia's product specifications.

**Translations** — A non-English (translated) version of a document is for reference only. The English version shall prevail in case of any discrepancy between the translated and English versions.

### Trademarks

Notice: All referenced brands, product names, service names and trademarks are the property of their respective owners.

## Contents

---

|  |           |
|--|-----------|
| <b>1. General description</b> .....                        | <b>1</b>  |
| <b>2. Features and benefits</b> .....                      | <b>1</b>  |
| <b>3. Ordering information</b> .....                       | <b>2</b>  |
| <b>4. Functional diagram</b> .....                         | <b>2</b>  |
| <b>5. Pinning information</b> .....                        | <b>3</b>  |
| 5.1. Pinning.....  | 3         |
| 5.2. Pin description.....                                  | 4         |
| <b>6. Functional description</b> .....                     | <b>4</b>  |
| <b>7. Limiting values</b> .....                            | <b>5</b>  |
| <b>8. Recommended operating conditions</b> .....           | <b>5</b>  |
| <b>9. Static characteristics</b> .....                     | <b>6</b>  |
| <b>10. Dynamic characteristics</b> .....                   | <b>9</b>  |
| 10.1. Waveforms and test circuit.....                      | 13        |
| <b>11. Typical propagation delay characteristics</b> ..... | <b>15</b> |
| <b>12. Application information</b> .....                   | <b>21</b> |
| 12.1. Unidirectional logic level-shifting application..... | 21        |
| 12.2. Bidirectional logic level-shifting application.....  | 21        |
| 12.3. Power-up considerations.....                         | 22        |
| <b>13. Package outline</b> .....                           | <b>23</b> |
| <b>14. Abbreviations</b> .....                             | <b>26</b> |
| <b>15. Revision history</b> .....                          | <b>26</b> |
| <b>16. Legal information</b> .....                         | <b>27</b> |

---

© Nexperia B.V. 2021. All rights reserved

For more information, please visit: <http://www.nexperia.com>

For sales office addresses, please send an email to: [salesaddresses@nexperia.com](mailto:salesaddresses@nexperia.com)

Date of release: 29 April 2021

---