

K 45 - 8 Ohm

Art. No. 2849



4,5 cm (1,8") Kleinlautsprecher mit Kunststoffmembran (Mylar) und Metallkorb. Geringe Baugröße, deshalb geeignet zur Signalausgabe in Geräten und Anlagen, in denen wenig Platz zur Verfügung steht.

4.5 cm (1.8") miniature speaker with plastic diaphragm (Mylar) and metal basket. Thanks to its compact dimensions, suitable for signal output in machines and other equipment where space is at a premium.

01.10.2015

K 45 - 8 Ohm

Art. No. 2849

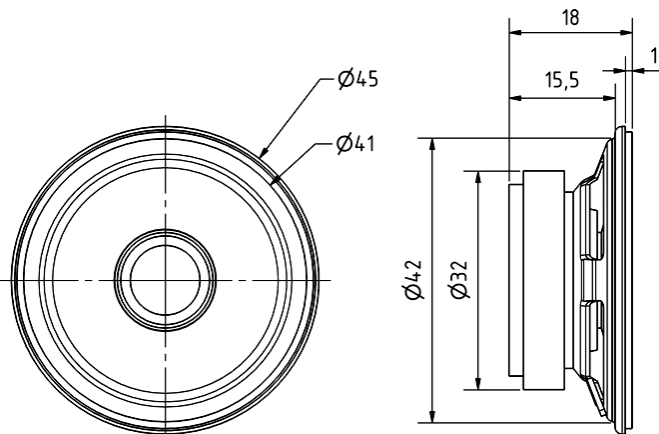

K 45
08.10.2012

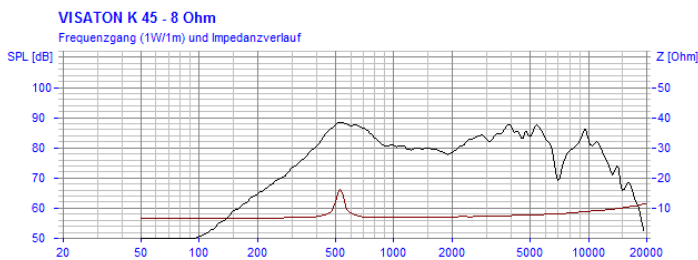

Technische Daten / Technical data

Nennbelastbarkeit Rated power	1 W
Musikbelastbarkeit Maximum power	2 W
Nennimpedanz Z Nominal impedance Z	8 Ohm
Übertragungsbereich Frequency response	300–14000 Hz
Mittlerer Schalldruckpegel Mean sound pressure level	83 dB (1 W/1 m)
Resonanzfrequenz f_s Resonance frequency f_s	520 Hz
Obere Polplattenhöhe Height of front pole-plate	1,5 mm
Schwingspulendurchmesser Voice coil diameter	14 mm
Wickelhöhe Height of winding	2,5 mm
Schallwandöffnung Cutout diameter	41,5 mm
Gewicht netto Net weight	0,046 kg
Temperaturbereich Temperature range	-25 ... 70 °C

01.10.2015