

## CHIP COILS (CHIP INDUCTORS) LQG15WH□□□□02□ Murata Standard Reference Specification [AEC-Q200]

### 1. Scope

This reference specification applies to chip coils (chip inductors) LQG15WH\_02 series for automotive electronics based on AEC-Q200.

### 2. Part Numbering

(Ex.)

LQ	G	15	W	H	1N0	S	0	2	D
Product ID	Structure	Dimension (L × W)	Application and characteristic	Category	Inductance	Tolerance	Performance	Electrode specification	Packaging D: taping *B: bulk

\*B: Bulk packing is also available.

### 3. Part Number and Rating

Operating temperature range	-55°C to +125°C
Storage temperature range	-55°C to +125°C

Customer Part number	Murata Part number	Inductance		Q (Min.)	DC resistance (Ω max.)	Self-resonant frequency (MHz min.)	Rated current (mA)	ESD Rank 1C:1kV
		Nominal value (nH)	Tolerance					
	LQG15WH0N7B02D	0.7	±0.1 nH	-	0.03	15000	1200	1C
	LQG15WH0N7C02D	0.7	±0.2 nH	-	0.03	15000	1200	1C
	LQG15WH0N7S02D	0.7	±0.3 nH	-	0.03	15000	1200	1C
	LQG15WH0N8B02D	0.8	±0.1 nH	-	0.03	15000	1200	1C
	LQG15WH0N8C02D	0.8	±0.2 nH	-	0.03	15000	1200	1C
	LQG15WH0N8S02D	0.8	±0.3 nH	-	0.03	15000	1200	1C
	LQG15WH0N9B02D	0.9	±0.1 nH	-	0.03	15000	1200	1C
	LQG15WH0N9C02D	0.9	±0.2 nH	-	0.03	15000	1200	1C
	LQG15WH0N9S02D	0.9	±0.3 nH	-	0.03	15000	1200	1C
	LQG15WH1N0B02D	1.0	±0.1 nH	-	0.03	15000	1200	1C
	LQG15WH1N0C02D	1.0	±0.2 nH	-	0.03	15000	1200	1C
	LQG15WH1N0S02D	1.0	±0.3 nH	-	0.03	15000	1200	1C
	LQG15WH1N1B02D	1.1	±0.1 nH	-	0.03	14000	1200	1C
	LQG15WH1N1C02D	1.1	±0.2 nH	-	0.03	14000	1200	1C
	LQG15WH1N1S02D	1.1	±0.3 nH	-	0.03	14000	1200	1C
	LQG15WH1N2B02D	1.2	±0.1 nH	-	0.03	13000	1200	1C
	LQG15WH1N2C02D	1.2	±0.2 nH	-	0.03	13000	1200	1C
	LQG15WH1N2S02D	1.2	±0.3 nH	-	0.03	13000	1200	1C
	LQG15WH1N3B02D	1.3	±0.1 nH	-	0.03	12000	1200	1C
	LQG15WH1N3C02D	1.3	±0.2 nH	-	0.03	12000	1200	1C
	LQG15WH1N3S02D	1.3	±0.3 nH	-	0.03	12000	1200	1C
	LQG15WH1N4B02D	1.4	±0.1 nH	23	0.04	12000	1000	1C
	LQG15WH1N4C02D	1.4	±0.2 nH	23	0.04	12000	1000	1C
	LQG15WH1N4S02D	1.4	±0.3 nH	23	0.04	12000	1000	1C
	LQG15WH1N5B02D	1.5	±0.1 nH	23	0.04	11000	1000	1C
	LQG15WH1N5C02D	1.5	±0.2 nH	23	0.04	11000	1000	1C
	LQG15WH1N5S02D	1.5	±0.3 nH	23	0.04	11000	1000	1C
	LQG15WH1N6B02D	1.6	±0.1 nH	23	0.04	10000	1000	1C
	LQG15WH1N6C02D	1.6	±0.2 nH	23	0.04	10000	1000	1C

Customer Part number	Murata Part number	Inductance		Q (Min.)	DC resistance ( $\Omega$ max.)	Self-resonant frequency (MHz min.)	Rated current (mA)	ESD Rank 1C:1kV
		Nominal value (nH)	Tolerance					
	LQG15WH1N6S02D	1.6	$\pm 0.3$ nH	23	0.04	10000	1000	1C
	LQG15WH1N7B02D	1.7	$\pm 0.1$ nH	23	0.04	10000	1000	1C
	LQG15WH1N7C02D	1.7	$\pm 0.2$ nH	23	0.04	10000	1000	1C
	LQG15WH1N7S02D	1.7	$\pm 0.3$ nH	23	0.04	10000	1000	1C
	LQG15WH1N8B02D	1.8	$\pm 0.1$ nH	23	0.04	9000	1000	1C
	LQG15WH1N8C02D	1.8	$\pm 0.2$ nH	23	0.04	9000	1000	1C
	LQG15WH1N8S02D	1.8	$\pm 0.3$ nH	23	0.04	9000	1000	1C
	LQG15WH1N9B02D	1.9	$\pm 0.1$ nH	23	0.05	8000	1000	1C
	LQG15WH1N9C02D	1.9	$\pm 0.2$ nH	23	0.05	8000	1000	1C
	LQG15WH1N9S02D	1.9	$\pm 0.3$ nH	23	0.05	8000	1000	1C
	LQG15WH2N0B02D	2.0	$\pm 0.1$ nH	23	0.05	8000	1000	1C
	LQG15WH2N0C02D	2.0	$\pm 0.2$ nH	23	0.05	8000	1000	1C
	LQG15WH2N0S02D	2.0	$\pm 0.3$ nH	23	0.05	8000	1000	1C
	LQG15WH2N1B02D	2.1	$\pm 0.1$ nH	23	0.06	8000	1000	1C
	LQG15WH2N1C02D	2.1	$\pm 0.2$ nH	23	0.06	8000	1000	1C
	LQG15WH2N1S02D	2.1	$\pm 0.3$ nH	23	0.06	8000	1000	1C
	LQG15WH2N2B02D	2.2	$\pm 0.1$ nH	23	0.06	8000	1000	1C
	LQG15WH2N2C02D	2.2	$\pm 0.2$ nH	23	0.06	8000	1000	1C
	LQG15WH2N2S02D	2.2	$\pm 0.3$ nH	23	0.06	8000	1000	1C
	LQG15WH2N3B02D	2.3	$\pm 0.1$ nH	23	0.07	7000	1000	1C
	LQG15WH2N3C02D	2.3	$\pm 0.2$ nH	23	0.07	7000	1000	1C
	LQG15WH2N3S02D	2.3	$\pm 0.3$ nH	23	0.07	7000	1000	1C
	LQG15WH2N4B02D	2.4	$\pm 0.1$ nH	23	0.06	6500	1000	1C
	LQG15WH2N4C02D	2.4	$\pm 0.2$ nH	23	0.06	6500	1000	1C
	LQG15WH2N4S02D	2.4	$\pm 0.3$ nH	23	0.06	6500	1000	1C
	LQG15WH2N5B02D	2.5	$\pm 0.1$ nH	23	0.07	6500	900	1C
	LQG15WH2N5C02D	2.5	$\pm 0.2$ nH	23	0.07	6500	900	1C
	LQG15WH2N5S02D	2.5	$\pm 0.3$ nH	23	0.07	6500	900	1C
	LQG15WH2N6B02D	2.6	$\pm 0.1$ nH	23	0.07	6500	900	1C
	LQG15WH2N6C02D	2.6	$\pm 0.2$ nH	23	0.07	6500	900	1C
	LQG15WH2N6S02D	2.6	$\pm 0.3$ nH	23	0.07	6500	900	1C
	LQG15WH2N7B02D	2.7	$\pm 0.1$ nH	23	0.07	6500	900	1C
	LQG15WH2N7C02D	2.7	$\pm 0.2$ nH	23	0.07	6500	900	1C
	LQG15WH2N7S02D	2.7	$\pm 0.3$ nH	23	0.07	6500	900	1C
	LQG15WH2N8B02D	2.8	$\pm 0.1$ nH	23	0.08	6500	900	1C
	LQG15WH2N8C02D	2.8	$\pm 0.2$ nH	23	0.08	6500	900	1C
	LQG15WH2N8S02D	2.8	$\pm 0.3$ nH	23	0.08	6500	900	1C
	LQG15WH2N9B02D	2.9	$\pm 0.1$ nH	23	0.08	6500	900	1C
	LQG15WH2N9C02D	2.9	$\pm 0.2$ nH	23	0.08	6500	900	1C
	LQG15WH2N9S02D	2.9	$\pm 0.3$ nH	23	0.08	6500	900	1C
	LQG15WH3N0B02D	3.0	$\pm 0.1$ nH	23	0.08	6000	900	1C
	LQG15WH3N0C02D	3.0	$\pm 0.2$ nH	23	0.08	6000	900	1C
	LQG15WH3N0S02D	3.0	$\pm 0.3$ nH	23	0.08	6000	900	1C
	LQG15WH3N1B02D	3.1	$\pm 0.1$ nH	23	0.09	6000	900	1C
	LQG15WH3N1C02D	3.1	$\pm 0.2$ nH	23	0.09	6000	900	1C

Customer Part number	Murata Part number	Inductance		Q (Min.)	DC resistance ( $\Omega$ max.)	Self-resonant frequency (MHz min.)	Rated current (mA)	ESD Rank 1C:1kV
		Nominal value (nH)	Tolerance					
	LQG15WH3N1S02D	3.1	$\pm 0.3$ nH	23	0.09	6000	900	1C
	LQG15WH3N2B02D	3.2	$\pm 0.1$ nH	23	0.09	6000	900	1C
	LQG15WH3N2C02D	3.2	$\pm 0.2$ nH	23	0.09	6000	900	1C
	LQG15WH3N2S02D	3.2	$\pm 0.3$ nH	23	0.09	6000	900	1C
	LQG15WH3N3B02D	3.3	$\pm 0.1$ nH	23	0.08	6000	900	1C
	LQG15WH3N3C02D	3.3	$\pm 0.2$ nH	23	0.08	6000	900	1C
	LQG15WH3N3S02D	3.3	$\pm 0.3$ nH	23	0.08	6000	900	1C
	LQG15WH3N4B02D	3.4	$\pm 0.1$ nH	23	0.09	6000	900	1C
	LQG15WH3N4C02D	3.4	$\pm 0.2$ nH	23	0.09	6000	900	1C
	LQG15WH3N4S02D	3.4	$\pm 0.3$ nH	23	0.09	6000	900	1C
	LQG15WH3N5B02D	3.5	$\pm 0.1$ nH	23	0.09	5800	900	1C
	LQG15WH3N5C02D	3.5	$\pm 0.2$ nH	23	0.09	5800	900	1C
	LQG15WH3N5S02D	3.5	$\pm 0.3$ nH	23	0.09	5800	900	1C
	LQG15WH3N6B02D	3.6	$\pm 0.1$ nH	23	0.09	5500	900	1C
	LQG15WH3N6C02D	3.6	$\pm 0.2$ nH	23	0.09	5500	900	1C
	LQG15WH3N6S02D	3.6	$\pm 0.3$ nH	23	0.09	5500	900	1C
	LQG15WH3N7B02D	3.7	$\pm 0.1$ nH	23	0.1	5500	900	1C
	LQG15WH3N7C02D	3.7	$\pm 0.2$ nH	23	0.1	5500	900	1C
	LQG15WH3N7S02D	3.7	$\pm 0.3$ nH	23	0.1	5500	900	1C
	LQG15WH3N8B02D	3.8	$\pm 0.1$ nH	23	0.1	5000	900	1C
	LQG15WH3N8C02D	3.8	$\pm 0.2$ nH	23	0.1	5000	900	1C
	LQG15WH3N8S02D	3.8	$\pm 0.3$ nH	23	0.1	5000	900	1C
	LQG15WH3N9B02D	3.9	$\pm 0.1$ nH	23	0.09	5000	900	1C
	LQG15WH3N9C02D	3.9	$\pm 0.2$ nH	23	0.09	5000	900	1C
	LQG15WH3N9S02D	3.9	$\pm 0.3$ nH	23	0.09	5000	900	1C
	LQG15WH4N1B02D	4.1	$\pm 0.1$ nH	23	0.1	5000	800	1C
	LQG15WH4N1C02D	4.1	$\pm 0.2$ nH	23	0.1	5000	800	1C
	LQG15WH4N1S02D	4.1	$\pm 0.3$ nH	23	0.1	5000	800	1C
	LQG15WH4N3B02D	4.3	$\pm 0.1$ nH	23	0.1	5000	800	1C
	LQG15WH4N3C02D	4.3	$\pm 0.2$ nH	23	0.1	5000	800	1C
	LQG15WH4N3S02D	4.3	$\pm 0.3$ nH	23	0.1	5000	800	1C
	LQG15WH4N7B02D	4.7	$\pm 0.1$ nH	23	0.11	5000	800	1C
	LQG15WH4N7C02D	4.7	$\pm 0.2$ nH	23	0.11	5000	800	1C
	LQG15WH4N7S02D	4.7	$\pm 0.3$ nH	23	0.11	5000	800	1C
	LQG15WH5N1B02D	5.1	$\pm 0.1$ nH	23	0.12	4500	800	1C
	LQG15WH5N1C02D	5.1	$\pm 0.2$ nH	23	0.12	4500	800	1C
	LQG15WH5N1S02D	5.1	$\pm 0.3$ nH	23	0.12	4500	800	1C
	LQG15WH5N6B02D	5.6	$\pm 0.1$ nH	23	0.13	4500	800	1C
	LQG15WH5N6C02D	5.6	$\pm 0.2$ nH	23	0.13	4500	800	1C
	LQG15WH5N6S02D	5.6	$\pm 0.3$ nH	23	0.13	4500	800	1C
	LQG15WH5N8B02D	5.8	$\pm 0.1$ nH	23	0.13	4000	700	1C
	LQG15WH5N8C02D	5.8	$\pm 0.2$ nH	23	0.13	4000	700	1C
	LQG15WH5N8S02D	5.8	$\pm 0.3$ nH	23	0.13	4000	700	1C
	LQG15WH6N2B02D	6.2	$\pm 0.1$ nH	23	0.13	4000	700	1C
	LQG15WH6N2C02D	6.2	$\pm 0.2$ nH	23	0.13	4000	700	1C

Customer Part number	Murata Part number	Inductance		Q (Min.)	DC resistance ( $\Omega$ max.)	Self-resonant frequency (MHz min.)	Rated current (mA)	ESD Rank 1C:1kV
		Nominal value (nH)	Tolerance					
	LQG15WH6N2S02D	6.2	$\pm 0.3$ nH	23	0.13	4000	700	1C
	LQG15WH6N8G02D	6.8	$\pm 2\%$	23	0.14	4000	700	1C
	LQG15WH6N8H02D	6.8	$\pm 3\%$	23	0.14	4000	700	1C
	LQG15WH6N8J02D	6.8	$\pm 5\%$	23	0.14	4000	700	1C
	LQG15WH7N3G02D	7.3	$\pm 2\%$	23	0.17	4000	600	1C
	LQG15WH7N3H02D	7.3	$\pm 3\%$	23	0.17	4000	600	1C
	LQG15WH7N3J02D	7.3	$\pm 5\%$	23	0.17	4000	600	1C
	LQG15WH7N5G02D	7.5	$\pm 2\%$	23	0.16	4000	600	1C
	LQG15WH7N5H02D	7.5	$\pm 3\%$	23	0.16	4000	600	1C
	LQG15WH7N5J02D	7.5	$\pm 5\%$	23	0.16	4000	600	1C
	LQG15WH8N2G02D	8.2	$\pm 2\%$	23	0.16	3600	550	1C
	LQG15WH8N2H02D	8.2	$\pm 3\%$	23	0.16	3600	550	1C
	LQG15WH8N2J02D	8.2	$\pm 5\%$	23	0.16	3600	550	1C
	LQG15WH8N7G02D	8.7	$\pm 2\%$	23	0.17	3500	550	1C
	LQG15WH8N7H02D	8.7	$\pm 3\%$	23	0.17	3500	550	1C
	LQG15WH8N7J02D	8.7	$\pm 5\%$	23	0.17	3500	550	1C
	LQG15WH9N1G02D	9.1	$\pm 2\%$	23	0.17	3400	550	1C
	LQG15WH9N1H02D	9.1	$\pm 3\%$	23	0.17	3400	550	1C
	LQG15WH9N1J02D	9.1	$\pm 5\%$	23	0.17	3400	550	1C
	LQG15WH9N5G02D	9.5	$\pm 2\%$	23	0.21	3300	500	1C
	LQG15WH9N5H02D	9.5	$\pm 3\%$	23	0.21	3300	500	1C
	LQG15WH9N5J02D	9.5	$\pm 5\%$	23	0.21	3300	500	1C
	LQG15WH10NG02D	10	$\pm 2\%$	23	0.19	3300	500	1C
	LQG15WH10NH02D	10	$\pm 3\%$	23	0.19	3300	500	1C
	LQG15WH10NJ02D	10	$\pm 5\%$	23	0.19	3300	500	1C
	LQG15WH11NG02D	11	$\pm 2\%$	23	0.22	3000	450	1C
	LQG15WH11NH02D	11	$\pm 3\%$	23	0.22	3000	450	1C
	LQG15WH11NJ02D	11	$\pm 5\%$	23	0.22	3000	450	1C
	LQG15WH12NG02D	12	$\pm 2\%$	23	0.24	2800	450	1C
	LQG15WH12NH02D	12	$\pm 3\%$	23	0.24	2800	450	1C
	LQG15WH12NJ02D	12	$\pm 5\%$	23	0.24	2800	450	1C
	LQG15WH13NG02D	13	$\pm 2\%$	23	0.26	2800	400	1C
	LQG15WH13NH02D	13	$\pm 3\%$	23	0.26	2800	400	1C
	LQG15WH13NJ02D	13	$\pm 5\%$	23	0.26	2800	400	1C
	LQG15WH15NG02D	15	$\pm 2\%$	23	0.28	2300	400	1C
	LQG15WH15NH02D	15	$\pm 3\%$	23	0.28	2300	400	1C
	LQG15WH15NJ02D	15	$\pm 5\%$	23	0.28	2300	400	1C
	LQG15WH16NG02D	16	$\pm 2\%$	20	0.8	2300	260	1C
	LQG15WH16NH02D	16	$\pm 3\%$	20	0.8	2300	260	1C
	LQG15WH16NJ02D	16	$\pm 5\%$	20	0.8	2300	260	1C
	LQG15WH18NG02D	18	$\pm 2\%$	22	0.8	2300	260	1C
	LQG15WH18NH02D	18	$\pm 3\%$	22	0.8	2300	260	1C
	LQG15WH18NJ02D	18	$\pm 5\%$	22	0.8	2300	260	1C
	LQG15WH19NG02D	19	$\pm 2\%$	20	0.8	2300	260	1C
	LQG15WH19NH02D	19	$\pm 3\%$	20	0.8	2300	260	1C

Customer Part number	Murata Part number	Inductance		Q (Min.)	DC resistance ( $\Omega$ max.)	Self-resonant frequency (MHz min.)	Rated current (mA)	ESD Rank 1C:1kV
		Nominal value (nH)	Tolerance					
	LQG15WH19NJ02D	19	$\pm 5\%$	20	0.8	2300	260	1C
	LQG15WH20NG02D	20	$\pm 2\%$	20	1.1	2100	260	1C
	LQG15WH20NH02D	20	$\pm 3\%$	20	1.1	2100	260	1C
	LQG15WH20NJ02D	20	$\pm 5\%$	20	1.1	2100	260	1C
	LQG15WH22NG02D	22	$\pm 2\%$	20	1.1	2100	230	1C
	LQG15WH22NH02D	22	$\pm 3\%$	20	1.1	2100	230	1C
	LQG15WH22NJ02D	22	$\pm 5\%$	20	1.1	2100	230	1C
	LQG15WH23NG02D	23	$\pm 2\%$	22	1.1	2000	230	1C
	LQG15WH23NH02D	23	$\pm 3\%$	22	1.1	2000	230	1C
	LQG15WH23NJ02D	23	$\pm 5\%$	22	1.1	2000	230	1C
	LQG15WH24NG02D	24	$\pm 2\%$	20	1.2	2000	230	1C
	LQG15WH24NH02D	24	$\pm 3\%$	20	1.2	2000	230	1C
	LQG15WH24NJ02D	24	$\pm 5\%$	20	1.2	2000	230	1C
	LQG15WH27NG02D	27	$\pm 2\%$	20	1.3	1700	230	1C
	LQG15WH27NH02D	27	$\pm 3\%$	20	1.3	1700	230	1C
	LQG15WH27NJ02D	27	$\pm 5\%$	20	1.3	1700	230	1C
	LQG15WH30NG02D	30	$\pm 2\%$	20	1.3	1700	220	1C
	LQG15WH30NH02D	30	$\pm 3\%$	20	1.3	1700	220	1C
	LQG15WH30NJ02D	30	$\pm 5\%$	20	1.3	1700	220	1C
	LQG15WH33NG02D	33	$\pm 2\%$	20	1.5	1600	220	1C
	LQG15WH33NH02D	33	$\pm 3\%$	20	1.5	1600	220	1C
	LQG15WH33NJ02D	33	$\pm 5\%$	20	1.5	1600	220	1C
	LQG15WH36NG02D	36	$\pm 2\%$	20	1.5	1600	190	1C
	LQG15WH36NH02D	36	$\pm 3\%$	20	1.5	1600	190	1C
	LQG15WH36NJ02D	36	$\pm 5\%$	20	1.5	1600	190	1C
	LQG15WH39NG02D	39	$\pm 2\%$	20	1.5	1400	190	1C
	LQG15WH39NH02D	39	$\pm 3\%$	20	1.5	1400	190	1C
	LQG15WH39NJ02D	39	$\pm 5\%$	20	1.5	1400	190	1C
	LQG15WH40NG02D	40	$\pm 2\%$	20	1.5	1400	190	1C
	LQG15WH40NH02D	40	$\pm 3\%$	20	1.5	1400	190	1C
	LQG15WH40NJ02D	40	$\pm 5\%$	20	1.5	1400	190	1C
	LQG15WH43NG02D	43	$\pm 2\%$	22	1.6	1400	190	1C
	LQG15WH43NH02D	43	$\pm 3\%$	22	1.6	1400	190	1C
	LQG15WH43NJ02D	43	$\pm 5\%$	22	1.6	1400	190	1C
	LQG15WH47NG02D	47	$\pm 2\%$	22	1.6	1300	190	1C
	LQG15WH47NH02D	47	$\pm 3\%$	22	1.6	1300	190	1C
	LQG15WH47NJ02D	47	$\pm 5\%$	22	1.6	1300	190	1C
	LQG15WH51NG02D	51	$\pm 2\%$	22	1.8	1300	190	1C
	LQG15WH51NH02D	51	$\pm 3\%$	22	1.8	1300	190	1C
	LQG15WH51NJ02D	51	$\pm 5\%$	22	1.8	1300	190	1C
	LQG15WH56NG02D	56	$\pm 2\%$	22	1.8	1200	180	1C
	LQG15WH56NH02D	56	$\pm 3\%$	22	1.8	1200	180	1C
	LQG15WH56NJ02D	56	$\pm 5\%$	22	1.8	1200	180	1C
	LQG15WH62NG02D	62	$\pm 2\%$	22	1.9	1100	180	1C
	LQG15WH62NH02D	62	$\pm 3\%$	22	1.9	1100	180	1C

Customer Part number	Murata Part number	Inductance		Q (Min.)	DC resistance ( $\Omega$ max.)	Self-resonant frequency (MHz min.)	Rated current (mA)	ESD Rank 1C:1kV
		Nominal value (nH)	Tolerance					
	LQG15WH62NJ02D	62	$\pm 5\%$	22	1.9	1100	180	1C
	LQG15WH68NG02D	68	$\pm 2\%$	22	2	1100	160	1C
	LQG15WH68NH02D	68	$\pm 3\%$	22	2	1100	160	1C
	LQG15WH68NJ02D	68	$\pm 5\%$	22	2	1100	160	1C
	LQG15WH72NG02D	72	$\pm 2\%$	22	2.2	1100	160	1C
	LQG15WH72NH02D	72	$\pm 3\%$	22	2.2	1100	160	1C
	LQG15WH72NJ02D	72	$\pm 5\%$	22	2.2	1100	160	1C
	LQG15WH75NG02D	75	$\pm 2\%$	22	2.2	1100	160	1C
	LQG15WH75NH02D	75	$\pm 3\%$	22	2.2	1100	160	1C
	LQG15WH75NJ02D	75	$\pm 5\%$	22	2.2	1100	160	1C
	LQG15WH82NG02D	82	$\pm 2\%$	22	2.3	900	160	1C
	LQG15WH82NH02D	82	$\pm 3\%$	22	2.3	900	160	1C
	LQG15WH82NJ02D	82	$\pm 5\%$	22	2.3	900	160	1C
	LQG15WH91NG02D	91	$\pm 2\%$	23	2.3	900	160	1C
	LQG15WH91NH02D	91	$\pm 3\%$	23	2.3	900	160	1C
	LQG15WH91NJ02D	91	$\pm 5\%$	23	2.3	900	160	1C
	LQG15WHR10G02D	100	$\pm 2\%$	23	2.5	900	150	1C
	LQG15WHR10H02D	100	$\pm 3\%$	23	2.5	900	150	1C
	LQG15WHR10J02D	100	$\pm 5\%$	23	2.5	900	150	1C
	LQG15WHR11G02D	110	$\pm 2\%$	22	2.7	800	150	1C
	LQG15WHR11H02D	110	$\pm 3\%$	22	2.7	800	150	1C
	LQG15WHR11J02D	110	$\pm 5\%$	22	2.7	800	150	1C
	LQG15WHR12G02D	120	$\pm 2\%$	22	2.7	800	140	1C
	LQG15WHR12H02D	120	$\pm 3\%$	22	2.7	800	140	1C
	LQG15WHR12J02D	120	$\pm 5\%$	22	2.7	800	140	1C
	LQG15WHR13G02D	130	$\pm 2\%$	22	2.9	800	110	1C
	LQG15WHR13H02D	130	$\pm 3\%$	22	2.9	800	110	1C
	LQG15WHR13J02D	130	$\pm 5\%$	22	2.9	800	110	1C
	LQG15WHR15G02D	150	$\pm 2\%$	22	3	800	110	1C
	LQG15WHR15H02D	150	$\pm 3\%$	22	3	800	110	1C
	LQG15WHR15J02D	150	$\pm 5\%$	22	3	800	110	1C

**4. Testing Conditions**

Unless otherwise specified	Temperature: ordinary temperature (15°C to 35°C) Humidity: ordinary humidity [25% to 85% (RH)]
In case of doubt	Temperature: 20°C $\pm$ 2°C Humidity: 60% to 70% (RH) Atmospheric pressure: 86 kPa to 106 kPa

**5. Appearance and Dimensions**

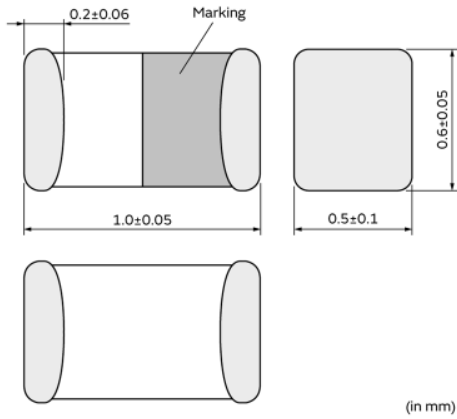

Unit mass (typical value): 0.001 g

**6. Marking**

Direction identification marking: black

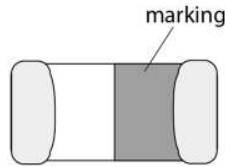

**7. Electrical Performance**

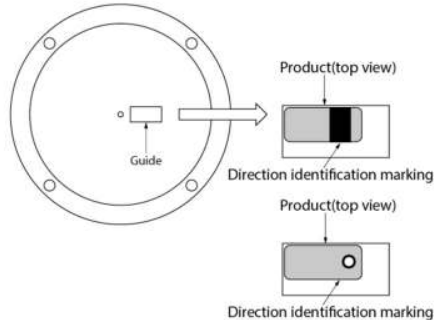
No.	Item	Specification	Test method
7.1	Inductance	Meet chapter 3 ratings.	Measuring equipment: Keysight E4991A or the equivalent Measuring frequency: Inductance: 100 MHz Q: 250 MHz Measuring conditions: Measurement signal level: Approx. 0 dBm Measurement terminal distance: 0.5 mm Electrical length: 10 mm Weight: Approx. 1 N to 5 N Measuring fixture: Keysight 16197A Position the chip coil under test as shown in the measuring example below and connect it to the electrode by applying weight. Measurement example: 
7.2	Q	Meet chapter 3 ratings.	

Measuring method: see "Electrical performance: Measuring method for inductance/Q" in the Appendix.

No.	Item	Specification	Test method
7.3	DC resistance	Meet chapter 3 ratings.	Measuring equipment: digital multimeter
7.4	Self-resonant frequency	Meet chapter 3 ratings.	Measuring equipment: Keysight N5230A or the equivalent
7.5	Rated current	Product temperature rise: 25°C max.	Apply the rated current specified in chapter 3.

## 8. AEC-Q200 Requirement

### 8.1 Performance [based on table 5 for magnetics (inductors/transformer) AEC-Q200 Rev. D issued June 1, 2010]

AEC-Q200			Murata specification/deviation				
No.	Stress	Test method					
3	High temperature exposure	1000 h at 125°C Set for 24 h at room condition, then measured.	Meet table A after testing. Table A <table border="1"> <tr> <td>Appearance</td> <td>No damage</td> </tr> <tr> <td>Inductance change rate (at 100 MHz)</td> <td>Within ±10%</td> </tr> </table>	Appearance	No damage	Inductance change rate (at 100 MHz)	Within ±10%
Appearance	No damage						
Inductance change rate (at 100 MHz)	Within ±10%						
4	Temperature cycling	1000 cycles -40°C to +125°C Set for 24 h at room condition, then measured.	Meet table A after testing.				
7	Biased humidity	1000 h at 85°C, 85% (RH). Unpowered. Set for 24 h at room condition, then measured.	Meet table A after testing.				
8	Operational life	Apply 125°C 1000 h Set for 24 h at room condition, then measured.	Meet table A after testing.				
9	External visual	Visual inspection	No abnormalities				
10	Physical dimension	Meet chapter 5, "Appearance and Dimensions".	No defects				
12	Resistance to solvents	Per MIL-STD-202 Method 215	Not applicable				
13	Mechanical shock	Per MIL-STD-202 Method 213 Condition C: 100 g's (0.98 N), 6 ms, half sine, 12.3 ft/s	Meet table A after testing.				
14	Vibration	5 g's (0.049 N) for 20 min, 12 cycles each of 3 orientations Test from 10 Hz to 2000 Hz	Meet table A after testing.				
15	Resistance to soldering heat	No-heating Solder temperature 260°C±5°C Immersion time 10 s	Pre-heating: 150°C±10°C, 60 s to 90 s Meet table A after testing.				
17	ESD	Per AEC-Q200-002	ESD rank: Refer to chapter 3 ratings. Meet table A after testing.				
18	Solderability	Per J-STD-002	Method b: not applicable 90% of the terminations is to be soldered.				
19	Electrical characterization	Measured: inductance	No defects				
20	Flammability	Per UL-94	Not applicable				
21	Board flex	Epoxy-PCB (1.6 mm) Deflection 2 mm (min.) Holding time 60 s	Meet table B after testing. Table B <table border="1"> <tr> <td>Appearance</td> <td>No damage</td> </tr> <tr> <td>DC resistance change rate</td> <td>Within ±10%</td> </tr> </table>	Appearance	No damage	DC resistance change rate	Within ±10%
Appearance	No damage						
DC resistance change rate	Within ±10%						
22	Terminal strength	Per AEC-Q200-006 A force of 17.7 N for 60 s	Murata deviation request: 5 N No defects				



## 9. Specification of Packaging

### 9.1 Appearance and dimensions of tape (8 mm width/paper tape)

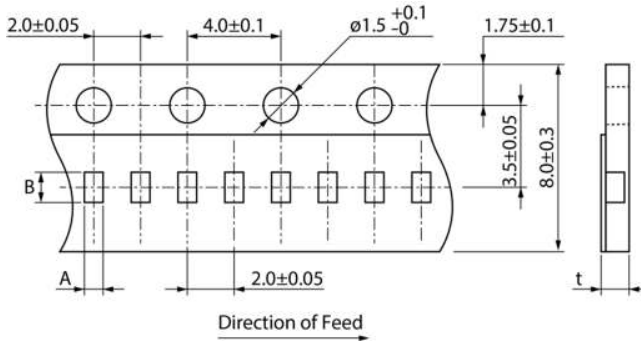

A	(0.69)
B	(1.18)
t	0.85 max.

(in mm)

■ Top view

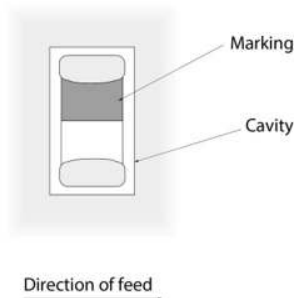

### 9.2 Taping specifications

Packing quantity (Standard quantity)	10000 pcs/reel
Packing method	The products are placed in cavities of a carrier tape and sealed by a cover tape (top tape and bottom tape when the cavities of the carrier tape are punched type).
Feed hole position	The feed holes on the carrier tape are on the right side when the cover tape (top tape when the cavities of the carrier tape are punched type) is pulled toward the user.
Joint	The carrier tape and cover tape (top tape when the cavities of the carrier tape are punched type) are seamless.
Number of missing products	Number of missing products within 0.025% of the number per reel or 1 pc., whichever is greater, and are not continuous. The specified quantity per reel is kept.

### 9.3 Break down force of tape

Cover tape (or top tape)	5 N min.
Bottom tape (only when the cavities of the carrier tape are punched type)	5 N min.

### 9.4 Peeling off force of tape

Speed of peeling off	300 mm/min
Peeling off force	0.1 N to 0.6 N (The lower limit is for typical value.)

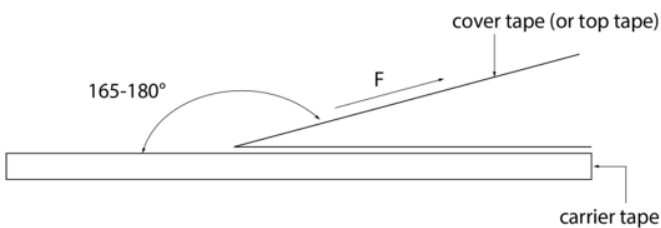

### 9.5 Dimensions of leader section, trailer section and reel

A vacant section is provided in the leader (start) section and trailer (end) section of the tape for the product. The leader section is further provided with an area consisting only of the cover tape (or top tape). (See the diagram below.)

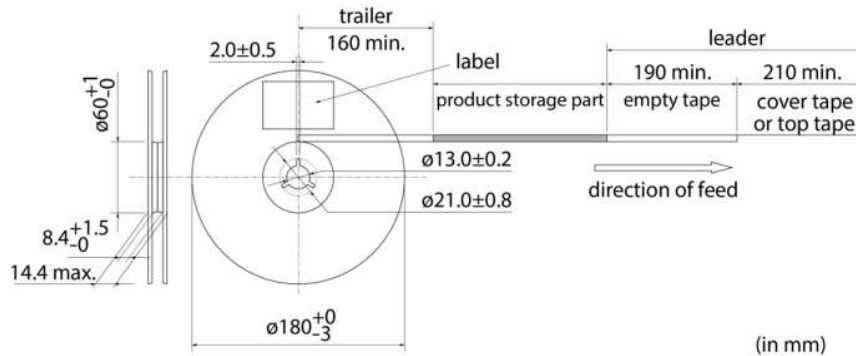

### 9.6 Marking for reel

Customer part number, Murata part number, inspection number (\*1), RoHS marking (\*2), quantity, etc.

<p>*1 Expression of inspection No.:</p> <div style="display: flex; justify-content: space-around; align-items: center;"> <div style="text-align: center;">□□ (1)</div> <div style="text-align: center;">○○○○ (2)</div> <div style="text-align: center;">◇◇◇◇ (3)</div> </div>	<p>(1) Factory code (2) Date First digit: year/last digit of year Second digit: month/Jan. to Sep.→1 to 9, Oct. to Dec.→O, N, D Third, Fourth digit: day (3) Serial No.</p>
<p>*2 Expression of RoHS marking:</p> <div style="display: flex; justify-content: space-around; align-items: center;"> <div style="text-align: center;">ROHS- Y (1)</div> <div style="text-align: center;">(Δ) (2)</div> </div>	<p>(1) RoHS regulation conformity (2) Murata classification number</p>

### 9.7 Marking on outer box (corrugated box)

Customer name, purchasing order number, customer part number, Murata part number, RoHS marking (\*2), quantity, etc.

### 9.8 Specification of outer box

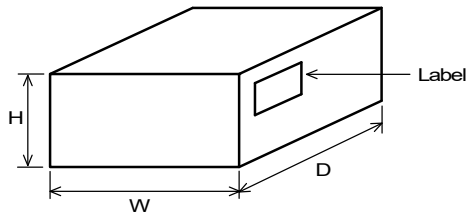

Dimensions of outer box (mm)			Standard reel quantity in outer box (reel)
W	D	H	
186	186	93	5
* Above outer box size is typical. It depends on a quantity of an order.			

## 10. ⚠Caution

### 10.1 Restricted applications

Please contact us before using our products for the applications listed below which require especially high reliability for the prevention of defects which might directly cause damage to the third party's life, body or property.

- |                               |   |                              |   |
|-------------------------------|---|------------------------------|---|
| (1) Aircraft equipment        | (2) Aerospace equipment   | (3) Undersea equipment       | (4) Power plant control equipment       |
| (5) Medical equipment         | (6) Transportation equipment (trains, ships, etc.)  | (7) Traffic signal equipment | (8) Disaster/crime prevention equipment |
| (9) Data-processing equipment | (10) Applications of similar complexity and/or reliability requirements to the applications listed in the above |                              |   |

**10.2 Precautions on rating**

Avoid using in exceeded the rated temperature range, rated voltage, or rated current.  
Usage when the ratings are exceeded could lead to wire breakage, burning, or other serious fault.

**10.3 Inrush current**

If an inrush current (or pulse current or rush current) that significantly exceeds the rated current is applied to the product, overheating could occur, resulting in wire breakage, burning, or other serious fault.

**10.4 Fail-safe**

Be sure to provide an appropriate fail-safe function on your product to prevent a second damage that may be caused by the abnormal function or the failure of our product.

**11. Precautions for Use**

This product is for use only with reflow soldering. It is designed to be mounted by soldering. If you want to use other mounting method, for example, using a conductive adhesive, please consult us beforehand.  
Also, if repeatedly subjected to temperature cycles or other thermal stress, due to the difference in the coefficient of thermal expansion with the mounting substrate, the solder (solder fillet part) in the mounting part may crack.  
The occurrence of cracks due to thermal stress is affected by the size of the land where mounted, the solder volume, and the heat dissipation of the mounting substrate. Carefully design it when a large change in ambient temperature is assumed.

**11.1. Land dimensions**

The following diagram shows the recommended land dimensions for reflow soldering:

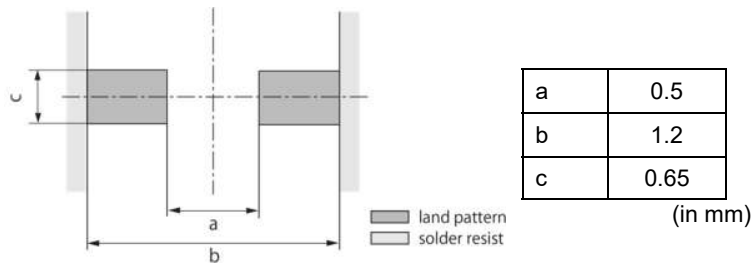
**11.2 Flux and solder used**

Flux	<ul style="list-style-type: none"> <li>• Use a rosin-based flux.</li> <li>• Do not use a highly acidic flux with a halide content exceeding 0.2(wt)% (chlorine conversion value).</li> <li>• Do not use a water-soluble flux.</li> </ul>
Solder	<ul style="list-style-type: none"> <li>• Use Sn-3.0Ag-0.5Cu solder.</li> <li>• Standard thickness of solder paste: 100 μm to 150 μm</li> </ul>

If you want to use a flux other than the above, please consult our technical department.

### 11.3 Soldering conditions (reflow)

- Pre-heating should be in such a way that the temperature difference between solder and product surface is limited to 150°C max.  
Cooling into solvent after soldering also should be in such a way that the temperature difference is limited to 100°C max. Insufficient pre-heating may cause cracks on the product, resulting in the deterioration of product quality.
- Standard soldering profile and the limit soldering profile is as follows.  
The excessive limit soldering conditions may cause leaching of the electrode and/or resulting in the deterioration of product quality.

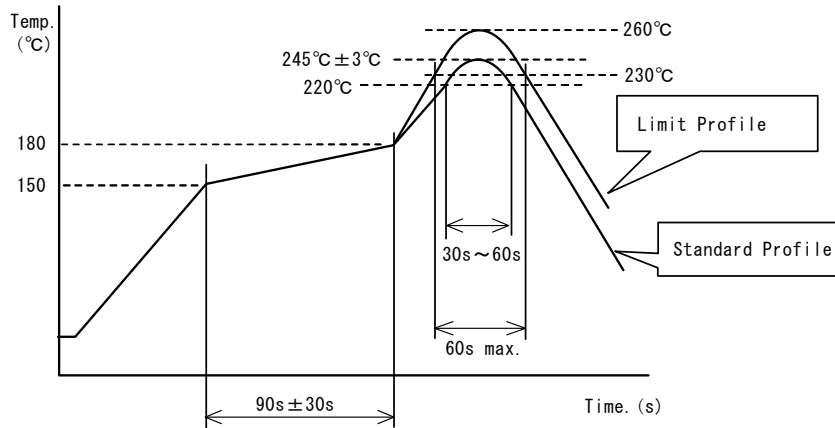

	Standard profile	Limit profile
Pre-heating	150°C to 180°C/90 s±30 s	150°C to 180°C/90 s±30 s
Heating	Above 220°C/30 s to 60 s	Above 230°C/60 s max.
Peak temperature	245°C±3°C	260°C/10 s
Number of reflow cycles	2 times	2 times

### 11.4 Reworking with soldering iron

The following requirements must be met to rework a soldered product using a soldering iron.

Item	Requirement
Pre-heating	150°C/approx. 1 min
Tip temperature of soldering iron	350°C max.
Power consumption of soldering iron	80 W max.
Tip diameter of soldering iron	ø3 mm max.
Soldering time	3 s (+1 s, -0 s)
Number of reworking operations	2 times max.
* Avoid a direct contact of the tip of the soldering iron with the product. Such a direction contact may cause cracks in the ceramic body due to thermal shock.	

### 11.5 Solder volume

Solder shall be used not to be exceeded the upper limits as shown below.

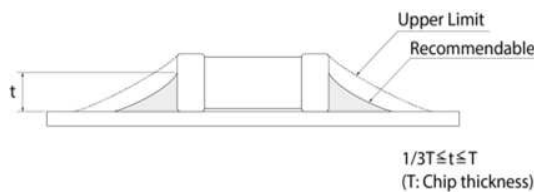

An increased solder volume increases mechanical stress on the product. Exceeding solder volume may cause the failure of mechanical or electrical performance.

## 11.6 Product's location

The following shall be considered when designing and laying out PCBs.

(1) PCB shall be designed so that products are not subject to mechanical stress due to warping the board.

[Products direction]

Products shall be located in the sideways direction (length:  $a < b$ ) to the mechanical stress.

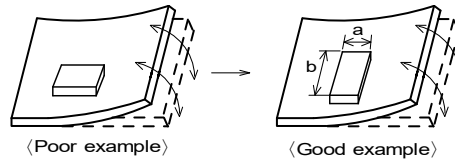

(2) Components location on PCB separation

It is effective to implement the following measures, to reduce stress in separating the board.

It is best to implement all of the following three measures; however, implement as many measures as possible to reduce stress.

Contents of measures	Stress level
(1) Turn the mounting direction of the component parallel to the board separation surface.	$A > D^*1$
(2) Add slits in the board separation part.	$A > B$
(3) Keep the mounting position of the component away from the board separation surface.	$A > C$
*1 $A > D$ is valid when stress is added vertically to the perforation as with hand separation. If a cutting disc is used, stress will be diagonal to the PCB, therefore $A > D$ is invalid.	

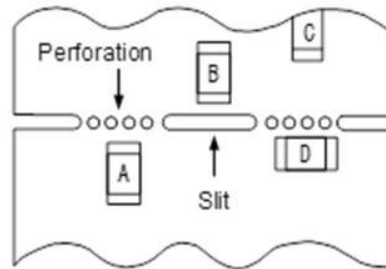

(3) Mounting components near screw holes

When a component is mounted near a screw hole, it may be affected by the board deflection that occurs during the tightening of the screw.

Mount the component in a position as far away from the screw holes as possible.

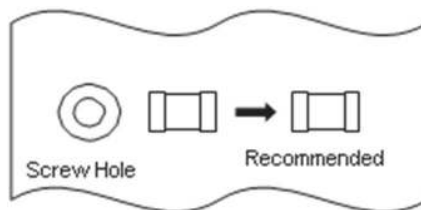

## 11.7 Handling of substrate

After mounting products on a substrate, do not apply any stress to the product caused by bending or twisting to the substrate when cropping the substrate, inserting and removing a connector from the substrate or tightening screw to the substrate. Excessive mechanical stress may cause cracking in the product.

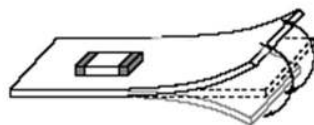

Bending

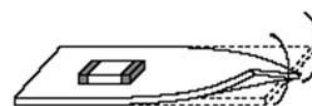

Twisting

**11.8 Cleaning**

The product shall be cleaned under the following conditions.

- (1) The cleaning temperature shall be 60°C max. If isopropyl alcohol (IPA) is used, the cleaning temperature shall be 40°C max.
- (2) Perform ultrasonic cleaning under the following conditions. Exercise caution to prevent resonance phenomenon in mounted products and the PCB.

Item	Requirement
Power	20 W/L max.
Time	5 min max.
Frequency	28 kHz to 40 kHz

- (3) Cleaner

Alcohol-based cleaner: IPA

Aqueous agent: PINE ALPHA ST-100S

- (4) There shall be no residual flux or residual cleaner. When using aqueous agent, rinse the product with deionized water adequately and completely dry it so that no cleaner is left.

\* For other cleaning, consult our technical department.

**11.9 Storage and transportation**

Storage period	Use the product within 6 months after delivery. If you do not use the product for more than 6 months, check solderability before using it.
Storage conditions	<ul style="list-style-type: none"> <li>• The products shall be stored in a room not subject to rapid changes in temperature and humidity. The recommended temperature range is -10°C to +40°C. The recommended relative humidity range is 15% to 85%. Keeping the product in corrosive gases, such as sulfur, chlorine gas or acid may cause the poor solderability.</li> <li>• Do not place the products directly on the floor; they should be placed on a palette so that they are not affected by humidity or dust.</li> <li>• Avoid keeping the products in a place exposed to direct sunlight, heat or vibration.</li> <li>• Do not keep products in bulk packaging. Bulk storage could result in collisions between the products or between the products and other parts, resulting in chipping or wire breakage.</li> <li>• Avoid storing the product by itself bare (i.e. exposed directly to air).</li> </ul>
Transportation	Excessive vibration and impact reduces the reliability of the products. Exercise caution when handling the products.

**11.10 Resin coating (including moisture-proof coating)**

When the product is coated/molded with resin, its electrical characteristics may change.

A wire breakage issue may occur by mechanical stress caused by the resin, amount/cured shape of resin, or operating condition etc.

Some resins contain impurities or hydrolyzable chlorine, which could result in corrosion of the conducting materials, leading to wire breakage.

So, please pay your careful attention when you select resin in case of coating/molding the products with the resin.

Prior to use the coating resin, please make sure no reliability issue is observed by evaluating products mounted on your board.

**11.11 Mounting conditions**

Check the mounting condition before using.

Using mounting conditions (nozzles, equipment conditions, etc.) that are not suitable for products may lead to pick up errors, misalignment, or damage to the product.

**11.12 Operating environment**

Do not use this product under the following environmental conditions as it may cause deterioration of product quality.

- (1) In the corrodible atmosphere such as acidic gases, alkaline gases, chlorine, sulfur gases, organic gases and etc. (the sea breeze, Cl<sub>2</sub>, H<sub>2</sub>S, NH<sub>3</sub>, SO<sub>2</sub>, NO<sub>2</sub>, etc)
- (2) In the atmosphere where liquid such as organic solvent, may splash on the products.
- (3) In the atmosphere where the temperature/humidity changes rapidly and it is easy to dew.

**11.13 Mounting density**

If this product is placed near heat-generating products, be sure to implement sufficient heat-dissipating measures.

If this product is subjected to a significant amount of heat from other products, this could adversely affect product quality, resulting in a circuit malfunction or failure of the mounted section. Also, be sure that the product is used in a manner so that the heat that the product is subjected to from other products does not exceed the upper limit of the rated operating temperature for the product.

### 12. ⚠ Note

- (1) Please make sure that your product has been evaluated in view of your specifications with our product being mounted to your product.
- (2) You are requested not to use our product deviating from the reference specifications.
- (3) The contents of this reference specification are subject to change without advance notice.  
Please approve our product specifications or transact the approval sheet for product specifications before ordering.

### Appendix

Electrical performance: Measuring method for inductance/Q (Q measurement is applicable only when the Q value is included in the rating table.)

Perform measurement using the method described below. (Perform correction for the error deriving from the measuring terminal.)

- (1) Residual elements and stray elements of the measuring terminal can be expressed by the F parameter for the 2-pole terminal as shown in the figure below.

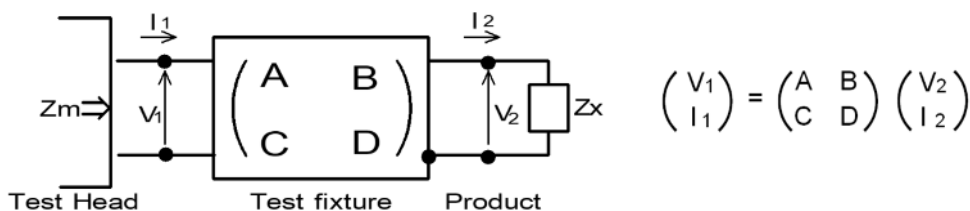

- (2) The product's impedance value ( $Z_x$ ) and measured impedance value ( $Z_m$ ) can be expressed as shown below, by using the respective current and voltage for input/output.

$$Z_m = \frac{V_1}{I_1} \quad Z_x = \frac{V_2}{I_2}$$

- (3) Thus, the relationship between the product's impedance value ( $Z_x$ ) and measured impedance value ( $Z_m$ ) is as follows.

$Z_x = \alpha \frac{Z_m - \beta}{1 - Z_m \Gamma}$	<p>Here,</p> <p><math>\alpha = D/A = 1</math></p> <p><math>\beta = B/D = Z_{sm} - (1 - Y_{om} Z_{sm}) Z_{ss}</math></p> <p><math>\Gamma = C/A = Y_{om}</math></p> <p><math>Z_{sm}</math>: measured impedance of short chip</p> <p><math>Z_{ss}</math>: residual impedance of short chip (0.556 nH)</p> <p><math>Y_{om}</math>: measured admittance when measuring terminal is open</p>
---	--

- (4) Calculate inductance  $L_x$  and  $Q_x$  using the equations shown below.

$L_x = \frac{\text{Im}(Z_x)}{2\pi f}$	<p><math>L_x</math>: inductance of chip coil</p>
$Q_x = \frac{\text{Im}(Z_x)}{\text{Re}(Z_x)}$	<p><math>Q_x</math>: Q of chip coil</p> <p><math>f</math>: measuring frequency</p>