



VMJ24493

Vehicular 3-Port MIMO Antenna

2400-2500 MHz/4900-6000 MHz/GNSS

The Laird Connectivity ground plane independent three-port MIMO antenna covers the 2400 to 2500 MHz and 4900 to 6000 MHz frequency ranges with an added global navigational antenna. Configured with two dual band Wi-Fi ports and a third port configured with a GNSS navigational antenna, the antenna is well suited for global applications where the need for Wi-Fi coverage is required.

Connector options include, but not limited to, a SMA male connector for the GNSS port and RPSMA male connectors for the Wi-Fi ports. The housing incorporates a low-profile, rugged design that conforms to IP67 standards. The antenna also features high impact, UV-resistant polycarbonate plastic radome available in black or white.

APPLICATIONS

- Passenger Fleet
- Commercial Vehicle Fleet
- Kiosk/Vending/Utilities
- Commercial Industrial

ELECTRICAL SPECIFICATION

Antenna Model	VMJ24493x	
Number of Ports	3	
Port Configuration (Label)	2x- WIFI, 1x-GNSS	
Operating Frequency (MHz)	2400-2500	4900-6000
Peak Gain - Average* (dBi)	4.7	6.3
Peak Gain - Max* (dBi)	5.1	6.9
Efficiency- Average* (%)	71	67
Efficiency, Max* (%)	76	71
VSWR- Average**	1.3	1.4
VSWR- Max**	2.0	2.0
Isolation** WIFI 1 to WIFI 2 (dB)	-20	-20
Nominal Impedance (Ohms)	50	
Max Power - Ambient 25°C (W)	50	
Polarization	Vertical Linear	
Horizontal Plane 3 dB Beamwidth	Omnidirectional	

* Measured on 1 ft (30.48 cm) diameter ground plane and 1ft (30.48 cm) of coaxial cable

** Measured on 1 ft (30.48 cm) diameter ground plane and 17 ft (51.8 cm) of coaxial cable Antenna specification is subjected to change according to the ground plane size

MECHANICAL SPECIFICATION

Dimensions - diameter x height - mm (in.)	127 x 38.5 (5.0 x 1.52)
Weight - kg (lbs)	0.58 (1.29)
Cable Type	LMR240
Mounting	P- Mount
Radome and Base Plate Material	PC, UL94 - V0 Rating, UV Stable

ENVIRONMENTAL SPECIFICATION

Operating Temperature - °C (°F)	-40 to +80 (-40 to +176)
Storage Temperature - °C (°F)	-40 to +85 (-40 to +185)
Ingress Protection Rating	IP67
Material Substance Compliance	RoHS

CONFIGURATION

PART NUMBER	CABLE LENGTH	CONNECTOR GNSS	CONNECTOR WI-FI PORT	COLOR	NAVIGATION
VMJ24493B-518RSMM	5.18m (17ft)	SMA Male	RPSMA Male	Black	GNSS
VMJ24493W-518RSMM	5.18m (17ft)	SMA Male	RPSMA Male	White	GNSS

GNSS ANTENNA SPECIFICATION

Model Number	VMJ24493x		
Number of Ports	1x- GNSS		
Frequency Band (MHz)	Beidou	GPS	GLONASS
Frequency of Operation (MHz)	1561.098 ± 2.046	1575.42 ± 1.023	1602.0 ± 5.0
Amplifier Gain (dB)	28 dB ± 3		
Nominal Impedance (Ohms)	50 Ω		
Output VSWR	< 2:1		
DC Voltage	2.5 - 7 Vdc		
Current Consumption, mA	8.5 ± 3 (at 3.0V)		
Input Max Power, dBm	-10		
Out of Band Rejection, dBc	80 (@ 698- 960 MHz), 80 (@ 1428- 1511 MHz) 50 @ (1627- 1638 MHz), 80 @ (1710- 2700 MHz) 70 (@ 4900- 5800 MHz)		
Working/Storage Temperature	-40°C - +85°C (-40°F - +185°F)		
Connector	SMA-Male		
Cable - Exposed Length	RG174-518.2 cm (17 ft.)		

PACKAGE INFORMATION

PACKAGE DIMENSIONS	CARTON	MASTER CARTON	AIR PALLET	OCEAN PALLT
Number of Antennas	1	4	96	120
Height- mm (in.)	125 (4.92)	305 (12.0)	1363 (53.66)	1668 (65.67)
Length- mm (in.)	290 (11.4)	525 (20.7)	1200 (47.24)	1200 (47.24)
Width- mm (in.)	255 (10.0)	265 (10.4)	800 (31.5)	800 (31.5)
Shipping Weight- kg (lb.)	1.2 (2.6)	5.6 (12)	146 (322)	180 (397)

MECHANICAL DRAWING

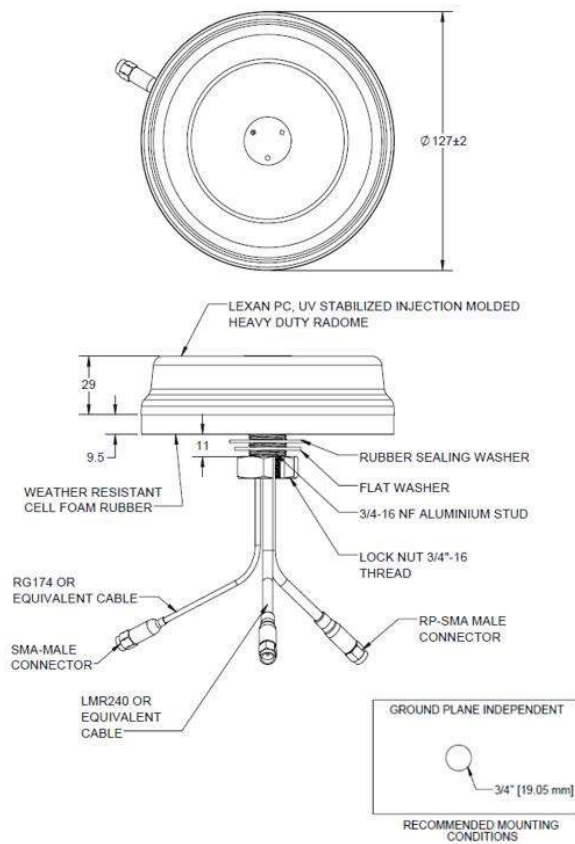

RADIATION PATTERNS- WIFI PORTS

2400 MHz

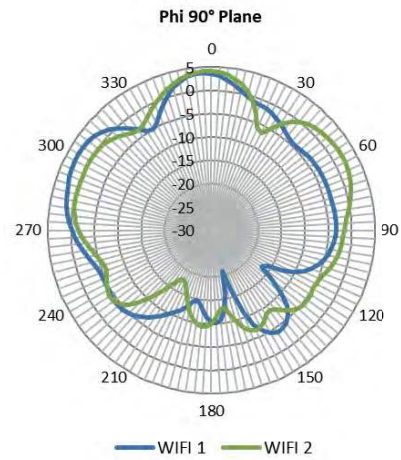
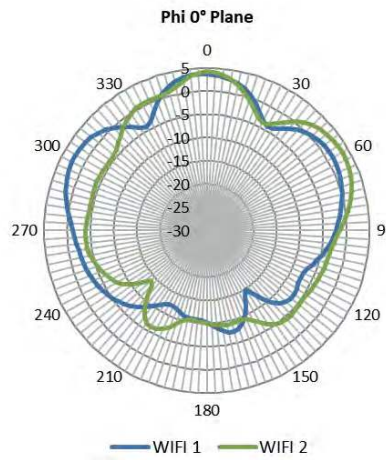
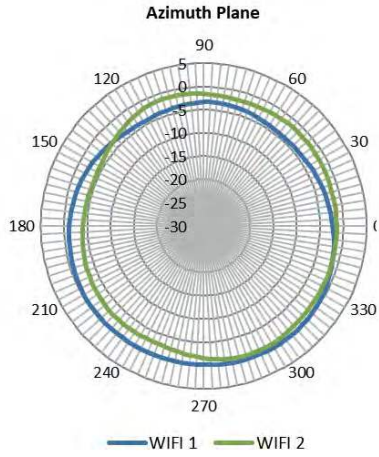

2450 MHz

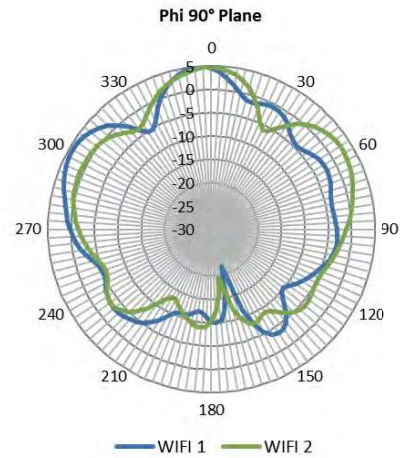
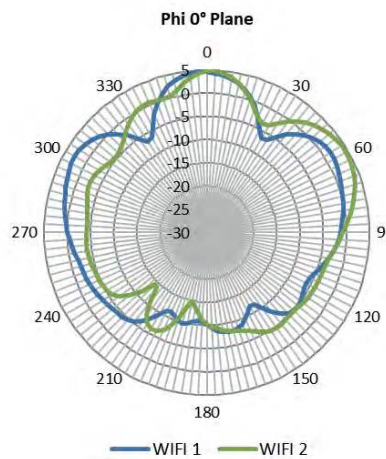
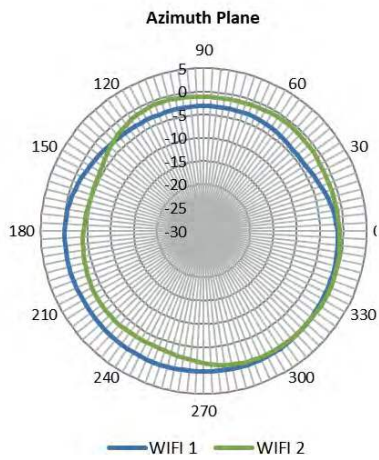

2500 MHz

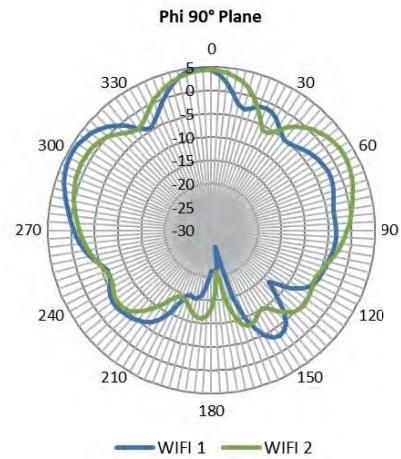
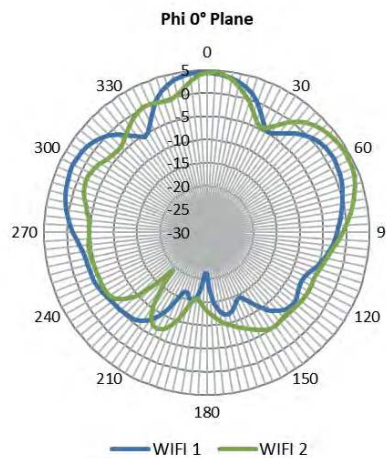
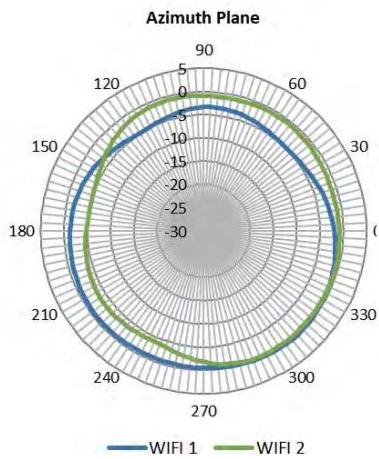

RADIATION PATTERNS- WIFI PORTS

4900 MHz

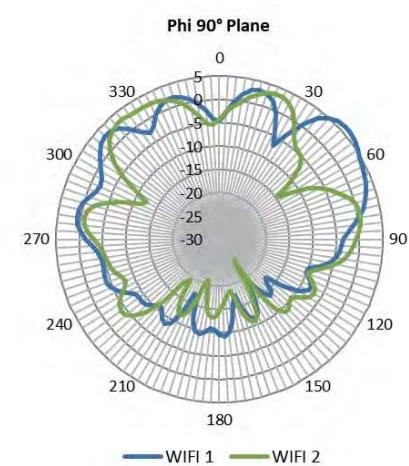
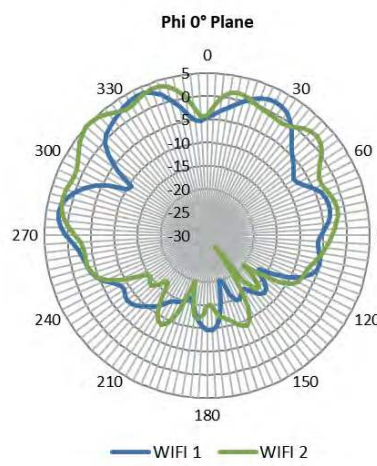
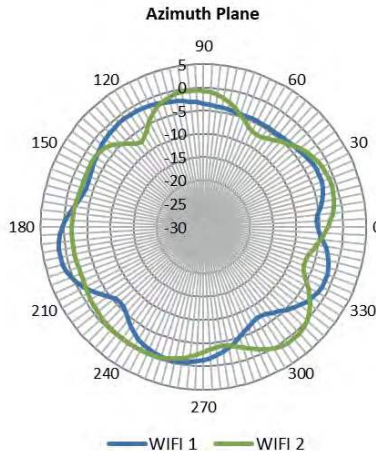

5470 MHz

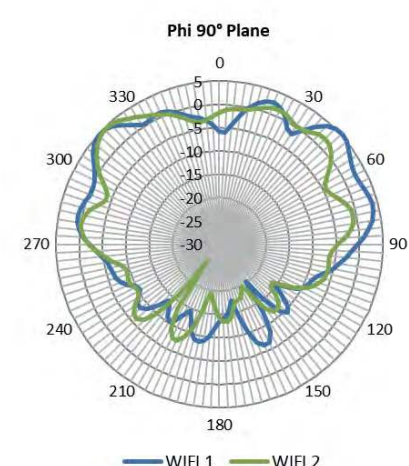
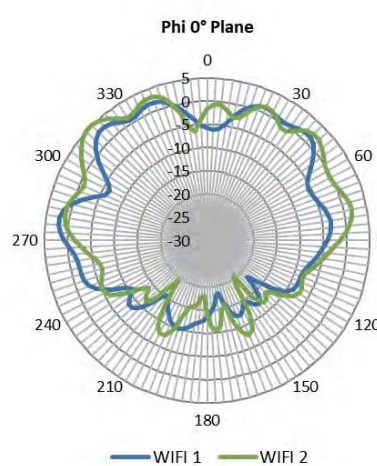
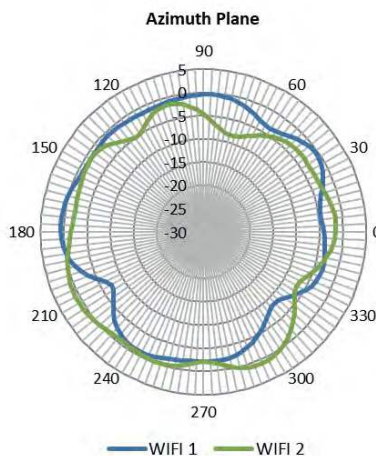

5725 MHz

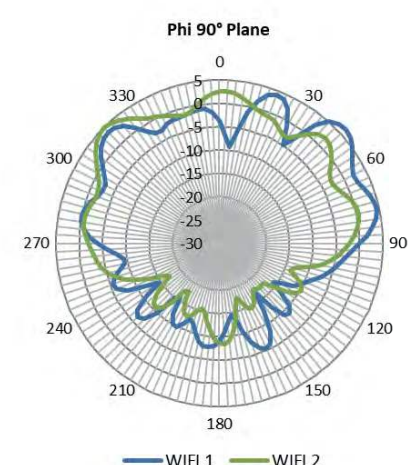
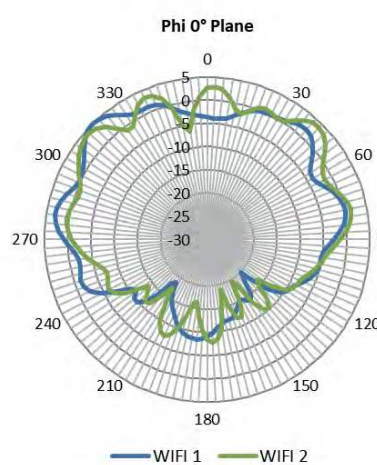
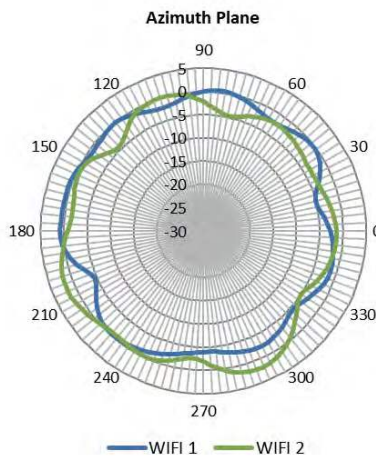

RADIATION PATTERNS- WIFI PORTS

5900 MHz

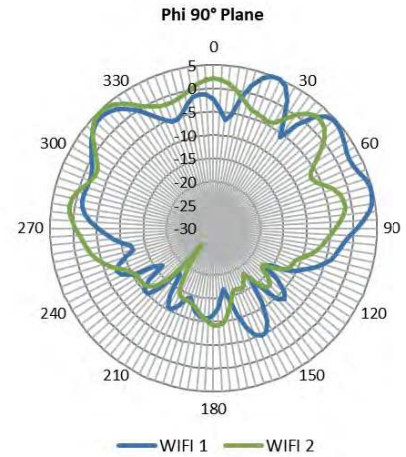
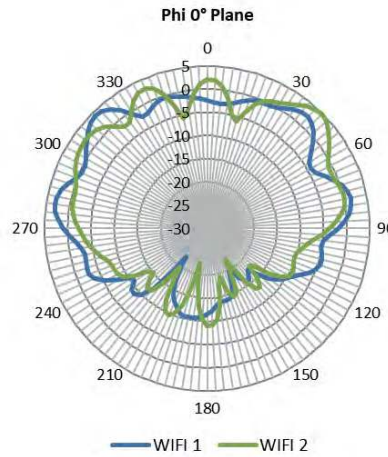
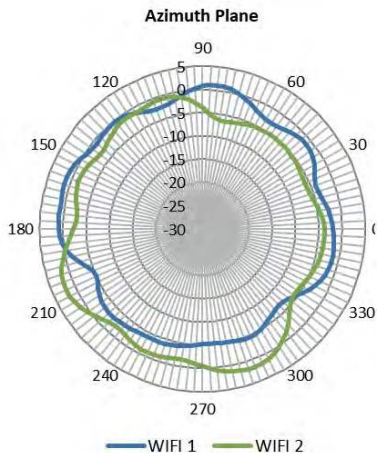

TE TECHNICAL SUPPORT CENTER

USA:	+1 (800) 522-6752
Canada:	+1 (905) 475-6222
Mexico:	+52 (0) 55-1106-0800
Latin/S. America:	+54 (0) 11-4733-2200
Germany:	+49 (0) 6251-133-1999
UK:	+44 (0) 800-267666
France:	+33 (0) 1-3420-8686
Netherlands:	+31 (0) 73-6246-999
China:	+86 (0) 400-820-6015

te.com

TE Connectivity, TE Connectivity (logo) and Every Connection Counts are trademarks. All other logos, products and/or company names referred to herein might be trademarks of their respective owners.

The information given herein, including drawings, illustrations and schematics which are intended for illustration purposes only, is believed to be reliable. However, TE Connectivity makes no warranties as to its accuracy or completeness and disclaims any liability in connection with its use.

TE Connectivity's obligations shall only be as set forth in TE Connectivity's Standard Terms and Conditions of Sale for this product and in no case will TE Connectivity be liable for any incidental, indirect or consequential damages arising out of the sale, resale, use or misuse of the product. Users of TE Connectivity products should make their own evaluation to determine the suitability of each such product for the specific application.

TE warrants to the original end user customer of its products that its products are free from defects in material and workmanship. Subject to conditions and limitations TE will, at its option, either repair or replace any part of its products that prove defective because of improper workmanship or materials. This limited warranty is in force for the useful lifetime of the original end product into which the TE product is installed. Useful lifetime of the original end product may vary but is not to exceed five (5) years from the original date of the end product purchase.

©2021 TE Connectivity. All Rights Reserved.

12/21 Original

