



ide for M53015EVB



M53015EVB
32-bit ColdFire MCU





Get to know the M53015EVB

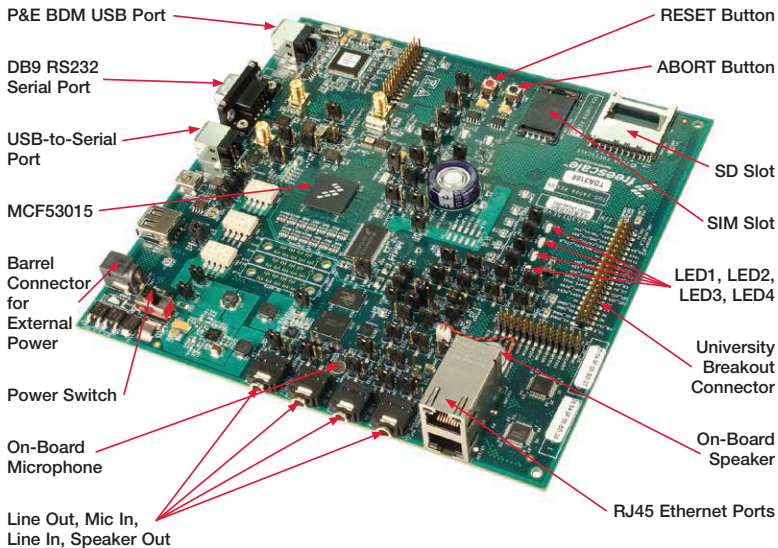



Introduction

In this Quick Start Guide, you will learn how to setup the Web server on the board and use the pre-loaded u-boot bootloader to boot the μ Clinux kernel with filesystem resident in flash.

In addition, this Quick Start Guide will provide a walk-through of how to play a sample MP3 from the USB flash mass storage device included in the kit, and also record and play back a voice WAV file from the included SD memory card.

Step-by-Step Installation Instructions

STEP 1

Connect the Power Connector

Plug the power connector into the barrel connector (J51) on the board. Power-on the board via the switch (SW6).

As the board autoboos μ Clinux, you will hear the welcome message from the board in a few seconds, shortly after the LED (D1) lights up.

Install the USB to Serial Driver, CP210x_VCP+Win2K_XP_S2K3.exe, found on the DVD. This will enable the board to communicate to a serial terminal.



Barrel Connector for External Power

Power Switch

STEP 2

Connect the USB Cable

Connect the USB cable from the PC to the Serial-to-USB connector (UART0) on J49.



STEP 3

Open HyperTerminal on the PC

Click Start Menu > Programs > Accessories > Communications > HyperTerminal.



STEP 4

Open and Configure HyperTerminal

Configure for 115200, 8 bits, no flow control, 1 stop bit.

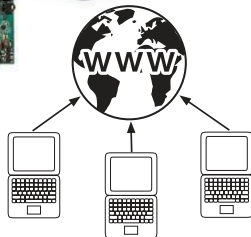
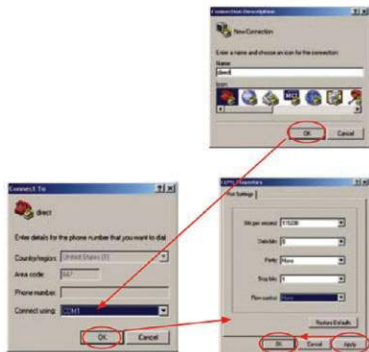
STEP 5

Connect an Ethernet Cable to the Network

If you would like to connect the board via a local network, connect an Ethernet cable between the network and the board via the bottom RJ45 jack. **(P2)** This Ethernet interface uses DHCP and will automatically get an IP address. Skip to Step 8.

To connect directly to a PC, continue to Step 6.

STEP
6

Connect an Ethernet Cable Between the PC and the Board

Connect an Ethernet cable between the PC and the board via the top RJ45 jack (**P2**).

STEP
7

If Necessary, Manually Setup TCP/IP on the PC

The default IP address of the board is **169.254.3.3**. Typically, when you connect your computer directly to the board, the computer will default to an auto IP address on the same subnet as the board (169.254.x.x), requiring no setup.

NOTE: The PC may take a few minutes to default to the auto IP address and make the connection.

If you have trouble connecting, configure the IP address of the computer manually via Start > Settings > Network Connections > Local Area Connection. Note your original TCP/IP settings, then set your IP address to **169.254.3.4** and your subnet mask to **255.255.0.0**.

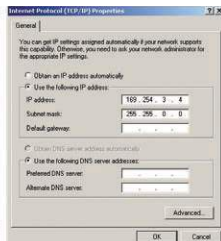
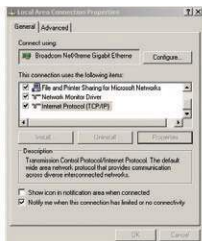
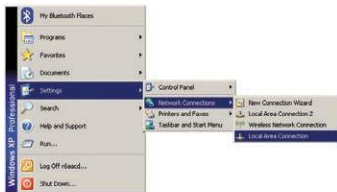

STEP 8 Confirm IP Address of Board

Now, go to the previously configured HyperTerminal window. At this point, the board would have already booted and you will have to hit “Enter” in order to see the “\$” prompt.

Now, type the command: **ifconfig** in order to verify your IP address for **eth0**, if you are connected to a local network, or **eth1**, if you are connected directly to a PC. The IP address for **eth1** will be **169.254.3.3**.

STEP 9

Open a Web Browser

Next, open a Web browser and go to the board's IP address, found in the previous step, to view the Web page that resides in the M53015EVB external flash memory.

This page is being served by the μ Clinux Boa server residing in external flash memory.



M53016EVB Featuring the ColdFire[®] MCF5301s Family

This page is being served up by the M53015EVB running μ Clinux and the Boa web server. A μ Clinux DSP (including this device) and the M53015EVB features the high performance, highly integrated MCF53015C/DSP. The M53015EVB development system provides an audio processing solution.

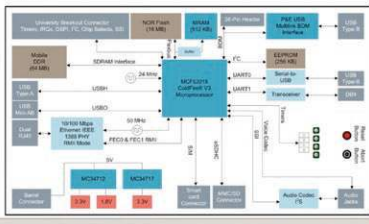

STEP 10

Insert the SD Memory Device

Insert the included SD memory device into the board's SD connector (**P1**). You will see μ Clinux automount the SD memory device, which is a new feature added to the standard ColdFire μ Clinux distribution. Hit "Enter" to see the command prompt.

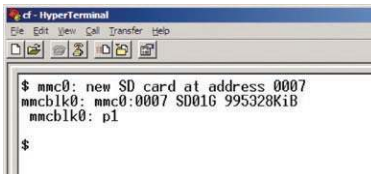

**STEP
11**

Record Your Voice

After the SD memory device has mounted, it is now ready to use. We will use the on-board microphone to record voice with the internal voice codec.



Microphone

Enlarged View

In HyperTerminal, type the command:
wrec -w -t 10 -s 8000 -b 16 -D /dev/dsp1 /mnt/sd/test.wav. Now, speak into the microphone for approximately 10 seconds.

-w	Record a Microsoft WAV file
-t seconds	Sets playback/recording time in seconds
-s speed	Sets sampling rate in Hz
-b bits	Sets sample size (bits per sample)
-D	Specifies device (i.e. internal voice codec)

STEP 12

Mount the USB Mass Storage Device

Next, type the command: **ls /mnt/sd.**
You will see the contents listed as:
test.wav.

```

$ wrec -w -t 10 -s 8000 -b 16 -D /dev/dsp1 /mnt/sd/test.wav
Recording WAVE : 16 bit, Speed 8000 Hz Mono ...
$ ls /mnt/sd
test.wav
$
    
```

Next, type the command: **vplay -t 10 -s 8000 -b 16 -D /dev/dsp1 /mnt/sd/test.wav** to play the file using the internal voice codec.

```

$ vplay -t 10 -s 8000 -b 16 -D /dev/dsp1 /mnt/sd/test.wav
Playing WAVE : 16 bit, Speed 8000 Hz Mono ...
$
    
```

You will hear your voice audio from the on-board speaker.

Before moving on, please move the blue jumpers J3 and J4 on the board to position 2-3. Moving these jumpers connects the external codec to the on-board speaker instead of the internal. For further details of the internal and external codecs, please refer to the M53015EVb User's Manual.

Insert the included USB mass storage device into the board's USB Type A receptacle (**J50**). You will see the device automount the USB mass storage device, which is a new feature added to the standard ColdFire μ Clinux distribution. Hit "Enter" to see the command prompt.

```

BusyBox v1.11.2 () built-in shell (ash)
Enter 'help' for a list of built-in commands.

$ usb l-1: new full speed USB device using fsl-ehci and address 2
usb l-1: configuration #1 chosen from 1 choice
scsi0 : SCSI emulation for USB Mass Storage devices
scsi 0:0:0:0: Direct-Access: TREQ InaDrive G3 1.11 PQ: 0 ANSI: 2
sd 0:0:0:0: sdal 64512 512-byte hardware sectors (33 MB)
sd 0:0:0:0: sdal Write Protect is off
sd 0:0:0:0: sdal Assuming drive cache: write through
sd 0:0:0:0: sdal 64512 512-byte hardware sectors (33 MB)
sd 0:0:0:0: sdal Write Protect is off
sd 0:0:0:0: sdal Assuming drive cache: write through
sd: sdal
sd 0:0:0:0: sdal Attached SCSI removable disk

$
$
$
    
```

STEP
13

Hear the Music

After the USB mass storage device has initialized and attached, it is now ready to use. In HyperTerminal using the kernel prompt, type the command: **ls /mnt/usb**. You will see the contents listed as: **sample1.mp3*** and **sample2.mp3***. Now, type the command: **mp3play/mnt/usb/sample1.mp3**.

You will hear the music play from the on-board speaker.

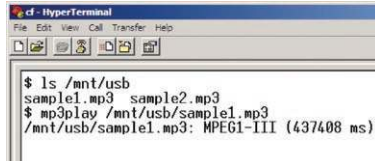
A screenshot of a HyperTerminal window titled "cf - HyperTerminal". The window has a menu bar with "File", "Edit", "View", "Call", "Transfer", and "Help". Below the menu bar is a toolbar with several icons. The terminal area shows the following text:

```
$ ls /mnt/usb
sample1.mp3  sample2.mp3
$ mp3play /mnt/usb/sample1.mp3
/mnt/usb/sample1.mp3: MPEG1-III (437408 ms)
```

*Nile's Blues, Kevin MacLeod (incompetech.com)
Licensed under Creative Commons "Attribution 3.0"
<http://creativecommons.org/licenses/by/3.0/>

** Rocket, Kevin MacLeod (incompetech.com)
Licensed under Creative Commons "Attribution 3.0"
<http://creativecommons.org/licenses/by/3.0/>



CodeWarrrior Stationary Quick Start

This Quick Start explains how to create, build, and run a sample project using the M53015EVb with CodeWarrrior.

STEP
1

Create new project

a. Select **Start > Programs > Freescale CodeWarrrior > CodeWarrrior for ColdFire V7.2 > CodeWarrrior IDE** from task bar. IDE starts and the CodeWarrrior **Startup** dialog box appears

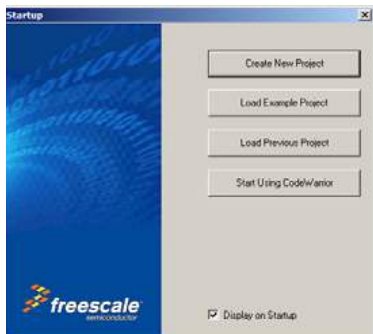

b. Select **Create New Project > Device and Connection** window appears

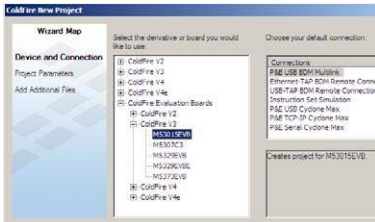

c. Select **ColdFire Evaluation Boards > ColdFire V3 > M53015EVb**

d. Select **P&E USB BDM Multilink**



e. Click **Next. Project Parameters** window appears



f. Choose **C**

g. Enter a project name in **Project name** text box. The software automatically creates a folder with the same name in the default location, or click **Set** to browse and select an alternate location for your project

h. Click **Next. Add Additional Files** window appears

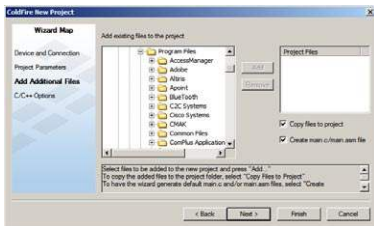

i. Click **Next. C/C++ Options** window appears

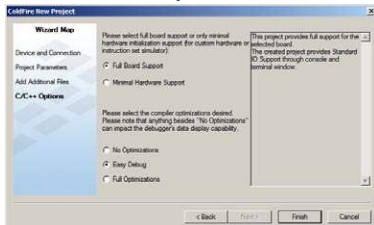

j. Click **Finish**. Software creates your project according to your specifications

STEP 2

Connect

Connect **USB cable** to **J48** and **RS-232 cable** to **J52 connectors** on the board. Ensure **J5** and **J8** jumpers are on **position 1-2**.

STEP 3

Build and Run Project

a. Select **EXTERNAL_RAM** Target; From main menu bar, select **Project > Make** — updates files and links code into application

b. From main menu bar, select **Project > Debug** — builds project, debug window appears

```

MS3015EV3_EXTERNAL_RAMLeif (Thread 0x0)
Stack
status
main
Variables List
No local variables

Source: D:\Profiles\va6200\My Documents\MS3015EV3\source\main.c
/*
 * main implementation: use this sample to create your own appli
 *
 */
#include "support_common.h" /* include peripheral declarations */
#ifdef (CONSOLE_IO_SUPPORT || ENABLE_WART_SUPPORT)
/* Standard IO is only possible if Console or WART support is en
#include (stdio.h)
#endif

int main(void)
+
    int source = 0;

```

c. Open Terminal Window configured for 19200, 8 bits, no flowcontrol, 1 stop bit

d. From main menu bar, select **Project > Run** — debugger downloads program to board and runs program

e. Terminal Window shows *Hello World* output

f. From main menu bar, select **Debug > Kill** — debug session ends. You may close all open windows

Congratulations!

You just used CodeWarrior software to create, build and run a simple program.



ide for M53015EVB



Learn more at www.freescale.com/coldfire.

Freescale, the Freescale logo, CodeWarrior and ColdFire are trademarks or registered trademarks of Freescale Semiconductor, Inc. in the U.S. and other countries Reg. U.S. Pat. & Tm. Off. All other product or service names are the property of their respective owners. © Freescale Semiconductor, Inc. 2010.

Doc Number: M53015EVBQSG / REV 0
Agile Number: 926-78396 / REV A

